

IMPORTANT

READ CAREFULLY BEFORE USE

KEEP SAFE TO CONSULT AT A LATER DATE



FIT



Original operating instructions for BULLS pedelecs with BROSE FIT Remote LCD

E-Stream EVA 1, E-Stream EVA TR1, E-Stream EVA TR2, E-Stream EVO 1, E-Stream EVO 1,
E-Stream EVO 2 Street, E-Stream EVO AM 2, E-Stream EVO AM 3, E-Stream EVO AM 4,
E-Stream EVO TR1, Lacuba EVO Cross

22-15-1033, 22-15-1034, 22-18-1001, 22-18-1004, 22-18-1005, 22-18-1056 ... 22-18-1058,
22-18-1060, 22-18-1061, 22-18-2007

Contents

1	About these operating instructions	
1.1	Manufacturer	12
1.2	Laws, standards and directives	12
1.3	Language	12
1.4	For your information	12
1.4.1	Warnings	12
1.4.2	Markups	12
1.5	Aim of the operating instructions	13
1.6	Type number and model	14
1.7	Frame number	14
1.8	Identifying the operating instructions	14
2	Safety	
2.1	Residual risk	15
2.1.1	Risk of fire and explosion	15
2.1.2	Electric shock	17
2.1.3	Risk of a crash	17
2.1.4	Risk of amputation	17
2.1.5	Key breaking off	17
2.1.6	Malfunctions due to Bluetooth®	18
2.2	Toxic substances	19
2.2.1	Carcinogenic substances	19
2.2.2	Toxic substances	19
2.2.3	Irritants and corrosive substances	19
2.3	Requirements for the pedelec rider	20
2.4	Vulnerable groups	20
2.5	Personal protective equipment	20
2.6	Safety guards	20
2.7	Safety markings and safety instructions	21
2.8	What to do in an emergency	21
2.8.1	Dangerous situation in road traffic	21
2.8.2	Leaked brake fluid	21
2.8.3	Battery vapour emission	22
2.8.4	Battery fire	22
2.8.5	Oil and lubricant leaks from the rear frame damper	22
2.8.6	Oil and lubricant leaks from the fork	22
3	Description	
3.1	Proper use	23
3.1.1	Improper use	24
3.1.2	Permitted total weight (PTW)	25
3.1.3	Environmental requirements	26
3.2	Nameplate	28
3.3	Components	29
3.3.1	Overview	29
3.3.2	Chassis	30
3.3.2.1	Frame	30
3.3.2.2	Steering system	30
3.3.2.3	Steering headset	30
3.3.2.4	Stem	30
3.3.2.5	Handlebars	31
3.3.2.6	Fork	31
3.3.3	Suspension	32
3.3.3.1	Rigid fork	32
3.3.3.2	Suspension fork	32

3.3.4	Wheel	36
3.3.4.1	Tyres	36
3.3.4.2	Tube-type tyre	36
3.3.4.3	Rim	39
3.3.4.4	Valve	39
3.3.4.5	Spoke	39
3.3.4.6	Spoke nipples	39
3.3.4.7	Hub	40
3.3.5	Braking system	41
3.3.5.1	Mechanical brake	41
3.3.5.2	Hydraulic brake	41
3.3.5.3	Disc brake	42
3.3.6	Saddle	43
3.3.7	Seat post	43
3.3.7.1	Patent seat post	43
3.3.7.2	Suspension seat post	44
3.3.8	Mechanical drive system	45
3.3.8.1	Chain drive layout	45
3.3.8.2	Belt drive layout	45
3.3.9	Electric drive system	46
3.3.9.1	Motor	46
3.3.10	Rechargeable battery	47
3.3.10.1	Riding light	47
3.3.10.2	Charger	47
3.3.10.3	On-board computer	48
3.4	Description of controls and screens	49
3.4.1	Handlebars	49
3.4.2	On-board computer	50
3.4.2.1	SELECTION MENU	51
3.4.2.2	DRIVE MAIN MENU	52
3.4.2.3	DRIVE SUB-MENU 1	53
3.4.2.4	DRIVE SUB-MENU 2	54
3.4.2.5	TRIP DISTANCE	54
3.4.2.6	TRIP TIME	55
3.4.2.7	TRIP HEIGHT	55
3.4.2.8	TOTAL	56
3.4.2.9	CURRENT ALTITUDE	56
3.4.2.10	CADENCE	57
3.4.2.11	PULSE	57
3.4.2.12	NAVI	58
3.4.2.13	PRESSURE	58
3.4.2.14	SETTINGS MENU	59
3.4.2.15	Error message	60
3.4.3	SHIMANO gear shift	61
3.4.3.1	3-switch switch control panel	61
3.4.3.2	2-switch switch control panel	61
3.4.3.3	MTB switch control panel	61
3.4.3.4	Switch control panel functions on right	61
3.4.3.5	Shifter SL-M5100	61
3.4.3.6	Shifter SL-M8100	62
3.4.4	Handbrake	63
3.4.5	Fork lock	64
3.4.5.1	SR Suntour	64
3.4.6	Indicators on the battery	65
3.4.6.1	Battery Level indicator screen	65
3.5	Technical data	66
3.5.1	Pedelec	66
3.5.2	BROSE Drive S- Mag Pro motor	66
3.5.3	BROSE Drive S-Mag Plus motor	66

3.5.4	FIT Remote LCD on-board computer	66
3.5.5	Emissions	66
3.5.6	Rechargeable battery	67
3.5.6.1	UltraCore FIT 555 Wh	67
3.5.6.2	UltraCore FIT 740 Wh	67
3.5.6.3	UltraCore FIT 925 Wh	67
3.5.7	Saddle width	68
3.5.7.1	BROOKS ENGLAND	68
3.5.7.2	ERGON	68
3.5.7.3	SELLE ROYAL	68
3.5.8	Puncture protection level	69
3.5.8.1	SCHWALBE	69
3.5.8.2	SUPERO	70
3.5.8.3	MAXXIS®	71
3.5.9	Torque	72
4	Transporting and storing	
4.1	Weight and dimensions for transportation	79
4.2	Designated handles, lifting points	79
4.3	Transportation	80
4.3.1	Using the transport securing system	80
4.3.2	Transporting the pedelec	80
4.3.2.1	By car	80
4.3.2.2	By train	80
4.3.2.3	By local transport	81
4.3.2.4	By long-distance bus	81
4.3.2.5	On flights	81
4.3.3	Shipping a pedelec	81
4.3.4	Transporting the battery	81
4.3.5	Shipping the battery	81
4.4	Storing	82
4.4.1	Battery storage mode	82
4.4.2	Break in operation	82
4.4.2.1	Preparing a break in operation	82
4.4.2.2	Carrying out a break in operation	82
5	Assembly	
5.1	Unpacking	83
5.2	Required tools	83
5.3	Commissioning	84
5.3.1	Checking the battery	84
5.3.2	Preparing the wheel	85
5.3.3	Installing the wheel in the SUNTOUR fork	86
5.3.3.1	Screw-on axle (12AH2 and 15AH2)	86
5.3.3.2	20 mm cross axle	87
5.3.3.3	Q-LOC quick release	89
5.3.4	Preparing the LIMOTEC seat post	90
5.4	Preparing the battery	91
5.4.1	Checking the battery	91
5.4.2	Retrofitting the battery locking lever	91
5.4.2.1	Preparing the frame	91
5.4.2.2	Fitting the locking lever	91
5.4.3	Fitting the pedals	92
5.4.4	Checking the stem and handlebars	93
5.4.4.1	Checking the connections	93
5.4.4.2	Checking stem is firmly in position	93
5.4.4.3	Checking the bearing clearance	93
5.5	Selling the pedelec	93

6 Operation

6.1	Risks and hazards	94
6.2	Tips for a greater range	96
6.3	Error message	97
6.3.1	Display	97
6.3.1.1	Status LED	97
6.3.1.2	Warnings	97
6.3.1.3	Error messages	98
6.3.2	UltraCore battery	106
6.3.3	Operating element	106
6.4	Instruction and customer service	107
6.5	Adjusting the pedelec	107
6.5.1	Preparing	107
6.5.2	Pedelec adjustment procedure	108
6.5.3	Riding position	109
6.5.4	Saddle	111
6.5.4.1	Replacing the saddle	111
6.5.4.2	Determining saddle shape	111
6.5.4.3	Determining minimum saddle width with corrugated cardboard	113
6.5.4.4	Determining minimum saddle width with gel cushion	113
6.5.4.5	Calculating the saddle width	114
6.5.4.6	Selecting the saddle hardness	114
6.5.4.7	Adjusting the saddle hardness	114
6.5.4.8	Straighten saddle	114
6.5.4.9	Positioning the saddle with eightpins suspension seat post	114
6.5.4.10	Adjusting the saddle height	115
6.5.4.11	Setting the saddle height with the remote control	116
6.5.4.12	Adjusting the saddle position	117
6.5.4.13	Adjusting the saddle tilt	117
6.5.4.14	Checking saddle stability	117
6.5.5	Handlebars	118
6.5.5.1	Replace handlebars	118
6.5.5.2	Adjusting the handlebar width	118
6.5.5.3	Adjusting the hand position	118
6.5.5.4	Adjusting the handlebars	119
6.5.6	Stem	120
6.5.6.1	Replacing the handlebars	120
6.5.6.2	Adjusting the handlebar height with quick release	120
6.5.6.3	Checking the stem stability	120
6.5.6.4	Adjusting the quick release clamping force	120
6.5.6.5	Setting the quill stem	121
6.5.6.6	Adjusting the Ahead stem	121
6.5.6.7	Adjusting the angle-adjustable stem	122
6.5.7	Handles	123
6.5.7.1	Replacing the handles	123
6.5.7.2	Adjusting ergonomic handles	123
6.5.7.3	Checking handlebar stability	123
6.5.8	Tyres	124
6.5.8.1	Adjust tyre pressure	124
6.5.8.2	Replacing tyres	125
6.5.9	Brake	126
6.5.9.1	Change handbrake position	126
6.5.9.2	Change handbrake inclination angle	126
6.5.9.3	Determining the grip distance	127
6.5.9.4	Grip distance on a SHIMANO ST-EF41 handbrake	128
6.5.9.5	Replacing brakes	129
6.5.9.6	Retracting the brake linings	129
6.5.10	Gear shift	130
6.5.10.1	Replacing the gear shift	130
6.5.10.2	Adjusting the SHIMANO shifter	130

6.5.11	Suspension	131
6.5.12	Fork sag	131
6.5.12.1	Adjusting the SR SUNTOUR fork steel suspension	132
6.5.12.2	Adjusting the SR SUNTOUR fork air suspension	133
6.5.13	Fork rebound damping	134
6.5.13.1	Adjusting the SR SUNTOUR fork rebound damping	135
6.5.14	Riding light	136
6.5.14.1	Adjusting the headlight	137
6.5.15	On-board computer	138
6.5.15.1	Switching on the on-board computer	138
6.5.15.2	Operating the display	138
6.5.15.3	SELECTION MENU	139
6.5.15.4	Changing the settings	139
6.5.15.5	Setting the language	140
6.5.15.6	Adjusting the clock	140
6.5.15.7	Setting the date	140
6.5.15.8	Setting units	140
6.5.15.9	Setting the time format	140
6.5.15.10	Connecting the Komoot app	141
6.5.15.11	Connecting the heart rate sensor	141
6.5.15.12	Adjusting the assistance system	141
6.5.15.13	Calibrating the altimeter	141
6.5.15.14	Adjusting the backlight	141
6.5.15.15	Adjusting the auto switch-off	141
6.5.15.16	Adjusting the vibration feedback	142
6.5.15.17	Adjusting the charge mode	142
6.5.15.18	Resetting all tour data	142
6.5.15.19	Resetting to factory settings	142
6.5.15.20	Displaying error messages	142
6.5.15.21	Displaying the software version	142
6.6	Accessories	143
6.6.1	Child seat	143
6.6.2	Trailer	144
6.6.2.1	Approval for trailer with Enviolo hub	144
6.6.2.2	Approval for trailer with ROHLOFF hub	145
6.6.3	Mobile holder	145
6.6.4	Tubeless and airless tyres	145
6.6.5	Suspension fork coil spring	145
6.6.6	Pannier rack	146
6.6.7	Panniers and cargo boxes	146
6.7	Personal protective equipment and accessories for road safety	147
6.8	Before each ride	147
6.9	Straightening the quickly adjustable stem	148
6.10	Using the pannier rack	148
6.11	Raising the kickstand	149
6.12	Using the saddle	149
6.12.1	Using the leather saddle	149
6.13	Using the pedals	149
6.14	Using the bell	149
6.15	Using the handlebars	150
6.15.1	Using multi-position handlebars	150
6.15.2	Using bar ends	150
6.15.3	Using leather handles	150
6.16	Using the battery	151
6.16.1	Removing the battery	151
6.16.2	Inserting the battery	151
6.16.3	Charging the battery	152
6.17	Using the electric drive system	153
6.17.1	Switching on the electric drive system	153
6.17.2	Switching off the electric drive system	153

6.18	Using the on-board computer	154
6.18.1	Using the push assist system	154
6.18.2	Using the riding light	154
6.18.3	Selecting the level of assistance	155
6.18.4	Using the boost function	155
6.19	Using the brake	156
6.19.1	Use handbrake	156
6.19.2	Using the back-pedal brake	156
6.20	Use suspension and damping	157
6.20.1	Adjusting the SR SUNTOUR compression adjuster	158
6.21	Gear shift	159
6.21.1	Using the derailleur gears	159
6.21.2	Use SHIMANO hub gear	160
6.21.3	Using eShift	161
6.21.3.1	Using eShift with SHIMANO DI2 automatic hub gears	161
6.21.3.2	Using eShift with manual SHIMANO DI2 hub gears	161
6.21.3.3	Using eShift with SHIMANO DI2 automatic hub gears	161
6.22	Parking	162
6.22.1	Screwing in the All Up handlebars	163
7	Cleaning, servicing and inspection	
7.1	Before each ride	168
7.1.1	Checking the guards	168
7.1.2	Checking the frame	168
7.1.3	Checking the fork	168
7.1.4	Checking the rear frame damper	168
7.1.5	Checking the pannier rack	168
7.1.6	Checking the mudguards	168
7.1.7	Check wheel concentricity	168
7.1.8	Checking the quick releases	168
7.1.9	Checking the suspension seat post	169
7.1.10	Checking the bell	169
7.1.11	Checking the handles	169
7.1.12	Checking the USB cover	169
7.1.13	Checking the riding light	169
7.1.14	Checking the brake	169
7.2	After each ride	170
7.2.1	Cleaning the riding light and reflectors	170
7.2.2	Cleaning the suspension fork	170
7.2.3	Caring for the suspension fork	170
7.2.4	Cleaning the pedals	170
7.2.5	Cleaning the brake	170
7.2.6	Cleaning the suspension seat post	170
7.2.7	Cleaning the rear frame damper	170
7.3	Basic cleaning	171
7.3.1	Clean on-board computer and control panel	171
7.3.2	Cleaning the battery	171
7.3.3	Cleaning the motor	171
7.3.4	Clean Frame, fork, pannier rack, guards and kickstand	172
7.3.5	Cleaning the stem	172
7.3.6	Cleaning the handlebars	172
7.3.7	Clean handles	172
7.3.7.1	Cleaning leather handles	172
7.3.8	Clean seat post	172
7.3.9	Cleaning the saddle	173
7.3.9.1	Cleaning the leather saddle	173
7.3.10	Cleaning the tyres	173
7.3.11	Cleaning the spokes and spoke nipples	173
7.3.12	Clean hub	173

7.3.13	Cleaning the switching elements	173
7.3.13.1	Cleaning the shifter	173
7.3.14	Clean cassette, chain wheels and front derailleur	173
7.3.15	Clean brake	174
7.3.15.1	Clean handbrake	174
7.3.16	Cleaning the brake disc	174
7.3.17	Cleaning the belt	174
7.3.18	Cleaning the chain	174
7.3.18.1	Clean chain, including all-round chain guard	174
7.4	Servicing	175
7.4.1	Frame	175
7.4.2	Fork	175
7.4.3	Pannier rack	176
7.4.4	Mudguard	176
7.4.5	Servicing the kickstand	176
7.4.6	Stem	176
7.4.7	Handlebars	176
7.4.8	Handle	176
7.4.8.1	Rubber handles	176
7.4.8.2	Leather handle	176
7.4.9	Seat post	177
7.4.9.1	Suspension seat post	177
7.4.9.2	Carbon seat post	177
7.4.10	Rim	177
7.4.11	Leather saddle	177
7.4.12	Hub	177
7.4.13	Spoke nipples	177
7.4.14	Gear shift	178
7.4.14.1	Rear derailleur articulated shafts and jockey wheels	178
7.4.14.2	Shifter	178
7.4.15	Pedal	178
7.4.16	Caring for the chain	178
7.4.16.1	Caring for the chain and all-round chain guard	179
7.4.17	Caring for the battery	179
7.4.18	Caring for the brake	179
7.4.18.1	Caring for handbrake	179
7.4.19	Lubricating the Eightpins seat post tube	179
7.5	Inspection	180
7.5.1	Checking the wheel	180
7.5.1.1	Checking tyre pressure	180
7.5.1.2	Checking the tyres	182
7.5.1.3	Checking the rims	183
7.5.1.4	Checking the nipple holes	183
7.5.1.5	Checking the nipple well	183
7.5.1.6	Checking the rim hooks	183
7.5.1.7	Checking the spokes	183
7.5.2	Checking the brake system	184
7.5.2.1	Checking the handbrake	184
7.5.2.2	Checking the hydraulic brake system	184
7.5.2.3	Checking the Bowden cables	184
7.5.2.4	Checking the disc brake	185
7.5.2.5	Checking the back-pedal brake	186
7.5.2.6	Checking the rim brake	187
7.5.3	Checking the chain	188
7.5.4	Checking the chain tension	188
7.5.4.1	Check tension in derailleur gears	188
7.5.4.2	Check tension in hub gear	188
7.5.5	Checking the belt for wear	188
7.5.5.1	Rough check	188
7.5.5.2	Check	189

7.5.6	Checking the belt	190
7.5.7	Checking the belt for wear	190
7.5.8	Checking the belt sprockets for wear	190
7.5.9	Check belt tension	190
7.5.9.1	Gates Carbon Drive mobile app	191
7.5.9.2	Gates Krikit tension meter	191
7.5.9.3	ECO tension tester	192
7.5.10	Checking the riding light	193
7.5.11	Checking the stem	194
7.5.12	Checking the handlebars	194
7.5.13	Checking the saddle	194
7.5.14	Checking the seat post	194
7.5.14.1	Checking the derailleur gears	194
7.5.14.2	Checking the hub gear	195
7.5.15	Check gear shift	195
7.5.15.1	Electric gear shift	195
7.5.15.2	Mechanical gear shift	195
7.5.15.3	Checking the derailleur gears	196
7.5.16	Adjusting gear shift	196
7.5.16.1	Adjusting the ROHLOFF hub	196
7.5.17	Adjusting cable-operated gear shift, dual-cable	196
7.5.18	Adjusting Bowden-cable-operated twist grip, dual-cable	197
7.5.19	Checking kickstand stability	197

8 Inspection and maintenance

8.1	Initial inspection	198
8.2	Major inspection	198
8.3	Component-specific maintenance	198
8.4	Carry out initial inspection	201
8.5	Inspection and maintenance instructions	202
8.5.1	Inspecting the frame	209
8.5.1.1	Inspect the carbon frame	209
8.5.2	Inspecting the pannier rack	209
8.5.3	Inspect and maintain rear frame damper	209
8.5.4	Inspect gear hub	210
8.5.4.1	Adjusting the hub with cone bearing	210
8.5.5	Inspecting the stem	210
8.5.6	Inspect and grease steering headset	210
8.5.7	Inspecting axle with quick release	211
8.5.8	Inspecting the fork	212
8.5.8.1	Inspect the carbon suspension fork	212
8.5.8.2	Inspect the suspension fork	212
8.5.9	Inspecting the seat post	213
8.5.9.1	Inspect carbon seat post	213
8.5.9.2	Inspecting and greasing BY.SCHULZ suspension seat post	214
8.5.9.3	Inspecting and greasing RS SUNTOUR suspension seat post	214
8.5.9.4	FOX component-specific maintenance	215

9 Troubleshooting, fault clearance and repair

9.1	Preventing pain	216
9.1.1	Sitting discomfort	217
9.1.2	Pain in hips	217
9.1.3	Backache	217
9.1.4	Pain in shoulders and nape of neck	218
9.1.5	Numb or aching hands	218
9.1.6	Pain in upper thigh	218
9.1.7	Knee pain	219
9.1.8	Pain in the foot	219

9.2	Troubleshooting and fault clearance	220
9.2.1	The electric drive system or display do not start up	220
9.2.2	Warning messages and LEDs	220
9.2.3	Errors in the assistance system	220
9.2.4	Battery error	222
9.2.5	On-board computer error	223
9.2.6	Riding light does not work	223
9.2.7	Other electric drive system errors	224
9.2.8	Problems with freewheel	225
9.2.9	Problems with hub gear	226
9.2.10	Problems with disc brakes	228
9.2.11	Problems with rim brakes	229
9.2.12	Problems with back-pedal brake	230
9.2.13	SR SUNTOUR suspension fork	231
9.2.13.1	Rebound too fast	231
9.2.13.2	Rebounding too slowly	232
9.2.13.3	Suspension too soft on inclines	233
9.2.13.4	Excessively hard damping on bumps	234
9.2.14	RockShox suspension fork	235
9.2.14.1	Rebound too fast	235
9.2.14.2	Rebounding too slowly	236
9.2.14.3	Suspension too soft on inclines	237
9.2.14.4	Excessively hard damping on bumps	238
9.2.15	Rear frame damper	239
9.2.15.1	Rebound too fast	239
9.2.15.2	Rebounding too slowly	240
9.2.15.3	Suspension too soft on inclines	241
9.2.15.4	Excessively hard damping on bumps	242
9.2.16	RockShox rear frame damper	243
9.2.16.1	Rebound too fast	243
9.2.16.2	Rebounding too slowly	244
9.2.16.3	Suspension too soft on inclines	245
9.2.16.4	Excessively hard damping on bumps	246
9.2.17	Other errors	247
9.3	Repair	248
9.3.1	Original parts and lubricants	248
9.3.2	Repairing the frame	248
9.3.2.1	Removing paint damage on frame	248
9.3.2.2	Removing damage from impact on the carbon frame	248
9.3.3	Repairing the suspension fork	248
9.3.3.1	Removing paint damage on the fork	248
9.3.3.2	Removing damage from impact on the carbon frame	248
9.3.3.3	Repairing the seat post	248
9.3.3.4	Repairing damage from impact on the carbon post seat post	248
9.3.4	Replacing the riding light	249
9.3.5	Adjusting the headlight	249
9.3.6	Checking suspension fork-tyre clearance	249
10	Recycling and disposal	
10.1	Guidelines on removal of waste	250
11	Documents	
11.1	Assembly report	252
11.2	Inspection and maintenance log	254
11.3	Parts list	258
11.3.1	E-Stream EVA 1 27.5"	258
11.3.2	E-Stream EVA TR1 27.5"	260
11.3.3	E-Stream EVA TR2 27.5"	262
11.3.4	E-Stream EVO 1 29"	264

11.3.5	E-Stream EVO 2 Street 27.5"	266
11.3.6	E-Stream EVO AM 2 29"	268
11.3.7	E-Stream EVO AM 3 29"	270
11.3.8	E-Stream EVO AM 4 29"	272
11.3.9	Lacuba EVO Cross	274
12	Glossary	
12.1	Abbreviations	279
12.2	Simplified terms	279
13	Appendix	
I.	Translation of the original EC/EU Declaration of Conformity	280
II.	Declaration of conformity for incomplete machine	281
III.	Directive declaration of conformity with RED Directive	283
IV.	REACH declaration of conformity	284
14	Keyword index	

Thank you for your trust!

BULLS *pedelecs* are premium quality vehicles. You have made an excellent choice. Your specialist dealer will provide you with guidance and instruction and assemble your product. Your specialist dealer will also be happy to assist you in the future, whether you require an inspection, retrofit or repair.

You are receiving these operating instructions with your new pedelec. Please take time to become familiar with your new pedelec. Use the tips and suggestions in the operating instructions. They will help you to enjoy your pedelec for a long time to come. We hope you have fun and wish you well on all of your rides!

Download the operating instructions onto your phone at the following link, so that you can use them when you are out riding:



www.bulls.de/service/downloads.

Copyright

© ZEG Zweirad-Einkaufs-Genossenschaft eG

Distribution or reproduction of these operating instructions and utilisation or communication of their content is prohibited unless expressly approved. Anyone who does not comply with these restrictions is liable for compensation. All rights reserved in the event that a patent, utility model or industrial design is registered.

Subject to internal changes

The information contained in these *operating instructions* are the approved technical specifications at the time of printing. In addition to the functions described here, the software may be modified at any time to rectify errors and extend functions.

Any significant changes are included in a new published version of the operating instructions. All changes and new versions of the operating instructions are published on the following website:

www.bulls.de/service/downloads.

Editing

Text and images:
ZEG Zweirad-Einkaufs-Genossenschaft eG
Longericher Strasse 2
50739 Köln, Germany

Translation

RKT Übersetzungs- und Dokumentations-GmbH
Bahnhofstrasse 27
78713 Schramberg
Germany

If you have any questions or problems regarding these operating instructions, please contact:

tecdoc@zeg.de

1 About these operating instructions

1.1 Manufacturer

ZEG Zweirad-Einkaufs-Genossenschaft eG
Longericher Strasse 2
50739 Köln, Germany

Tel.: +49 221 17959 0
Fax: +49 221 17959 31
Email: info@zeg.de

1.2 Laws, standards and directives

The *operating instructions* comply with the essential requirements specified in:



- Machinery Directive 2006/42/EC
- Electromagnetic Compatibility Directive 2014/30/EU
- ISO 20607:2018 Safety of machinery– Operating instructions– General drafting principles
- EN 15194:2018 Cycles – Electrically power assisted cycles – pedelec bicycles
- EN 11243:2016, Cycles – Luggage carriers for bicycles – Requirements and test methods
- ISO 17100:2016-05 Translation Services – Requirements for translation services.

1.3 Language

The *original operating instructions* are written in German. A translation is invalid without the *original operating instructions*.

1.4 For your information

Different markings are used in the operating instructions to make them easier to read.

	Text for specialist dealers
	Notice on replacing components
	Notice on fitness

1.4.1 Warnings

Warnings indicate hazardous situations and actions. You will find three categories of warnings in the operating instructions:



May lead to serious or even fatal injuries if ignored. Medium-risk hazard.



May lead to minor or moderate injuries if ignored. Low-risk hazard.

Notice

May lead to material damage if ignored.

1.4.2 Markups

You will find ten text markups in the *operating instructions*:

Stylised form	Use
<i>Italics</i>	Glossary term, first mention in section
<u>Underlined in blue</u>	Link
<u>Underlined in grey</u>	Cross references
✓	Requirements
▶	Instructions for actions without specific order
1	Instructions for actions in specified order
⇒	Result of the action
SPACED	Indicators on the display screen
•	Bulleted lists
<u>Only applies to pedelecs with this equipment</u>	A note beneath the heading indicates components which can be used as an option.

Table 1: Markups

1.5 Aim of the operating instructions

These operating instructions are not a substitute for personal instruction by the specialist dealer supplying the bike. These operating instructions are an integral part of the pedelec. Therefore, if it is re-sold at a later time, they must be handed over to the subsequent owner.

These operating instructions are mainly written for people riding pedelecs.

Paragraphs with a white background are intended to enable non-professionals to make safe settings on the pedelec, use it, clean it and identify and eliminate any faults.



Sections intended for technical staff are highlighted in blue and marked with a spanner symbol.

These sections aim to allow trained technical staff (bicycle mechatronics engineers, bicycle mechanics or others) to carry out initial assembly, adjustment, inspection and repair safely.

Technical staff also need to read all sections for pedelec riders and operators to ensure they can provide better customer service.

Always fill out all reports in Section [11.1](#) and Section [11.2](#) when carrying out work.

Section		Rider	Specialist dealer
1	About these operating instructions	<input type="checkbox"/>	<input type="checkbox"/>
2	Safety	<input type="checkbox"/>	<input type="checkbox"/>
3	Description	<input type="checkbox"/>	<input type="checkbox"/>
4	Transporting and storing	<input type="checkbox"/>	<input type="checkbox"/>
5	Assembly	<input type="checkbox"/>	<input type="checkbox"/>
6	Operation	<input type="checkbox"/>	<input type="checkbox"/>
7	Cleaning, servicing and inspection	<input type="checkbox"/>	<input type="checkbox"/>
8	Inspection and maintenance	<input type="checkbox"/>	<input type="checkbox"/>
9.1	Preventing pain	<input type="checkbox"/>	<input type="checkbox"/>
9.2	Troubleshooting and fault clearance	<input type="checkbox"/>	<input type="checkbox"/>
9.3	Repair	<input type="checkbox"/>	<input type="checkbox"/>
10	Recycling and disposal	<input type="checkbox"/>	<input type="checkbox"/>
11	Documents	<input type="checkbox"/>	<input type="checkbox"/>
12	Glossary	<input type="checkbox"/>	<input type="checkbox"/>
13	Appendix	<input type="checkbox"/>	<input type="checkbox"/>
14	Stichwortverzeichnis	<input type="checkbox"/>	<input type="checkbox"/>

Table 2: Target groups-section matrix

1.6 Type number and model

These operating instructions are an integral part of pedelecs with the type numbers:

Type no.	Model	Pedelec type
22-18-1057	E-Stream EVA 1 27.5"	Mountain bike
22-18-1060	E-Stream EVA TR1 27.5"	Mountain bike
22-18-1061	E-Stream EVA TR2 27.5"	Mountain bike
22-18-1056	E-Stream EVO 1 29"	Mountain bike
22-18-2007	E-Stream EVO 1 29"	Mountain bike
22-18-1058	E-Stream EVO 2 Street 27.5"	Mountain bike
22-18-1005	E-Stream EVO AM 2 29"	Mountain bike
22-18-1004	E-Stream EVO AM 3 29"	Mountain bike
22-18-1001	E-Stream EVO AM 4 29"	Mountain bike
22-18-1005	E-Stream EVO TR1 27.5"	Mountain bike
22-15-1033	Lacuba EVO Cross	Mountain bike
22-15-1034	Lacuba EVO Cross	Mountain bike

Table 3: Type number, model and pedelec type

1.7 Frame number

Each frame has an individual frame number stamped on it (see Figure 3). The frame number can be used to associate the pedelec with the owner. The frame number is the most important identifier for verifying ownership.

1.8 Identifying the operating instructions

The operating instructions identification number is located in bottom left-hand corner of each page.

The identification number is composed of the document number, the version number and the release date.

Identification number	MY22XXX - XX_1.0_14.06.2022
------------------------------	-----------------------------

2 Safety

2.1 Residual risk

Pedelecs pose the following residual risks:

- Risk of fire and explosion
- Electric shock
- Risk of a crash
- Risk of amputation
- Malfunctions due to Bluetooth®
- Key breaking off



2.1.1 Risk of fire and explosion

Never charge if there is a critical fault

If a charger is connected to the drive system when a critical error is reported, the battery may be damaged permanently and may catch fire.

- ▶ Connect charger to fault-free electric drive system only.

Protect against penetrating water

The battery is only protected from spray water. Penetration by water can cause a short circuit. The battery may self-ignite and explode.

- ▶ Never immerse battery in water.
- ▶ Take battery out of service if you suspect water has penetrated it.

Avoid heat

Temperatures over 60 °C can also cause liquid to leak from the battery and the battery will become damaged. The battery may self-ignite and explode.

- ▶ Protect the battery against heat.
- ▶ Never store next to hot objects.
- ▶ Never expose battery to continuous direct sunlight.
- ▶ Avoid wide temperature fluctuations.

Never use incorrect charger

Chargers with excessive voltage damage batteries. This may cause a fire or an explosion.

- ▶ Only use approved batteries to charge.

Prevent short circuit due to interconnection

Metal objects may interconnect the battery's electrical terminals. The battery may self-ignite and explode.

- ▶ Never insert paper clips, screws, coins, keys and other small parts into the battery.
- ▶ Place the battery on clean surfaces only. Prevent charging socket and contacts against contamination from dirt, sand and similar.

Handling a damaged or faulty battery

Faulty batteries are hazardous goods. These include

- Cells or batteries which have been identified as faulty for safety reasons
- Leaked batteries or which have released gas
- Cells or batteries which have sustained external or physical damage
- Cells or batteries whose safety has not been tested yet

The safety electronics may fail if the batteries are damaged or faulty. The residual voltage can cause a short circuit. The battery may self-ignite and explode.

- ▶ Only use and charge the battery and accessories if they are in perfect condition.
- ▶ Never open or repair the battery.
- ▶ Batteries with external damage must be removed from service immediately.
- ▶ If a battery is dropped or struck, remove it from service and keep it under observation for at least 24 hours.
- ▶ Contact specialist dealer.

Storing faulty batteries

Your specialist dealer will dispose of faulty batteries.

- ▶ Take faulty batteries to your specialist dealer.
- ▶ Store the battery in a safety container in a dry place as per special regulations (ADR SV 376, P908) until you dispose of it.



Figure 1: Example of a safety container

- ▶ Never store near flammable substances.
- ▶ Dispose of faulty batteries in the correct manner.

Avoid overheating in the charger

The charger heats up when charging the battery. If the battery is not allowed to cool down sufficiently, it can cause a fire or burns to the hands.

- ▶ Never use charger on a highly flammable surface.
- ▶ Never cover the charger during charging.
- ▶ Never leave battery unattended during charging.

Brakes and motors

Cool down overheated brakes and motors

The brakes and the motor may become very hot during operation. There is a risk of burns or fire in case of contact.

- ▶ Never touch the brakes or the motor immediately after a ride.
- ▶ Never place the pedelec on a flammable surface, such as grass or wood, directly after use.

2.1.2 Electric shock



Never use damaged network components

Damaged chargers, cables and plug connectors increase the risk of electric shock.

- ▶ Check the charger, cable and plug connector before each use. Never use a damaged charger.

Avoid water penetrating

If water penetrates into the charger, there is a risk of electric shock.

- ▶ Use the charger indoors only.

Dealing with condensate

Condensation may form in the charger and in the battery when the temperature changes from cold to hot, causing a short circuit.

- ▶ Wait until both charger and battery are at room temperature before connecting them.

2.1.3 Risk of a crash



Set the quick release correctly

Excessively high clamping force will damage the quick release and cause it to lose its function. Insufficient clamping force will result in unfavourable transmission of force. This can cause components to break. This will cause a crash with injuries.

- ▶ Never fasten a quick release using a tool (e.g. hammer or pliers).
- ▶ Only use the clamping lever with the specified set clamping force.

Use correct torque

If a screw is fastened too tightly, it may break. If a screw is not fastened enough, it may loosen. This will cause a crash with injuries.

- ▶ Always observe the indicated tightening torque on the screw or in Section 3.5.

Use approved brakes only

The wheels are designed exclusively for use with rim brakes or disc brakes. The wheel may break if an incorrect brake is used. This will cause a crash with injuries.

- ▶ Only use the approved brakes on the wheel.

2.1.4 Risk of amputation



The brake disc in disc brakes is so sharp that it can cause serious injuries to fingers if they are inserted into the brake disc openings.

The chain wheels and belt sprockets can draw in fingers, thus causing serious injuries to fingers.

- ▶ Always keep fingers well away from rotating brake discs and the chain or belt drive.

2.1.5 Key breaking off

If you leave a key inserted when riding or transporting the pedelec, it may break off or the locking system may open accidentally.

- ▶ Pull the key from the battery lock.

2.1.6 Malfunctions due to Bluetooth®

If you use the on-board computer with Bluetooth® and/or Wi-Fi®, it may cause interference with other devices, other equipment, aircraft, and medical devices, such as pacemakers and hearing aids.

Likewise, it cannot be completely ruled out that you will cause harm to people and animals in the immediate vicinity.

- ▶ Never use the pedelec with Bluetooth® when in close proximity to medical devices, filling stations, chemical plants, areas at risk of explosion and in blasting zones.
- ▶ Never use pedelec with Bluetooth® in aircraft.
- ▶ Avoid operating for longer periods in close proximity to the body.

2.2 Toxic substances

If substances are released or used which pose a risk to people and the environment, effective protective measures must be taken.

Possible hazards, contamination and health hazards due to:

- Carcinogenic, germ-cell-mutagenic and reproduction-toxic substances
- Toxic substances
- Irritants (skin, respiratory system) and corrosive substances

What might happen?

- Serious harmful effects to health
- Threat to life
- Hazard to bystanders due to carry-over and contamination in the personal environment.



2.2.1 Carcinogenic substances

Carcinogenic hazardous substances are substances which can trigger cancer or promotes the formation of cancer. They are classified as categories 1A, 1B and 2 under European hazardous substances legislation and are labelled with the H-phrases codes H350/ H350i and H351. It is essential to carry out a professional risk assessment and select and use suitable protective measures due to the serious consequences for health and the occasionally long period of time it takes before the disease manifests itself.

Suspension oil

If you come into contact with the suspension oil in the fork, the 8pins seat post or the rear frame damper, it will irritate the respiratory tract and can cause cancer, sterility and changes to the genetic make-up of germ cells oil.

- ▶ Never dismantle the rear frame damper or the suspension fork.
- ▶ It is forbidden for pregnant women to carry out maintenance and cleaning tasks.
- ▶ Avoid skin coming into contact with suspension oil.



2.2.2 Toxic substances

Toxic substances (also known as poison or toxins) refer to substances which can cause damage to living beings if they enter the organism above a specific low dose. The more the ingested amount of a toxic substance increases, the greater the likelihood of damage to health due to poisoning is. This can lead to death.

Brake fluid

Brake fluid may leak out after an accident or due to material fatigue. Brake fluid can be fatal if swallowed or inhaled.

- ▶ Never dismantle the brake system.
- ▶ Avoid contact with skin.
- ▶ Do not inhale vapours.

Suspension oil

The suspension oil in the fork, the 8pins seat post and the rear frame damper is toxic to the touch.

- ▶ Never dismantle the rear frame damper or the suspension fork.
- ▶ It is forbidden for pregnant women to carry out maintenance and cleaning tasks.
- ▶ Avoid skin coming into contact with suspension oil.



2.2.3 Irritants and corrosive substances

Corrosive substances (also known as corrosives) destroy living tissue or attack surfaces. Corrosive substances may be in solid, liquid or gaseous form.

Irritants are hazardous substances which irritate the skin and mucous membranes once you come into contact with them. This may cause inflammation of the affected areas.

Defective battery

Liquids and vapours may leak from damaged or faulty batteries. Excessively high temperatures may also cause liquids and vapours to leak from the battery. Such liquids and vapours can irritate the airways and cause burns.

- ▶ Never dismantle the battery.
- ▶ Avoid contact with skin.
- ▶ Never inhale vapours.

2.3 Requirements for the pedelec rider

The pedelec rider must have adequate physical, motor and mental abilities to ride on public roads. A minimum age of 14 years is recommended.

2.4 Vulnerable groups

- ▶ Keep batteries and the charger away from children and people with reduced physical, sensory or mental capacities or lacking in experience and knowledge.
- ▶ Children and young people must be provided with comprehensive instructions by a legal guardian.

2.5 Personal protective equipment

- ▶ Wear a suitable helmet. The helmet must have a reflective strip or a light in a clearly visible colour.
- ▶ Wear sturdy shoes which are not too tightly laced.
- ▶ Wear padded cycling gloves.
- ▶ Wear clothing which is as bright or retroreflective as possible. Fluorescent materials are also suitable. High-visibility jackets and straps on your upper body ensure even greater safety. Never wear a skirt. Always wear trousers which reach down to your ankles instead.

2.6 Safety guards

Three safety guards on the pedelec protect pedelec riders against heat, dirt or moving parts:

- Chain or belt guards prevent clothing from being pulled into the drive train.
 - The motor cover on the motor casing protects against heat.
 - Mudguards protect against dirt and water splashing up from the road
- ▶ Never remove the guards.
 - ▶ Check the guards on a regular basis.
 - ▶ Take pedelec out of service if a guard is damaged or missing. Contact specialist dealer.

2.7 Safety markings and safety instructions

Pedelec and battery nameplates contain the following safety markings and safety instructions:



Symbol	Explanation
	General warning
	Adhere to the instructions for use

Table 4: Meaning of safety markings











Symbol	Explanation
	Read the instructions
	Separate collection of electrical and electronic devices
	Separate collection of ordinary and rechargeable batteries
	Must not be thrown into fire (burning prohibited)
	It is forbidden to open any batteries
	Device of protection class II
	Only suitable for use indoors
	Fuse (device fuse)
	EU conformity
	Recyclable material
	Protect from temperatures above 50 °C and direct sunlight

Table 5: Safety instructions

2.8 What to do in an emergency

2.8.1 Dangerous situation in road traffic

- ▶ If you encounter any hazards or dangers in road traffic, apply the brake until the pedelec comes to a halt. The brake acts as an emergency stop system in such cases.

2.8.2 Leaked brake fluid

- ▶ Remove those affected from the danger area to fresh air.
- ▶ Never leave those affected unattended.
- ▶ Remove any clothing contaminated with brake fluid immediately.
- ▶ Never inhale vapours. Ensure sufficient ventilation.
- ▶ Wear gloves and safety glasses as protective equipment.
- ▶ Keep unprotected persons away.
- ▶ Take care with leaked brake fluid as it poses a slip hazard.
- ▶ Keep leaked brake fluid away from naked flames, hot surfaces and sources of ignition.
- ▶ Avoid contact with skin and eyes.

If inhaled

- 1 Take in fresh air.
- 2 Immediately consult a doctor in case of any discomfort.

After skin contact

- 1 Wash affected skin with soap and water and rinse well.
- 2 Remove contaminated clothing.
- 3 Consult doctor in the event of pain or discomfort.

After contact with eyes

- 1 Rinse eyes under flowing water for at least ten minutes with the lids open; also rinse under lids.
- 2 Immediately consult a doctor in case of any pain or discomfort.

If swallowed

- 1 Rinse out mouth with water. Never induce vomiting. Risk of aspiration.
- 2 If a person is lying on their back and vomiting, place them in the recovery position.
- 3 Seek medical advice immediately.

Environmental protection measures

- ▶ Never allow brake fluid to flow into sewage, water courses or groundwater.
- ▶ Notify the relevant authorities if fluid penetrates the ground, water courses or the sewage system.
- ▶ Dispose of leaked brake fluid in an environmentally responsible way in accordance with statutory regulations (see Section 10.1).
- ▶ The brake system must be repaired immediately if brake fluid leaks out. Contact specialist dealer.

2.8.3 Battery vapour emission

Vapours may be emitted if the battery is damaged or used improperly. The vapours may cause respiratory tract irritation.

- 1 Get into fresh air.
- 2 Consult doctor in the event of pain or discomfort.

After contact with eyes

- 1 Carefully rinse eyes with plenty of water for at least 15 minutes. Protect unaffected eye.
- 2 Seek medical advice immediately.

After skin contact

- 1 Remove any solid particles immediately.
- 2 Remove contaminated clothing immediately.
- 3 Rinse the affected area with plenty of water for at least 15 minutes.
- 4 Then dab the affected skin gently. Do not rub dry.
- 5 Immediately consult a doctor if there is any redness, pain or discomfort.

2.8.4 Battery fire

The safety electronics may fail if the battery is damaged or faulty. The residual voltage can cause a short circuit. The battery may self-ignite and explode.

- 1 Keep your distance if the battery becomes deformed or starts to emit smoke.
 - 2 If charging, remove the plug connector from the socket.
 - 3 Contact the fire service immediately.
- ▶ Use Class fire extinguishers to put out the fire.
 - ▶ Never extinguish damaged batteries with water or allow them to come into contact with water.

Inhaling vapours can cause intoxication.

- ▶ Stand on the side of the fire where the wind is blowing from.
- ▶ Use breathing apparatus if possible.

2.8.5 Oil and lubricant leaks from the rear frame damper

- ▶ Dispose of leaked oils and lubricants in an environmentally responsible way in accordance with statutory regulations (see Section [10.1](#)).
- ▶ Contact specialist dealer.

2.8.6 Oil and lubricant leaks from the fork

- ▶ Dispose of leaked oils and lubricants in an environmentally responsible way in accordance with statutory regulations (see Section [10.1](#)).

3 Description

3.1 Proper use

All checklists and instructions for actions in these operating instructions met. Approved accessories can be installed by specialist staff.

Use the pedelec when it is in perfect, proper working order only. National requirements may apply to the pedelec which the standard equipment may not meet. Different regulations apply across the country to the riding light, reflectors and other components when riding on public roads. The general laws and the

regulations for the prevention of accidents and environmental protection in the respective country of use must be adhered to.

The rechargeable batteries are designed to supply power to the pedelec motor only. Never use the batteries for other purposes.

Each pedelec is assigned a pedelec type, which determines its proper use, function and area of use.







City and trekking bicycle	Cycle for children and young adults	Mountain bike	Racing bicycle	Cargo bike	Folding bicycle
					
<p>City and trekking bicycles are designed for comfortable, daily use and are suitable for riding on public roads.</p>	<p>Cycles for children and young adults are suitable for riding on public roads.</p> <p>Legal guardians must read the operating instructions before putting the bike into use. Tell children and young people what the operating instructions contain in a way appropriate to their age.</p> <p>Measure the height of adolescents and check the settings on the pedelec every three months for orthopaedic reasons.</p> <p>Check compliance with the maximum permitted total weight (PTW) every 3 months</p>	<p>Mountain bikes are designed for sports use. Its specific design features are tyres with a thick tread, a reinforced frame structure and a wide transmission range.</p> <p>Mountain bikes are sports bikes and not a means of transport. In addition to being physically fit, riders need time to adapt to using the pedelec. Appropriate training is required for its use. It is especially important to practice braking and riding around bends.</p> <p>The strain on hands, wrists, arms, shoulders, the neck and back is considerable. Inexperienced pedelec riders tend to brake too hard and lose control as a result.</p>	<p>Racing bikes are designed for fast rides on roads and paths with a good, undamaged road surface.</p> <p>Racing bikes are sports bikes and not a means of transport. Racing bikes are characterised by their lightweight structure and a design which is stripped to the minimum parts required for riding.</p> <p>The frame geometry and the layout of the operating elements are designed to allow the bike to be ridden at high speeds. Learning how to ride slowly, apply the brakes and get on and off the bike safely takes practice due to the frame design.</p> <p>The riding position is athletic. The strain on hands, wrists, arms, shoulders, the neck and back is considerable. The riding position requires a high level of physical fitness.</p>	<p>Cargo bikes are suitable for transporting loads on public roads on a daily basis.</p> <p>The transportation of loads requires skill and physical fitness in order to balance the additional weight. The very varied loading conditions and weight distributions require special practice and skill when braking and riding in bends.</p> <p>A longer period is required to adaptation to the length, width and turning circle. You need to be cautious when riding a cargo bike. You must pay attention to the traffic on public roads and the condition of the route accordingly.</p>	<p>Folding bicycles are suitable for riding on public roads.</p> <p>Folding bikes can be folded together and thus save space when they are transported, e.g. in cars or on local transport.</p> <p>The folding bicycle's folding design requires the use of smaller wheels and longer brake cables and Bowden cables. With increased strain, you should therefore expect a reduction in riding stability, braking power, comfort and durability.</p>

Table 6: Proper use for every type of Pedelec

3.1.1 Improper use

Failure to adhere to the proper use poses a risk of personal injury and material damage. It is prohibited to use the pedelec in the following ways:

- when the electrical drive system been manipulated
- riding with a damaged or incomplete pedelec
- riding over steps
- riding through deep water
- charging with an incorrect charger
- lending the pedelec to untrained pedelec rider
- carrying other people
- riding with excessive baggage
- riding with no hands
- riding on ice and snow
- improper servicing
- improper repair
- tough areas of use, such as professional competitions
- stunt riding or acrobatics.

City and trekking bicycle	Cycle for children and young adults	Mountain bike	Racing bicycle	Cargo bike	Folding bicycle
					
City and trekking bicycles are not sports bicycles. If used for sports, the rider can expect reduced riding stability and diminished comfort	Cycles for children and young adults are not toys.	Mountain bikes must be retrofitted with riding light, a bell and other fittings as specified by national laws and regulations before they are used on public roads.	Racing bikes must be retrofitted with riding light, a bell and other fittings as specified by national laws and regulations before they are used on public roads.	Cargo bikes are not a touring or sports bicycle.	A folding bicycle is not a touring or sports bicycle.

Table 7: Notices on improper use

3.1.2 Permitted total weight (PTW)

The pedelec may only be loaded to its maximum permitted total weight (PTW).

The maximum permitted total weight is

- the weight of the fully assembled pedelec
- plus body weight
- plus baggage

Type no.	Model	PTW [kg]
22-18-1057	E-Stream EVA 1 27.5"	130
22-18-1060	E-Stream EVA TR1 27.5"	130
22-18-1061	E-Stream EVA TR2 27.5"	130
22-18-1056	E-Stream EVO 1 29"	130
22-18-2007	E-Stream EVO 1 29"	130
22-18-1058	E-Stream EVO 2 Street 27.5"	130
22-18-1005	E-Stream EVO AM 2 29"	150
22-18-1004	E-Stream EVO AM 3 29"	150
22-18-1001	E-Stream EVO AM 4 29"	150
22-18-1005	E-Stream EVO TR1 27.5"	130
22-15-1033	Lacuba EVO Cross	150
22-15-1034	Lacuba EVO Cross	150

Table 8: Type number, model and pedelec type

3.1.3 Environmental requirements

You can be ride the pedelec within a temperature range between 5 °C and +40 °C. The electric drive system is limited in its performance outside this temperature range.

Operating temperature	5 ... +40 °C
-----------------------	--------------

During winter use, especially at temperatures below 0 °C, we recommend that you don't insert a battery charged and stored at room temperature into the pedelec until just before setting off. We recommend using thermal protection sleeves when riding longer distances at low temperatures.

As a general rule, you should avoid temperatures under -10 °C or over +40 °C.

You must also keep within the following temperature ranges:

Transportation temperature	+10 ... +40 °C
Storage temperature (recommended)	+10 ... +40 °C
Temperature Work environment	+15 ... +25 °C
Charging temperature	+10 ... +40 °C

The nameplate contains symbols for the pedelec's area of use.

- Check what tracks and roads you may ride on before setting off for the first time.











Area of use	City and trekking bicycles	Child's bicycles/ bicycles for young adults	Mountain bikes	Racing bicycle	Cargo bike	Folding bicycle
						
 1	Suitable for tarmacked and paved roads.	Suitable for tarmacked and paved roads.		Suitable for tarmacked and paved roads.	Suitable for tarmacked and paved roads.	Suitable for tarmacked and paved roads.
 2	Suitable for tarmacked roads, cycle paths and firm gravel paths and roads, and longer sections with moderate slopes and jumps up to 15 cm.	Suitable for tarmacked roads, cycle paths and firm gravel paths and roads, and longer sections with moderate slopes and jumps up to 15 cm.	Suitable for tarmacked roads, cycle paths and firm gravel paths and roads, and longer sections with moderate slopes and jumps up to 15 cm.	Suitable for tarmacked roads, cycle paths and firm gravel paths and roads, and longer sections with moderate slopes and jumps up to 15 cm.		
 3		Suitable for tarmacked roads, cycle paths and easy to demanding off-road riding, sections with moderate slopes and jumps up to 61 cm.	Suitable for tarmacked roads, cycle paths and easy to demanding off-road riding, sections with moderate slopes and jumps up to 61 cm.			
 4			Suitable for tarmacked roads, cycle paths and easy to demanding off-road riding, limited downhill use and jumps up to 122 cm.			

Table 9: Area of use

The pedelec is unsuitable for the following areas of use:











Area of use	City and trekking bicycles	Child's bicycles/ bicycles for young adults	Mountain bikes	Racing bicycle	Cargo bike	Folding bicycle
						
 1	Never drive off-road or perform jumps.	Never drive off-road or perform jumps.		Never drive off-road or perform jumps.	Never drive off-road or perform jumps.	Never drive off-road or perform jumps.
 2	Never drive off-road or perform jumps over 15 cm.	Never drive off-road or perform jumps over 15 cm.	Never drive off-road or perform jumps over 15 cm.	Never drive off-road or perform jumps over 15 cm.		
 3		Never ride downhill or perform jumps over 61 cm.	Never ride downhill or perform jumps over 61 cm.			
 4			Never traverse extremely difficult off-road terrain or perform jumps over 122 cm.			

Table 10: Unsuitable terrain

3.2 Nameplate

The nameplate is situated on the *frame*. *The exact position of the nameplate is described in Figure 3.*

The nameplate contains thirteen pieces of information.

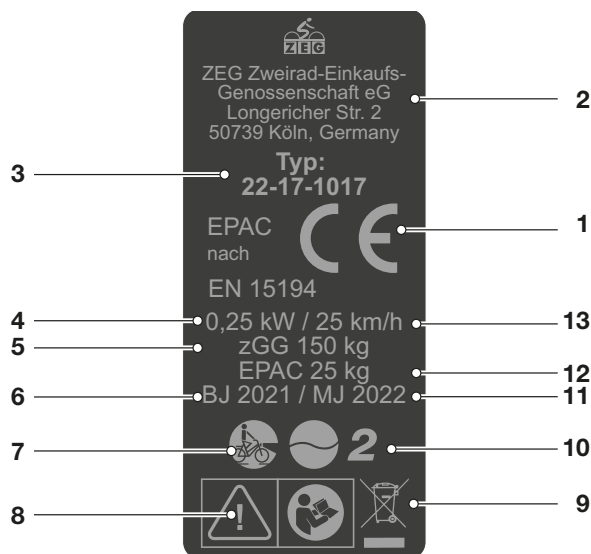

Figure 2: Example ZEG nameplate

No.	Designation	Description	More information
1	CE marking	The manufacturer uses the CE marking to declare that the pedelec complies with applicable requirements.	
2	Manufacturer's contact details	You can contact the manufacturer at the address indicated.	Section 1.1
3	Type number	All pedelec models have an eight-digit type number, which is used to specify the design model year, the type of pedelec and the version.	Section 3.2
4	Maximum continuous power rating	The maximum continuous power rating is the greatest possible power for the electric motor output shaft over 30 minutes.	
5	Maximum permitted total weight	The maximum permitted total weight is the weight of the fully assembled pedelec with the body weight plus the baggage.	
6	Year of manufacture	The year of manufacture is the year in which the pedelec was manufactured.	
7	Pedelec type	Each pedelec is assigned a pedelec type, which determines its proper use, function and area of use.	Section 3.1
8	Safety markings	Safety markings warn of hazards.	Section 2.7
9	Disposal instructions	Follow the guidelines on waste disposal when disposing of the pedelec.	Section 10.1
10	Area of use	Ride pedelec in permitted locations only.	Section 3.1.3
11	Model year	The model year refers to the first production year that the series-manufactured pedelec was produced in the version concerned. The production period is between June 2021 and June 2022. The model year is sometimes different from the year of manufacture.	
12	Weight of the ready-to-ride pedelec	The weight of the ready-to-ride pedelec is specified as a weight of 25 kg or above and refers to its weight at the time of purchase. Any extra accessories need to be added to the weight.	Section 4.1
13	Shut-off speed	The speed that the pedelec reaches at the moment when the current has dropped to zero or to the no-load current value.	

Table 11: Explanation of information on the nameplate

3.3 Components

3.3.1 Overview

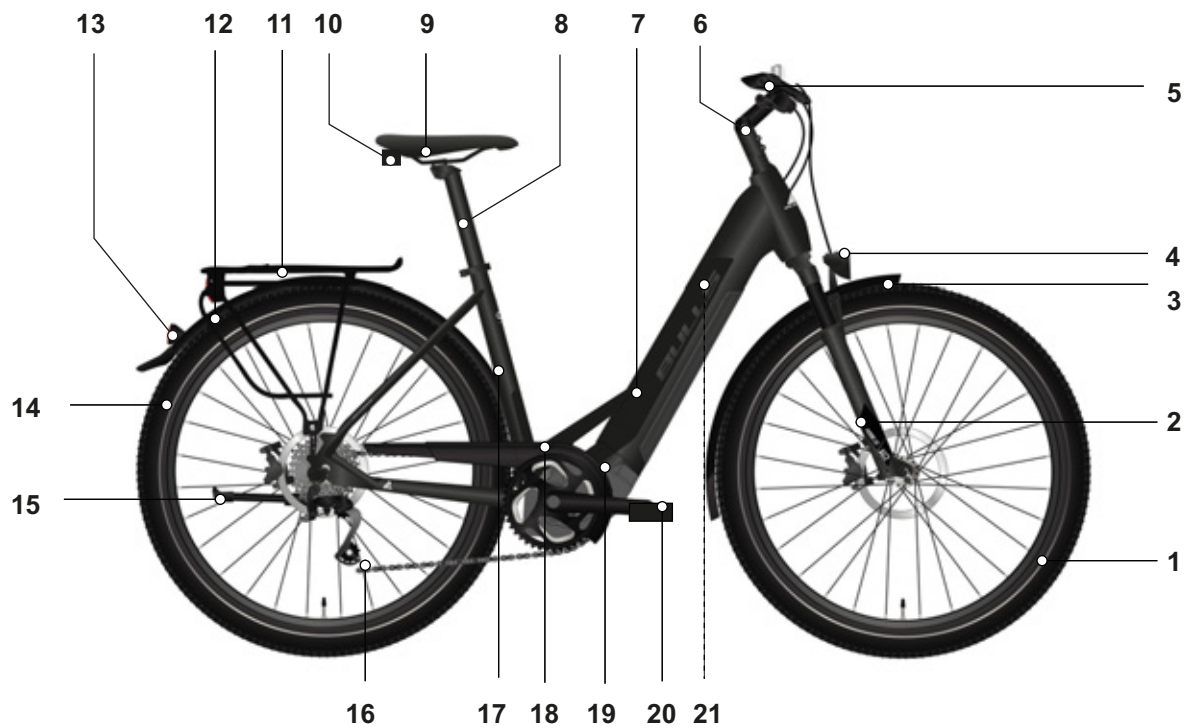

Figure 3: Pedelec viewed from right; BULLS Lacuba EVO 12 used as example

1	Front wheel	12	Rear guard
2	<u>Fork</u>	13	Rear light
3	Front guard	14	Rear wheel
4	Headlight	15	Kickstand
5	Handlebars	16	Chain
6	Stem	17	Frame number
7	Frame	18	Chain guard
8	<u>Seat post</u>	19	<u>Motor</u>
9	<u>Saddle</u>	20	Pedal
10	Reflector	21	<u>Rechargeable battery</u>
11	Pannier rack	21	<u>Nameplate</u>

3.3.2 Chassis

The chassis comprises two components:

- Frame and
- steering system

3.3.2.1 Frame

The frame absorbs all forces which act on pedelec from body weight, pedalling and the ground. The frame also acts as a carrier for most components.

The frame geometry determines the pedelec's ride performance.

3.3.2.2 Steering system

The steering system components are:

- Steering headset
- Stem,
- Handlebars
- Fork.

3.3.2.3 Steering headset

The steering headset (also known as a bike headset or simply a headset) is the fork bearing system in the frame. A distinction is made between two different types:

- Conventional steering headsets for fork steerers with thread and
- Steering headsets for threadless fork steerers, what are known as headsets.

3.3.2.4 Stem

The stem connects the handlebars to the fork steerer tube. The stem is used to adjust the handlebars to body size. The stem is used to adjust the handlebar height and the gap between the handlebars and saddle (see Section 6.5.6).

Quickly adjustable stems

Quickly adjustable stems are an extension to the fork steerer. You can change the height and angle of quickly adjustable stems without any tools. Up to 3 settings can be adjusted, depending on the model:

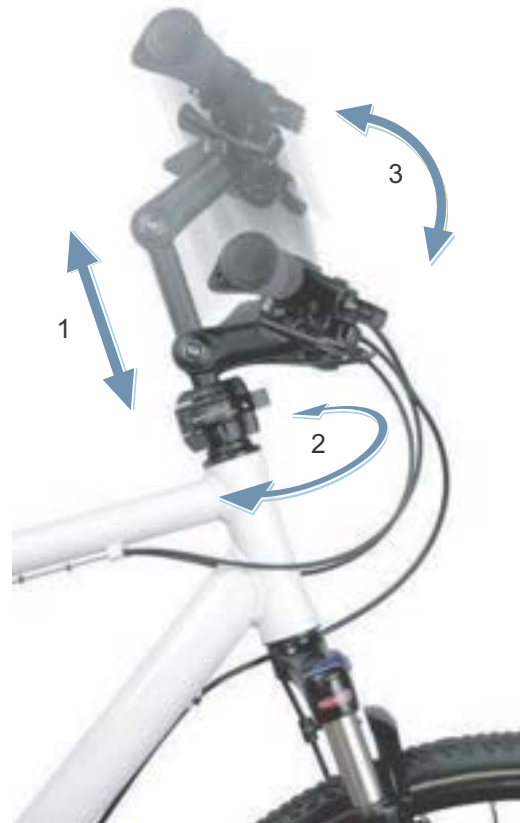

Figure 4: Example – BY.SCHULZ seat Speedlifter Twist Pro SDS

- 1 Height adjustment
- 2 Twist function
- 3 Stem angle adjustment.

Adjusting the height and stem angle increase ride comfort as different riding positions can be adopted on longer rides. The twist function saves space when parking.

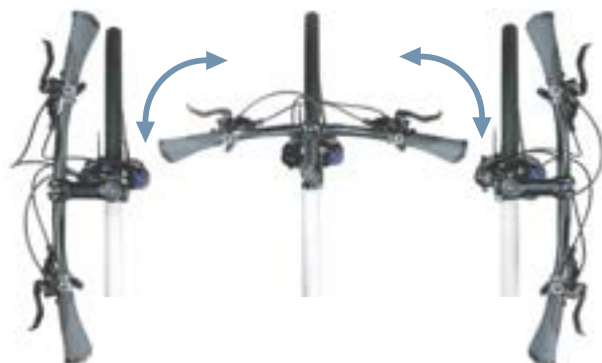

Figure 5: Twist function, using BY.SCHULZ as an example

3.3.2.5 Handlebars

The pedelec is steered using the handlebars. The handlebars are used to support the upper body and is the mount for most controls and displays (see Section 3.4.1).

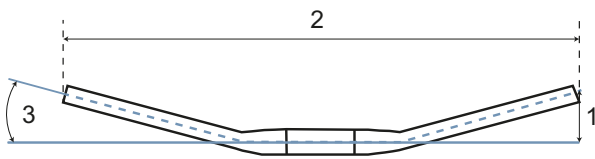

Figure 6: Handlebar dimensions

The main dimensions of handlebars are:

- 1 Rise (height)
- 2 Width
- 3 Backsweep

3.3.2.6 Fork

The stem and handlebars are attached to the top end of the fork steerer. The axle is fastened to the fork ends. The wheel is fastened to the axle.

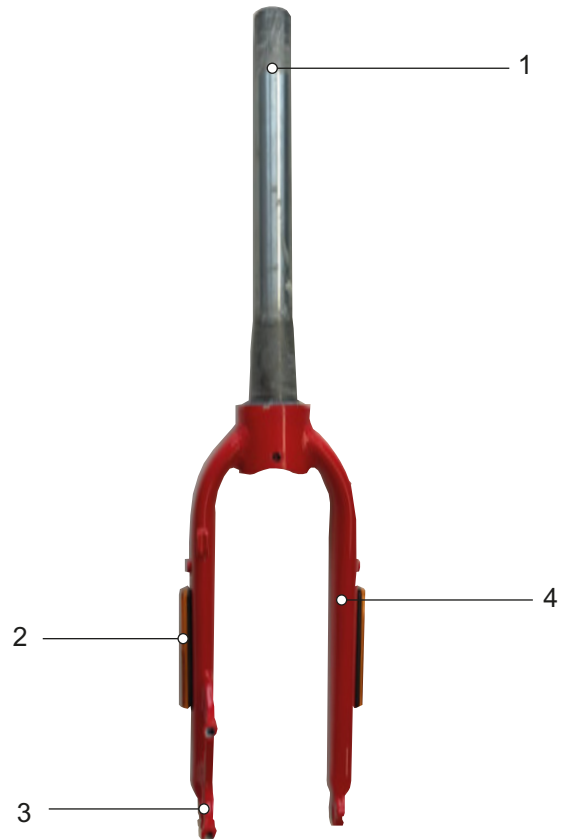

Figure 7: Overview of fork

- 1 Fork steerer
- 2 Side reflectors (optional)
- 3 Fork end
- 4 Fork leg

3.3.3 Suspension

Both forks and suspension forks are fitted in this model series.

3.3.3.1 Rigid fork

Rigid forks do not feature suspension. They transfer the used muscle and motor power to the road to optimum effect. Pedelecs with rigid forks consume less energy on steep roads and have a greater range than pedelecs with suspension.

3.3.3.2 Suspension fork

A fork deflects when a steel spring, air suspension, or both suspension types act on it.

Unlike rigid forks, suspension forks improve contact with the ground and thus enhance comfort using two functions: suspension and damping. The suspension in a pedelec prevents an impact, such as one caused by a stone lying in the pedelec's path, from being channelled directly into the body via the fork. The impact is absorbed by the suspension system instead. This causes the suspension fork to compress.

After compressing, the suspension fork returns to its original position. If the bike has a damper, the damper will slow this movement down. It thus prevents the suspension system from springing back in an uncontrolled manner and the fork from oscillating. Dampers which dampen compressive deflection movements, i.e. a compression load, are called compression dampers or compression dashpots.

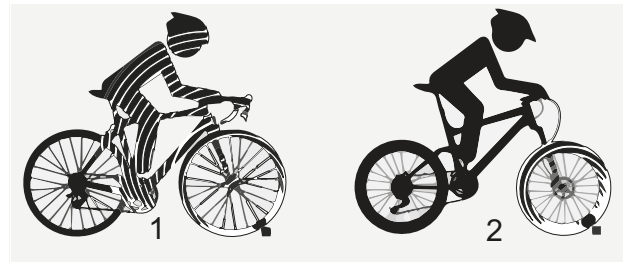

Figure 8: Without suspension (1) and with suspension (2)

Dampers which dampen rebound deflection movements, i.e. a rebound load, are called rebound dampers or dashpots.

The compression can be disabled in suspension forks. A suspension fork will then behave like a rigid fork.

The stem and the handlebars are fastened to the fork steerer. The wheel is fastened to the axle.

Negative deflection (sag)

Negative deflection (sag) is the percentage of total deflection that is compressed by body weight, including equipment (such as a backpack), the riding position and frame geometry. Sag occurs whether you are actually riding or not. The pedelec rebounds at a controlled

speed if it is optimally adjusted. The wheel stays in contact with the ground when passing over bumps (blue line). The fork head, handlebars and body follow terrain (green line) when riding over bumps. The suspension motion is predictable and controlled.

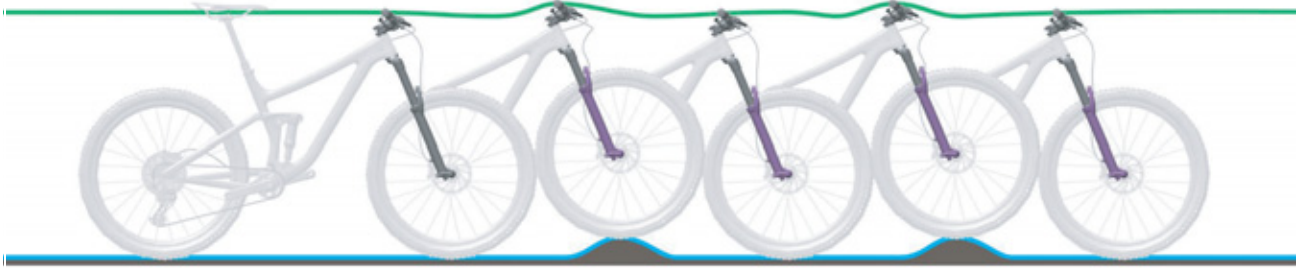

Figure 9: Optimum fork ride performance

When optimally adjusted, the fork counteracts deflection on hilly terrain and stays higher in its

deflection range. This allows the rider to maintain the same speed more easily on hilly terrain.



Figure 10: Optimum fork ride performance on hilly terrain

When optimally adjusted, the fork deflects quickly and unhindered when the bike hits bumps and absorbs a bump. Traction is retained (blue line).

The fork responds quickly to the bump. The headset and handlebars rise slightly when absorbing a bump (green line).



Figure 11: Optimum fork ride performance over bumps

Rebound damping

Rebound damping defines the speed at which the suspension rebounds after being loaded.

Rebound damping controls the suspension fork extension and rebound speed, which, in turn, has an impact on traction and control. Rebound damping can be adjusted to body weight, spring stiffness, deflection, the terrain and the pedelec rider's preferences. If the air pressure or spring stiffness increases, the extension and rebound

speeds also increase. Rebound damping needs to be increased to achieve an optimal setting if the air pressure or spring stiffness is increased. The damper rebounds at a controlled speed if the fork is optimally adjusted. The wheel stays in contact with the ground when passing over bumps (blue line). The fork head, handlebars and body follow terrain (green line) when riding over bumps. The suspension motion is predictable and controlled.



Figure 12: Optimum fork ride performance

Suspension fork compression damper

The compression damper allows the rider to make quick adjustments to the fork's suspension behaviour to adapt to changes in terrain. It is intended for adjustments made during the ride. The compression damper controls the compression lifting speed or the extent to which the fork deflects during slow impacts. The compression damper affects the absorption of bumps when weight shifts or during transitions,

cornering and uniform impacts caused by bumps and when braking. When optimally adjusted, the fork counteracts deflection on hilly terrain, stays higher in its deflection range and helps to maintain speed when riding on hilly terrain. The fork deflects quickly and unhindered and absorbs the bump when the bike hits a bump. Traction is retained (blue line).



Figure 13: Optimum ride performance on hilly terrain

Steel suspension fork structure

The stem and the handlebars are fastened to the fork steerer. The wheel is fastened to the axle.

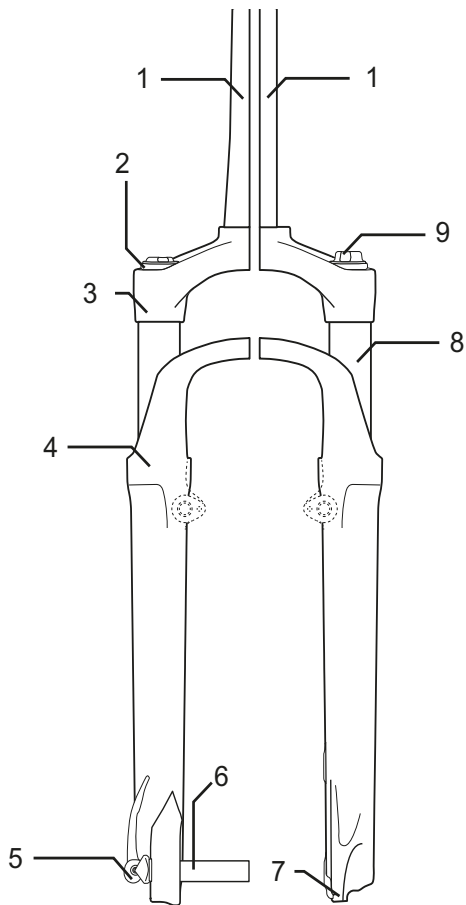

Figure 14: SR SUNTOUR steel suspension fork as an example

- | | |
|---|--------------------|
| 1 | Fork steerer |
| 2 | Sag setting wheel |
| 3 | Crown |
| 4 | Dust seal |
| 5 | Q-Loc |
| 6 | Axle |
| 7 | Fork end |
| 8 | Stanchion |
| 9 | Compression damper |

Air suspension fork structure

The air suspension fork comprises up to three assembly groups:

- Air suspension assembly (orange)
- Compression damper assembly (blue)
- At times, a rebound damper assembly (red)

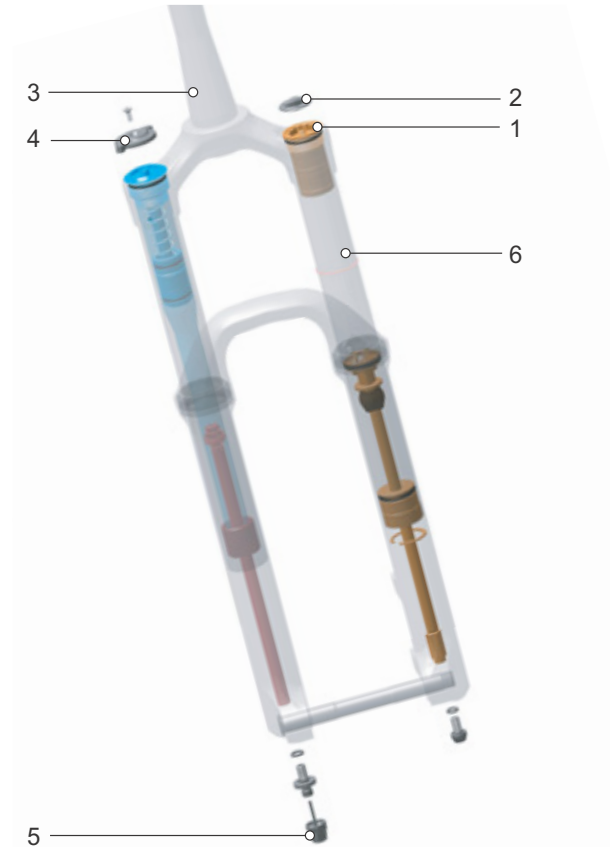

Figure 15: Internal structure of air suspension fork

- | | |
|---|-------------------|
| 1 | Air valve |
| 2 | Air valve cap |
| 3 | Fork steerer |
| 4 | Sag setting wheel |
| 5 | Rebound adjuster, |
| 6 | Stanchion |

3.3.4 Wheel

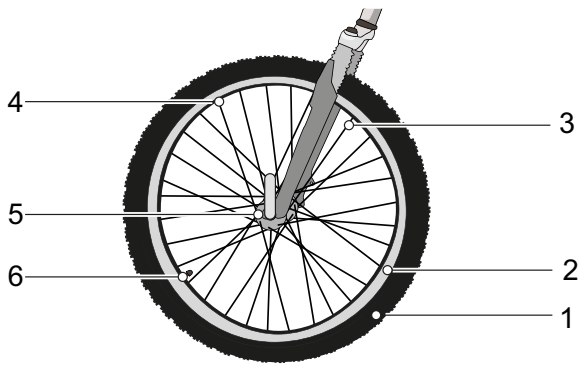

Figure 16: Visible wheel components

1	Tyres
2	Rim
3	Spoke
4	Spoke nipples
5	Hub
6	Valve

The wheel comprises a tyre, an inner tube with a valve and the wheel itself.

3.3.4.1 Tyres

The tyre forms the outer section of the wheel. The tyre is pulled onto the rim. Tyres differ in design, profile and width, depending on their intended use.



Figure 17: Example: Information on tyres

Tyre size

The tyre size pressure range is indicated on the side of the tyre.

Tyre pressure

The permitted pressure range is indicated on the side of the tyre. It is indicated in psi or bars. The tyre is only able to support the pedelec if there is adequate tyre pressure. The tyre pressure must be adjusted to the body weight and then checked on a regular basis.

Tyre design types

There are five different tyre design types:

- Tube-type tyres,
- Tubeless tyres (also tubeless ready)
- Tubular or single tube tyres
- Solid tyres
- Mixed types.

3.3.4.2 Tube-type tyre

A distinction is made between different kinds of tube-type tyre:

- Clinchers with steel wire reinforcement in bead core
- Folding tyres with aramid fibre reinforcement in bead core
- Beaded edge tyres without reinforcement in the bead core but with pronounced beads that hook under the rim edge and overlap in the rim well.



Figure 18: Structure of tube-type tyre

1	Rim (see Section 3.3.4.2)
2	Carcass
3	Puncture protection belt (optional)
4	Tread with profile
5	Bead core

Carcass

The carcass is the tyre's supporting structure. There are usually three carcass plies beneath the tread. The carcass comprises a webbing with threads, usually made of polyamide (nylon). The webbing is coated with rubber on both sides and cut at an angle of 45°. The carcass gives the tyre stability thanks to this cut at an angle to the direction of travel. The carcass plies are woven with different densities, depending on the quality of the tyres. The density of the carcass fabric is indicated by the number of threads per inch, in EPI (*ends per inch*) or TPI (*threads per inch*). There are tyres with 20 to 127 EPI carcasses.

If the EPI value is higher, the diameter of the threads used is lower. Carcass plies with a higher EPI value have threads with a smaller diameter. The higher the EPI value:

- the less rubber is needed to encase the threads,
- the lighter the tyres are
- the more flexible the tyres are and they consequently have less rolling resistance.
- The webbing is denser, so that there is greater resistance to penetration of foreign bodies. This increases puncture resistance.

In carcasses with 127 EPI, each individual thread is just 0.2 mm thick and, consequently, more vulnerable. This means that a 127 EPI tyre offers low puncture protection. 67 EPI offers the optimum compromise between weight and robustness.

Besides the webbing, the tyre's rubber compound is also important. The rubber compound comprises numerous parts:

40–60%	Natural and synthetic rubber
15–30%	Fillers, e.g. carbon black, silicic acid or silica gel
20–35%	<ul style="list-style-type: none"> • Anti-ageing agent • Vulcanisation agent, e.g. sulphur • Vulcanisation accelerator, e.g. zinc oxide • Pigments and dyes

Table 12: Rubber compound in carcasses

Tread with profile

A rubber tread is attached to the exterior of the carcass.

The tread has little influence on riding characteristics on a smooth road. The grip between the road and tyre is mainly provided by the rolling friction between the rubber and the road surface.

Slicks and road tyres

Unlike cars, a pedelec will not aquaplane. The tread contact is small and the contact pressure high. Thanks to the small contact surface on narrow and treadless tyres, the tyre interlocks with the road surface finish. Theoretically, the tyre will not aquaplane until speeds of 200 km/h are reached.

On a clean road, whether dry or wet, slick tyres will grip more effectively than treaded tyres because the contact surface is larger. The rolling resistance of slick tyres is also lower.

Off-road tyres

The tread is highly important on terrain. In this case, the tread creates an interlock with the ground, thus enabling the driving, braking and steering forces to be transmitted. The MTB tread can also help improve control on dirty roads or farm tracks.

Tread blocks on MTB tyres deform as they meet the contact surface. The energy used for this is partly converted into heat. Another part is stored and converted into the tread block's sliding movement when it leaves the contact surface, which contributes to the tyre's wear.

If a tyre with a deep tread is used on asphalt, this may make an unpleasant noise. If a pedelec with an MTB tyre is mainly ridden on the road, it is thus best to change the tyre for a pair of tyres with as little tread as possible to reduce wear and save energy. In such a case, the specialist dealer needs to replace the tyre with a new one with a shallow tread.

Bead core

Tyre carcasses are wrapped around bead cores. Wrapping the carcass around both sides creates three carcass plies.

To ensure that tyres do not slip when inflated on the rim and have an effective grip, the bead cores are stabilised in two different ways:

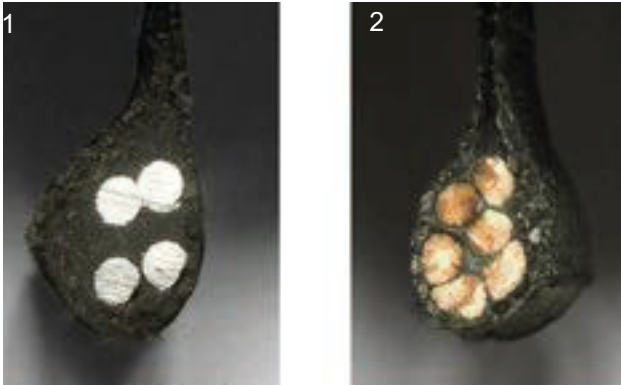

Figure 19: Steel bead core (1) and Kevlar bead core (2)

- with a steel wire. These tyres are called clinchers.
- With aramid fibres (Kevlar®). These tyres are called folding tyres. Folding tyres are about 50-90 g lighter than clinchers. It can also be folded into a smaller pack size.

Puncture protection belt

There may be a puncture protection belt between the carcass and the tread.



Figure 20: Effect of puncture protection belt

Each tyre manufacturer has its own puncture protection classes which are not on par with one another.

3.3.4.3 Rim

The rim is the metal profile on a wheel which holds the tyre, tube and rim band together. The rim is joined to the hub with spokes.

In rim brakes, the outer surface of the rim is used to brake.

3.3.4.4 Valve

Each tube-type tyre has a valve. Air is pumped into the tyre via the valve. There is a valve cap on each valve.

The screw-on valve cap keeps out dust and dirt.

The pedelec has either:

- a Dunlop valve
- a Presta valve or
- a Schrader valve.

Dunlop valve

The Dunlop valve, also known as a conventional valve, is the valve in most widespread use. The valve insert can be replaced easily and air can be let out very quickly.

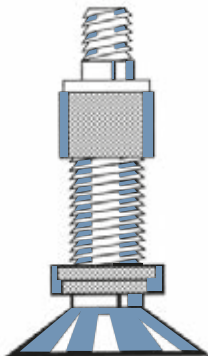

Figure 21: Dunlop valve

Presta valve

The Presta valve, also known as the Sclaverand valve or the French valve, is the narrowest variant of all valves. The Presta valve requires a smaller hole in the rim, which is why it is especially suitable for the narrow rims on racing bikes. It is about 4 to 5 g lighter than a Dunlop or Schrader valve.

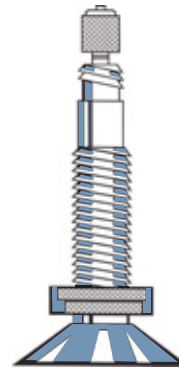

Figure 22: Presta valve

Schrader valve

The Schrader valve can be pumped at filling stations. Older, simple bicycle air pumps are unsuitable for Schrader valves.

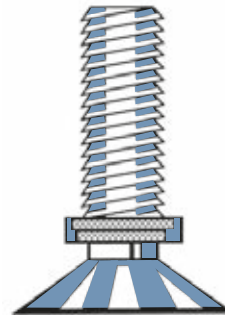

Figure 23: Schrader valve

3.3.4.5 Spoke

A spoke is a rod that connects the hub to the rim. The bent end of the spoke which is hooked into the hub is called the spoke head. A thread between 10 mm and 15 mm is attached to the other end of the spoke.

3.3.4.6 Spoke nipples

Spoke nipples are screw elements with an internal thread which fits onto the spoke thread. Fitted spokes are tensioned by tightening the spoke nipples. This straightens the wheel uniformly.

3.3.4.7 Hub

The hub is located in the centre of the wheel. The hub is connected to the rim and tyre with the spokes. An axle runs through the hub, connecting the hub with the fork at the front and with the frame at the rear.

The hub's main task is to transfer the pedelec's force of weight to the tyres. Special hubs on the rear wheel perform additional functions. There is a distinction between five types of hub:

- Hubs without additional features
- Brake hub (see back-pedal brake)
- Gear hub, also known as a hub gear
- Generator hub (for bicycles only)
- Motor hubs (for front- and rear-driven pedelecs only).

Hub without additional features

The front wheel hubs on pedelecs with central or rear motors are normally hubs without additional features.

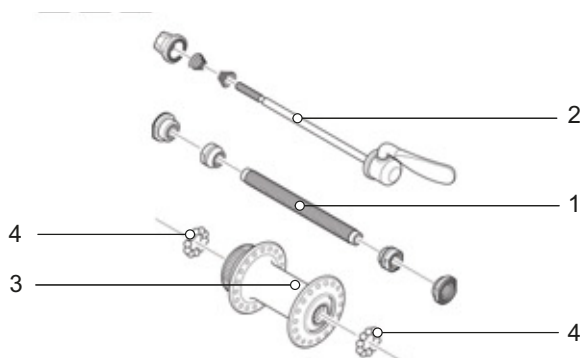

Figure 24: Example of front wheel hub: SHIMANO

- | | |
|---|---------------|
| 1 | Hub axle |
| 2 | Quick release |
| 3 | Hub body |
| 4 | Ball bearings |

3.3.5 Braking system

A pedelec's brake system is primarily operated using the brake lever on the handlebars.

- If the left brake lever is pulled, the brake on the front wheel is applied.
- If the right brake lever is pulled, the brake on the rear wheel is applied.

The brakes are used to regulate speed and make an emergency stop. Applying the brakes will bring the pedelec to a safe, rapid halt in an emergency.

The brake is applied using the brake lever either

- with the brake lever and shift cable (mechanical brake) or
- with the brake lever and hydraulic brake cable (hydraulic brake).

3.3.5.1 Mechanical brake

The brake lever is connected to the brake via a wire inside the shift cable (also known as a Bowden cable).



Figure 25: Bowden cable structure

3.3.5.2 Hydraulic brake

The brake fluid is in a closed hose system. If the brake lever is pulled, the brake fluid transfers pressure to the brake on the wheel.

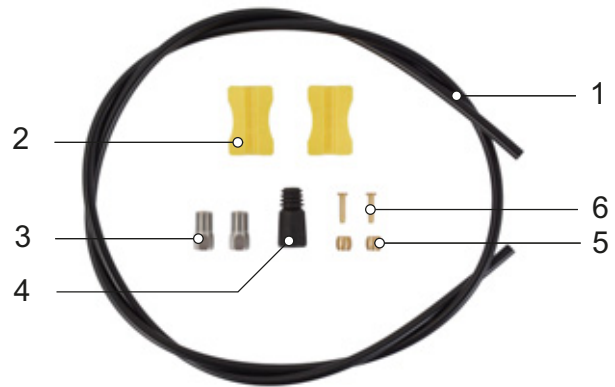

Figure 26: Components in a brake cable

- | | |
|---|-------------|
| 1 | Brake cable |
| 2 | Cable clip |
| 3 | Union nut |
| 4 | Cover cap |
| 5 | Knob |
| 6 | Insert pin |

3.3.5.3 Disc brake

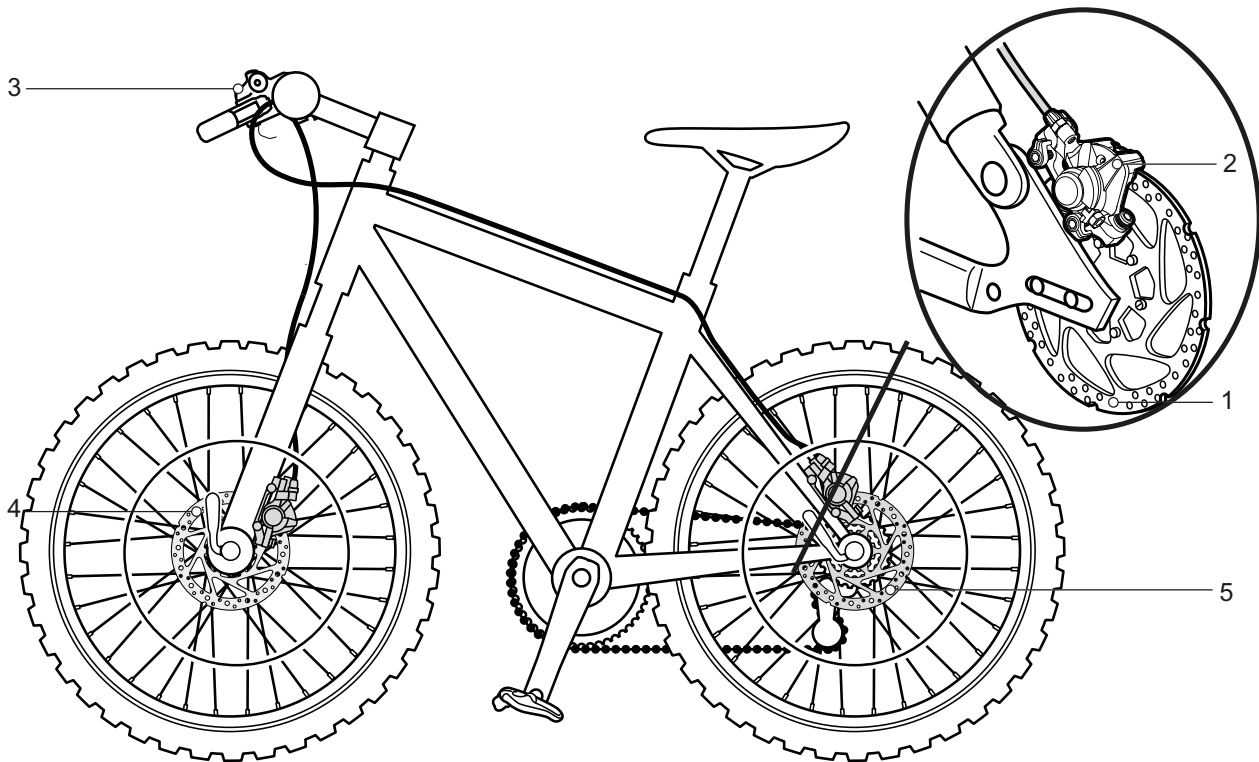

Figure 27: Brake system with disc brake – example

- 1 Brake disc
- 2 Brake calliper with brake linings
- 3 Handlebars with brake lever
- 4 Front wheel Brake disc
- 5 Rear wheel brake disc

On a pedelec with a disc brake, the brake disc is permanently screwed to the hub.

You increase brake pressure by pulling the brake lever. The brake fluid is used to transfer pressure through the brake cables to the cylinders in the brake calliper.

The braking force is boosted by a speed reduction and applied to the brake linings. These apply the brake disc mechanically. If the brake lever is pushed, the brake linings are pressed against the brake disc and the wheel movement is decelerated until it comes to a stop.

3.3.6 Saddle

The purpose of the saddle is to absorb body weight, provide support and enable different riding positions. The shape of the saddle thus depends on the intended use of the pedelec and the rider's physique and posture.

When riding a pedelec, the rider's body weight is distributed between the pedals, the saddle and the handlebars. When the rider is an upright position, the relatively small saddle area bears about 75% of the body weight. The seat area is one of the most sensitive regions of the body. The saddle should allow the rider sit free of pain and fatigue.

3.3.7 Seat post

Seat posts are not designed to fasten the saddle but also to adjust exactly to the optimum sitting position. The seat post can:

- adjust the seat height in the seat tube
- adjust the saddle horizontally with a clamping mechanism and
- adjust the saddle angle by swivelling the entire saddle clamping mechanism.

Retractable seat posts feature a remote control on the handlebars, which can be used to lower the seat post at a traffic light, for example, and then raise it again.

3.3.7.1 Patent seat post



Figure 28: Example of ergotec patent seat post with either one or two seat clamp screws

Patent seat posts have a rigid link between the saddle and the post. Patent seat posts which are angled more markedly towards the rear are offset seat posts. Offset seat posts provide a greater distance between the saddle and the handlebars.

In patent saddle posts, the saddle is attached to the head with one or two seat clamp screws. It is recommended to lubricate the thread in these screws to ensure sufficient tension when tightening the screw.

Patent saddle posts are fastened into the seat tube with either a quick release or a screwable clamp.

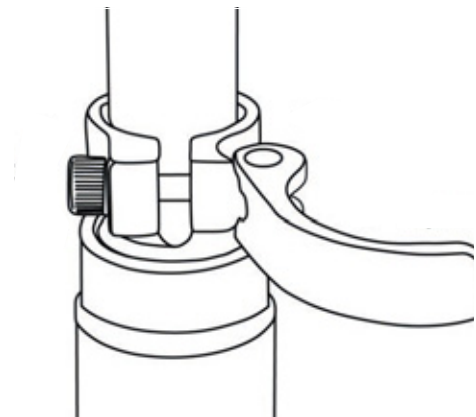

Figure 29: Example of a quick release

3.3.7.2 Suspension seat post

Suspension seat posts can reduce shock after one-time hard impacts, thus improving ride comfort significantly. However, suspension seat posts are not able to compensate for bumps in the road.

If the seat post is the only suspension element, the entire pedelec is a non-suspended mass. This has an unfavourable effect on loaded touring bikes or pedelecs with child trailers.

Suspension seat posts feature small, heavy-duty slide bearings, guides and articulated joints. If they are not lubricated on a regular basis, the sensitive response behaviour diminishes considerably, causing excessive wear.

The pre-tensioning in non-damped suspension seat posts must be adjusted in such a way that the suspension seat post does not deflect with just body weight. This prevents the suspension seat post from deflecting and bobbing intermittently at higher pedalling frequencies or if the rider pedals irregularly.

The spring stiffness can be set lower with damped suspension seat posts, thus making use of the negative deflection.

3.3.8 Mechanical drive system

The pedelec is driven by muscle power, just like a bicycle.

The force which is applied by pedalling in the direction of travel drives the front chain wheel. The chain or belt transmits the force onto the rear chain wheel and then onto the rear wheel.

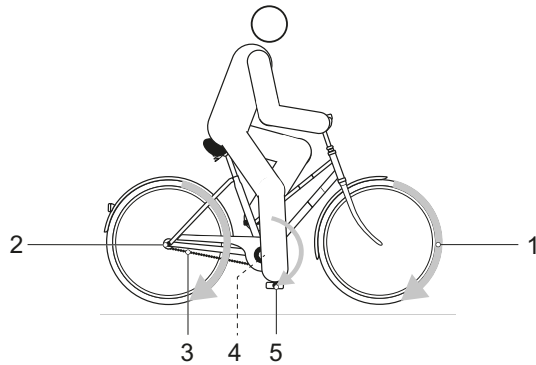

Figure 30: Diagram of mechanical drive system

- | | |
|---|----------------------------------|
| 1 | Direction of travel |
| 2 | Chain or belt |
| 3 | Rear chainring or belt pulley |
| 4 | Front chainring or belt sprocket |
| 5 | Pedal |

The pedelec is equipped with either a chain or belt drive.

3.3.8.1 Chain drive layout



Figure 31: Chain drive with derailleur gears

- | | |
|---|-----------------|
| 1 | Rear derailleur |
| 2 | Chain |

The chain drive is compatible with a

- Back-pedal brake,
- Hub gear or
- Derailleur gears.

3.3.8.2 Belt drive layout



Figure 32: Belt drive

- | | |
|---|---------------------|
| 1 | Front belt sprocket |
| 2 | Rear belt sprocket |
| 3 | Belt |

A belt drive is compatible with

- Back-pedal brake and
- Hub gear.

A belt drive is not compatible with derailleur gears.

3.3.9 Electric drive system

The pedelec has an electric drive system in addition to a mechanical one:

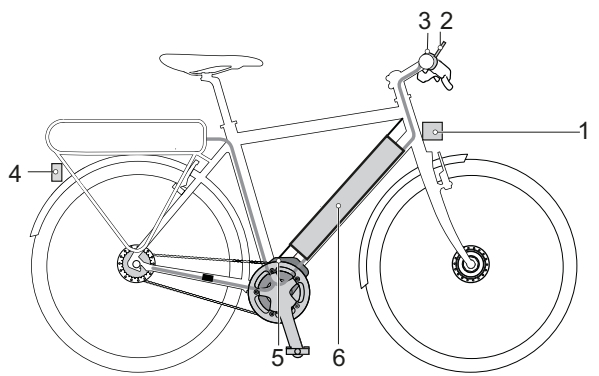

Figure 33: Diagram of electric drive system

- | | |
|---|-------------------------------------|
| 1 | Headlight |
| 2 | On-board computer |
| 3 | Rear light |
| 4 | Motor |
| 5 | Rechargeable battery |
| | A charger designed for the battery. |

3.3.9.1 Motor

As soon as the muscle power required for pedalling passes a certain level, the motor is activated gently and assists the pedalling motion. The pre-set level of assistance determines the motor output.

The motor switches off automatically as soon as pedelec riders no longer pedal, the temperature is outside the permitted range, there is an overload or the Shut-off speed of 25 km/h has been reached.

A push assist system can be switch on. The speed depends on the selected gear. The motor will continue to drive the pedelec as long as pedelec riders press the **push assist button** on the control panel. The speed can be a maximum of 6 km/h in this case. The electric drive system stops when the **push assist button** is released.

The pedelec does not have a separate emergency shut-off button. The mechanical brakes are used as an emergency stop system and bring the bicycle to a halt quickly and safely in the event of an emergency.

As soon as the muscle power required for pedalling passes a certain level, the motor is activated gently and assists the pedalling motion. The motor force is determined by the set level of assistance.

3.3.10 Rechargeable battery

The battery is located in the down tube.



Figure 34: BMZ Supercore battery

The batteries are lithium ion batteries which are developed and manufactured to the latest technical standards. The battery has an internal electronic protection circuit, which is specifically designed for the charger and the pedelec. The battery temperature is monitored at all times. Each individual cell in a battery is protected by a steel cup and cased in a plastic housing. You must not open this housing. You must also avoid mechanical loads or exposure to intense heat since they may damage the battery cells and cause flammable contents to leak out.

The battery is protected against deep discharge, overcharging, overheating and short circuit. In the event of a hazard, a protective circuit switches the battery off automatically.

The battery has a high energy content when charged. The substances in lithium-ion battery cells may become inflammable under certain conditions. You will find codes of practice for their safe handling in Section 2 Safety and Section 6.7 Rechargeable battery in the operating instructions.

If the electric drive system is not used for ten minutes (because the pedelec is stationary, for example) and no button has been pressed on the display screen or the control panel either, the electric drive system and the battery will switch off automatically to save energy. The type and duration of operating conditions have a significant effect on the battery life. Just like any other lithium-ion battery, the pedelec battery will age naturally, even if it is not being used.

The battery's service life is extended

- if it is kept at the correct storage temperature
- if it is looked after properly and
- if the battery is charged as slowly as possible.

These properties can be adjusted in the Properties. The charging capacity will decrease with age, even if the battery is maintained properly. A significantly reduced operating time after charging and a warning message on the battery indicates that the battery has reached the end of its useful life.

Battery performance is reduced when the temperature drops since this increases electrical resistance. As a result, you should expect the range to be shorter than normal in winter. We recommend using thermal protection sleeves when riding longer distances at low temperatures.

3.3.10.1 Riding light

When the riding light is turned on, the headlight and the rear light are switched on together.

3.3.10.2 Charger

There is a specific charger designed for the battery for each pedelec.

3.3.10.3 On-board computer

The pedelec features a FIT Remote on-board LCD computer which is used as a control panel and display.

The pedelec battery powers the on-board computer.

The display shows the main drive system functions and the ride data.

The on-board computer features six buttons which are used to control all the pedelec's functions.



Figure 35: FIT Remote LCD

3.4 Description of controls and screens

3.4.1 Handlebars



Figure 36: Detailed view of handlebars with FIT Remote LCD on-board computer, example

1	Handle	6	Seat post remote control
2	Rear wheel handbrake	7	Air valve
3	On-board computer	8	Lock out
4	Front wheel handbrake	9	Shifter
5	Handle		

3.4.2 On-board computer

The on-board computer is operated using six buttons.



Figure 37: Overview of control panel

- | | | | |
|---|-----------------------------------|---|--------------------|
| 1 | On-Off button (on-board computer) | 4 | Minus key |
| 2 | Selector button | 5 | Push Assist button |
| 3 | Plus key | 6 | Light button |

3.4.2.1 SELECTION MENU



Figure 38: Display (1) on the FIT Remote with LCD

Use the **selector button** (2) to switch menus.

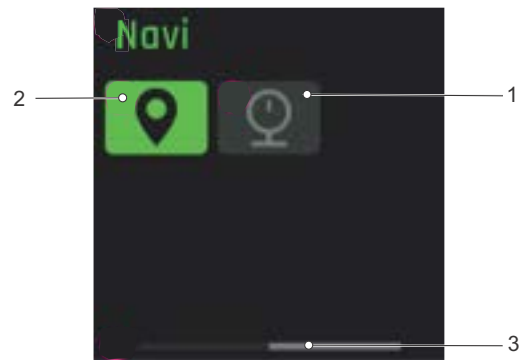

Figure 40: Selection menu, page 2

- 1 PRESSURE (see Section 3.4.2.13)
- 2 NAVI (see Section 3.4.2.12)
- 3 Guidance bar

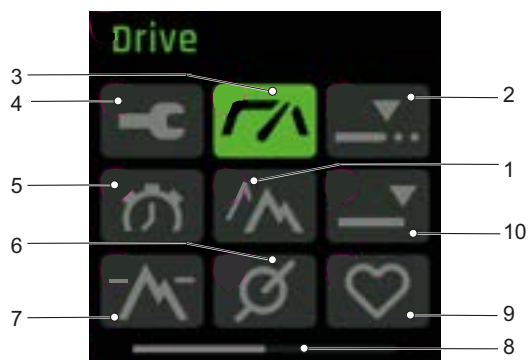

Figure 39: Selection menu, page 1

- 1 TRIP HEIGHT (see Section 3.4.2.7)
- 2 TRIP DISTANCE (see Section 3.4.2.5)
- 3 DRIVE MAIN MENU (see Section 3.4.2.2)
- 4 SETTINGS MENU (see Section 3.4.2.14)
- 5 TRIP TIME (see Section 3.4.2.6)
- 6 CADENCE (see Section 3.4.2.10)
- 7 HEIGHT (see Section 3.4.2.9)
- 8 Guidance bar
- 9 PULSE (see Section 3.4.2.11)
- 10 TOTAL (see Section 3.4.2.8)

3.4.2.2 DRIVE MAIN MENU

The DRIVE MAIN MENU screen will appear as soon as the display is switched on.

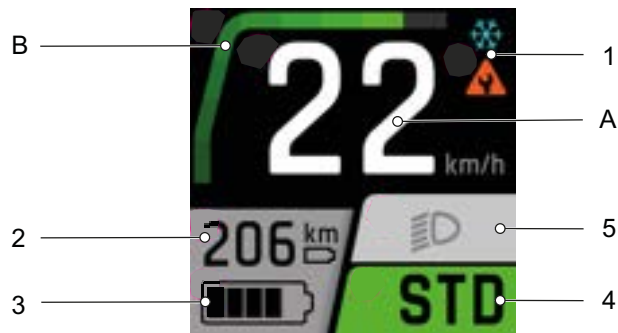

Figure 41: Drive main menu screen

The DRIVE MAIN MENU SCREEN has six indicator elements, which are the same for all screens.

- 1 Warnings indicator
- 2 Range indicator
- 3 Battery level indicator screen
- 4 Level of assistance indicator
- 5 Riding light symbol indicator

The indicator elements in the centre (A and B) change on each different screen.

- A Current speed indicator
- B Motor power indicator

1. Warnings indicator

A warning symbol is displayed here if there is an error, fault or hazard. See Section 6.2 System messages for more information.

2. Range indicator

The Range indicator shows the potential trip distance that can be covered with the current battery level and ride mode.

3. Battery Level indicator screen

The **Battery Level indicator** can be read on the display screen and on the battery LEDs.

4. Level of assistance indicator

The higher the selected level of assistance, the more the electric drive system assists the rider when pedalling.







Level of assistance	Use
	The HIGH level of assistance offers maximum motor assistance. For comfortable riding using little force. Also suitable for high pedalling frequencies, e.g. on roads.
	The STD level of assistance provides medium motor assistance. Suitable for sports riding on urban roads.
	The ECO offers low motor assistance for maximum efficiency. Pedelec riders need to pedal the most forcibly in the ECO assistance level.
	In the AUTO level of assistance, the system automatically selects the right assistance for the ride situation concerned.
	In the OFF level of assistance, the motor assistance is switched off when the electric drive system is switched on. Riders can use the pedals on the pedelec like a normal bicycle. All screen settings and the light still function as normal.
	In the BOOST level of assistance, the motor power is increased to HIGH irrespective of the selected level of assistance. This function is only available in ride mode.

Table 13: Overview of level of assistance

5. Riding Light Symbol indicator

The following riding light symbols can be shown:



	Dimmed headlight (only applies to pedelecs with this equipment)
	Main beam (only applies to pedelecs with this equipment)
	Light off

Table 14: Overview of riding light symbols

A. Current Speed indicator

The unit of speed is displayed in km/h or mph.

B. Motor Power indicator

The motor power used is displayed as a bar. The maximum motor power depends on the selected level of assistance.

3.4.2.3 DRIVE SUB-MENU 1

The indicator elements in the DRIVE SUB-MENU 1 are the same as those in the XXXDRIVE MAIN MENU.



Figure 42: Drive sub-menu screen, page 1

- C Clock indicator
- D Connection Status indicator

C. Clock indicator

The time is displayed in either 12-hour or 24-hour format.

D. Connection Status indicator

The Connection Status indicator displays all auxiliary devices which are connected to the display screen.

- ✓ Connected devices display a green icon;
- ✓ Non-connected devices display a grey icon.

3.4.2.4 DRIVE SUB-MENU 2

The indicator elements in the DRIVE SUB-MENU 2 are the same as those in the XXXDRIVE MAIN MENU.

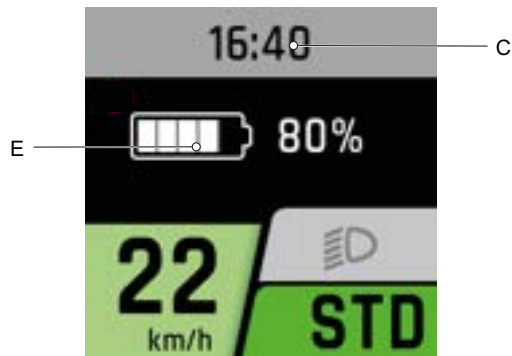

Figure 43: Drive sub-menu screen, page 2

- C Clock indicator
- E Battery level indicator screen

C Clock indicator

The time is displayed in either 12-hour or 24-hour format.

E Battery Level indicator

The **Battery Level indicator** can be read on the display screen and on the battery LEDs.

3.4.2.5 TRIP DISTANCE

The indicator elements in TRIP are the same as those in the XXXDRIVE MAIN MENU.

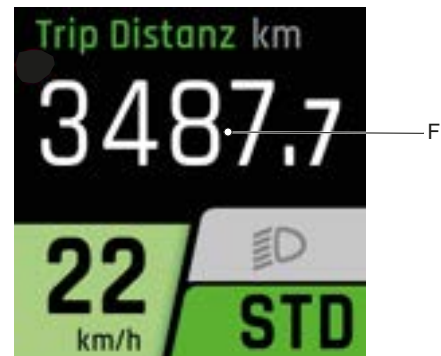

Figure 44: Trip Distance screen

- F Trip Distance indicator

F Trip Distance indicator

The Trip indicator displays the number of kilometres travelled since the last reset.

3.4.2.6 TRIP TIME

The indicator elements IN TRIP TIME are the same as those in the XXXDRIVE MAIN MENU.

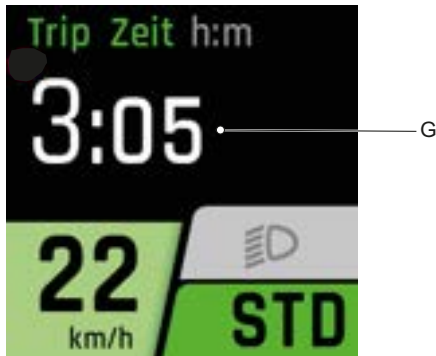

Figure 45: Trip Time screen

G Trip Time indicator

G Trip Time indicator

The Time indicator displays the riding time since the last reset.

3.4.2.7 TRIP HEIGHT

The indicator elements IN TRIP HEIGHT are the same as those in the XXXDRIVE MAIN MENU.

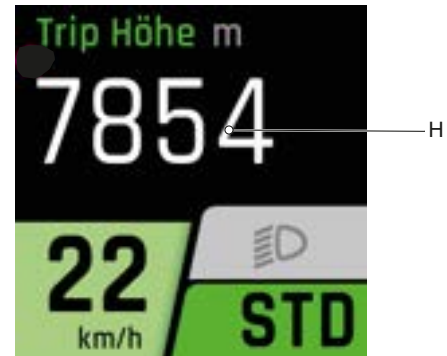

Figure 46: Trip Height screen

H Trip Height indicator

H Trip Height indicator

The Trip Height indicator displays the difference in altitude ridden since the last reset.

3.4.2.8 TOTAL

The indicator elements in GESAMT are the same as those in the DRIVE MAIN MENU.

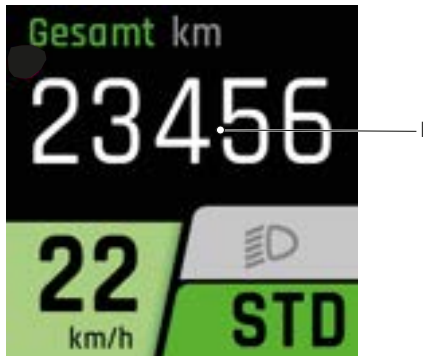

Figure 47: Total screen

I Total indicator

I Overall indicator

The Total indicator displays the overall distance that the pedelec has travelled on the odometer. This value cannot be reset.

3.4.2.9 CURRENT ALTITUDE

The indicator elements IN CURRENT HEIGHT are the same as those in the XXXDRIVE MAIN MENU.

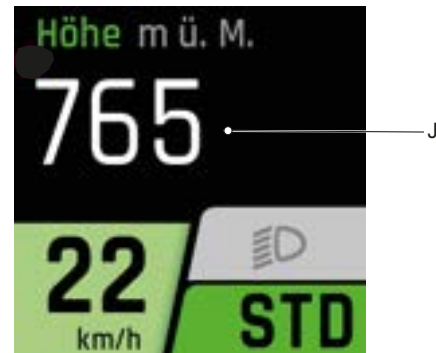

Figure 48: Altitude screen

J Current Altitude indicator

J Current Altitude indicator

The Current Altitude indicator displays the altitude above sea level.

3.4.2.10 CADENCE

The indicator elements in KADENZ are the same as those in the DRIVE MAIN MENU.

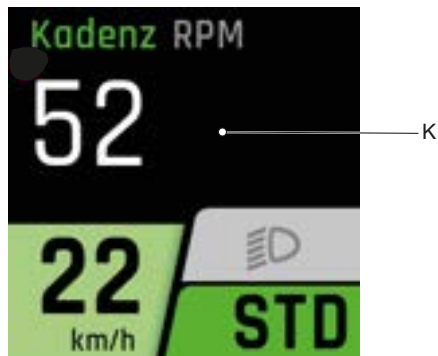

Figure 49: Cadence screen

K Cadence indicator

K Cadence indicator

The Cadence indicator displays the current number of revolutions while pedalling.

3.4.2.11 PULSE

The indicator elements in PULSE are the same as those in the DRIVE MAIN MENU.

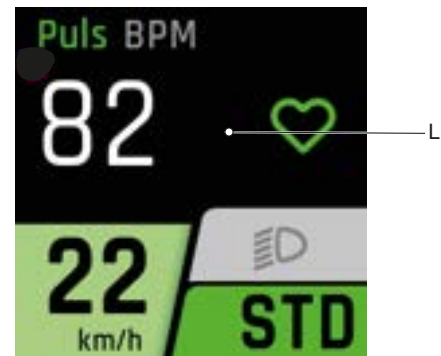

Figure 50: Pulse screen

L Pulse indicator

L Pulse

This reading is only available in conjunction with a heart rate monitor. The Pulse indicator displays the measured pulse if there is a heart rate sensor.

3.4.2.12 NAVI

The indicator elements in NAVI are the same as those in the DRIVE MAIN MENU.



Figure 51: Overview of NAVI

M Navi indicator

M Navi indicator

A satnav can be used here.

More information at:

<https://fit-ebike.com/en-en/technology/fit-e-bike-control-app/>

3.4.2.13 PRESSURE

The indicator elements in PRESSURE are the same as those in the XXXDRIVE MAIN MENU.



Figure 52: Overview of DRUCK

N Tyre Pressure (rear) indicator
O Tyre Pressure (front) indicator

N and O Tyre Pressure indicator

These readings are only available in conjunction with tyre pressure sensor. The tyre pressure indicator displays the current tyre pressure reading in bar.

3.4.2.14 SETTINGS MENU

All system and service-relevant values can be read and changed in the settings. The settings menu structure is customised and may change when components or services are added.

The settings menu can only be opened when stationary.

Menu	Submenu
Resetting the values	
	→ <Trip Reset>
	→ <Factory settings>
Default settings	
	→ <Language>
	→ <Time>
	→ <Date>
	→ <Units>
	→ <Time Format>
Connectivity	
	→ <Connect Heart Rate Sensor>
My Bike	
	→ <Assistance>
	→ <Calibration Altitude>
	→ <Auto Backlight>
	→ <Auto Power Off>
	→ <Vibration Feedback>
Charging	
	→ <Normal Charge>
	→ <Fast Charge>
	→ <Charge to Storage>
	→ <LONG-LIFE mode>
Errors	
About	

Table 15: Basic structure of FIT menu and sub-menu

– Resetting the values

→ <Trip Reset>

All values in the TOUR MAIN MENU and SUB-MENU will be reset:

- Trip
- Time
- Trip height,
- Cons.,
- MAX
- AVG

→ <Factory Reset>

Reset the system to its condition on delivery. All user data will be lost during reset.

– Default settings

→ <Language>

Sets the language.

→ <Time>

Sets the clock.

→ <Date>

Sets the date.

→ <Units>

The unit can be selected from the following variables:

Variable	Metric	Imperial
Distance	km	mi
Speed	km/h	mph
Energy consumption	Wh/km	Wh/mi
Temperature	°C	°F
Altitude above sea level	MSL M.	ASL

Table 16: Units

→ <Time Format>

Display time in either 12-hour or 24-hour format.

– Connectivity

→ <Connect Heart Rate Sensor>

– My Bike

→ <Assistance>

Adapt assistance to needs. The motor output at the ECO, STANDARD and AUTO levels of assistance can set at the same time. If all bars on the screen are black, the maximum possible assistance is configured in the three levels of assistance. This setting means a shorter range. If only the bar on the far left of the screen is black, minimum assistance is configured in the three levels of assistance. This setting allows the maximum possible range in the ECO assistance mode.

→ <Calibration Altitude>

Calibrates the altimeter. Altitude measurement depends on the air pressure and deviations may arise if the air pressure fluctuates.

→ <Auto Backlight>

This allows you to select between the display screen backlight adjusted to the ambient light or adjusted manually. The backlight brightness can be adjusted.

→ <Auto Power Off>

This sets the time after which the electric drive system will switch off automatically if it is not used.

→ <Vibration feedback>

Adjusting vibration feedback for the control panel:

Selection	Description
OFF	No vibration feedback
ON	Each press of a button and every active message produces vibration feedback
Only with messages	Vibration feedback is only produced for messages

Table 17: Vibration Feedback

– Charging

This sets the desired charge mode.

Selection	Description
Normal	Normal charging
Fast	Fast charging
Charge to Storage	The battery is charged for a longer storage period
LONG LIFE	Less battery capacity is available but the battery life is considerably longer.

Table 18: Charge mode

– Information

This gives access to the list of current error messages.

– About

This gives access to the software version of the individual components.

3.4.2.15 Error message

The electric drive system monitors itself continuously and displays a number as an error message (also called a system message) if a known error is detected. The system may switch off automatically depending on the type of error.

There is a table of system messages in Section 6.3.

You will find assistance for errors in Section 9.

3.4.3 SHIMANO gear shift

There is either a switch control panel or a shifter on the right side of the handlebars. There can be three different switches, depending on the model:

- 3-switch control panel
- 2-switch control panel or
- MTB control panel.

3.4.3.1 3-switch switch control panel

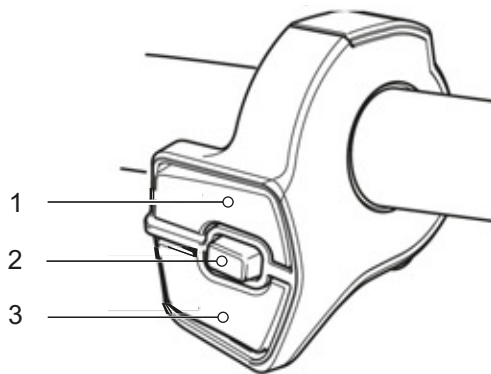

Figure 53: Overview of 3-switch control panel

- 1 Switch X
- 2 Switch A
- 3 Switch Y

3.4.3.2 2-switch switch control panel

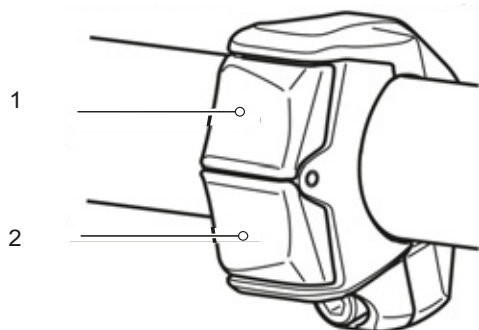

Figure 54: 2-switch control panel

- 1 Switch X
- 2 Switch Y

3.4.3.3 MTB switch control panel

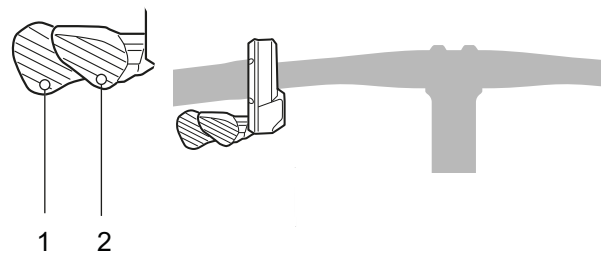

Figure 55: MTB control panel

- 1 Switch Y
- 2 Switch X

3.4.3.4 Switch control panel functions on right

Switch	Function
X	Change up
Y	Change down
A	Switching between automatic and manual gear shift

If there is no switch A on the switch control panel, the button on the on-board computer will control these functions.

3.4.3.5 Shifter SL-M5100

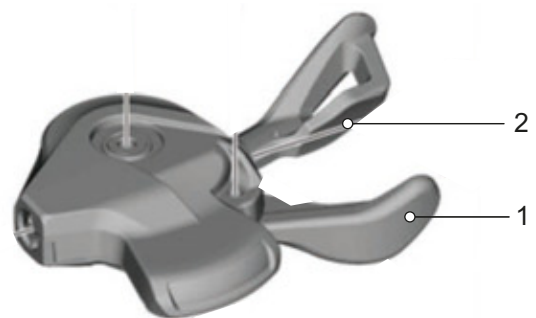

Figure 56: Shifter SL-M5100

- 1 Shifter A
- 2 Shifter B

3.4.3.6 Shifter SL-M8100

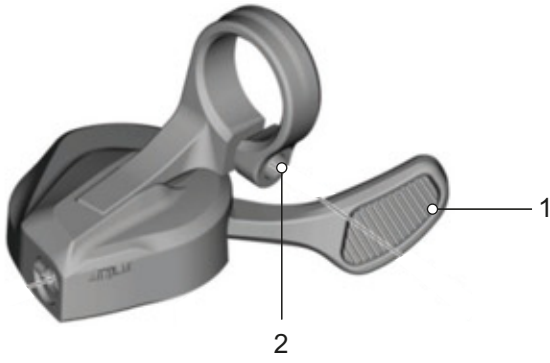

Figure 57: Shifter SL-M8100

- 1 Shifter
- 2 Attachment screw for shifter

3.4.4 Handbrake

There is a handbrake on the left and right of the handlebars.

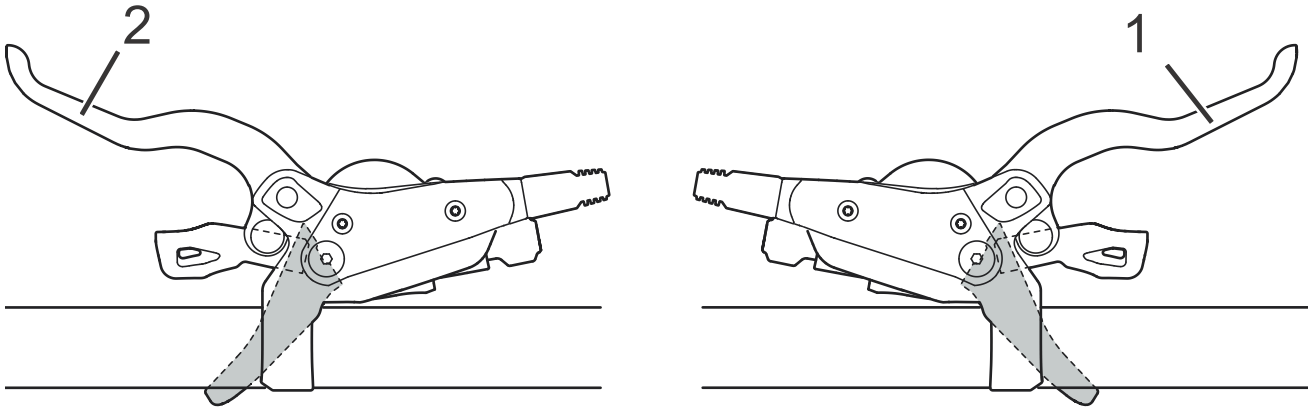

Figure 58: Front wheel (2) and rear (1) brake levers – Shimano brake used as an example

The left handbrake (2) controls the front wheel brake.

The right handbrake (1) controls the rear wheel brake.

3.4.5 Fork lock

Only applies to vehicles with this equipment

The suspension in suspension forks is adjusted using fork locks. The fork locks are either directly on the suspension fork or can be controlled using the remote control on the handlebars.

3.4.5.1 SR Suntour

The following (compression dampers) may be featured on the suspension fork:

Suspension fork	RL	RL-R	LO	LO-R	HLO
	Lockout with remote control	Lockout with remote control + rebound adjustment	Lockout on the fork	Rebound adjustment + lockout on the fork	Hydraulic lockout
					
Axon		x		x	
CR			x		x
M3010					
MOBIE25		x		x	
NCX	x		x		
NEX	x		x		x
NVX	x				x
XCE					
XCM	x		x	x	
XCR	x	x	x	x	
XCT					x

Table 19: Fork lock by suspension fork

3.4.6 Indicators on the battery

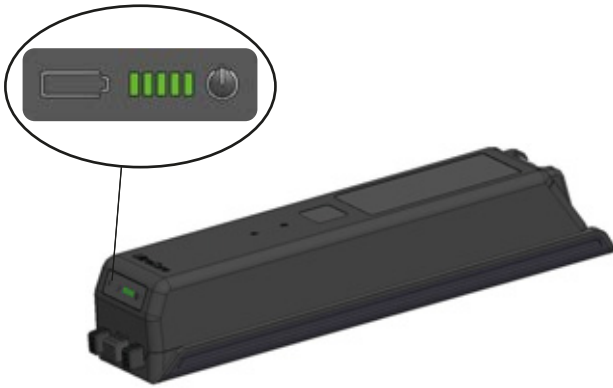

Figure 59: Battery Level indicator position

The battery level indicator is on the battery:

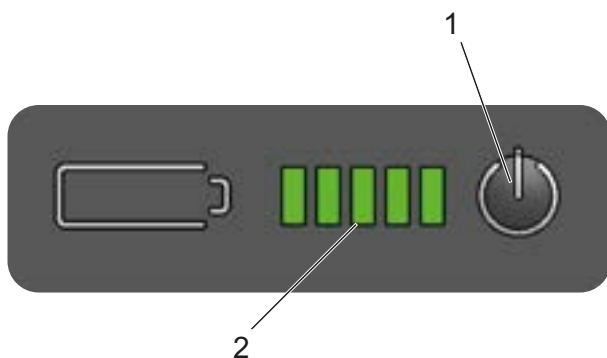

Figure 60: Overview of battery indicator display

- 1 On-Off button (battery)
- 2 Battery Level indicator screen

3.4.6.1 Battery Level indicator screen

The five green LEDs on the **battery level indicator** show the charge level when the battery is switched on. Each LED represents 20% of the battery level. The charge level for the activated battery is also shown on the *display screen*.

If the battery level falls below 5%, all the LEDs on the battery level indicator will go out. However, the battery level is still shown on the *display screen*.

The five LEDs on **battery level indicator** show the charge level when the battery is switched on. Each LED represents 20% of the battery level.

● ● ● ● ●	100... 80%
● ● ● ● ○	79... 60%
● ● ● ○ ○	59... 40%
● ● ○ ○ ○	39... 20%
● ○ ○ ○ ○	19... 5%
○ ○ ○ ○ ○	4... 0%

Table 20: Battery level indicator when discharging

● ○ ○ ○ ○	0... 19%
● ● ○ ○ ○	20... 49%
● ● ● ○ ○	40... 69%
● ● ● ● ○	60... 79%
● ● ● ● ●	80... 99%
● ● ● ● ●	100%

Table 21: Battery level indicator when charging

Symbols

● LED on	○ LED off	★ LED flashing
----------	-----------	----------------

The charge level for the activated battery is also shown on the *display screen*. If the battery level falls below 4%, all the LEDs on the battery level indicator will go out. However, the battery level is still shown on the *display screen*.

System errors and warnings are displayed by various light patterns on the **battery level indicator**. There is a table with all system messages in Section 6.2 System messages.

3.5 Technical data

3.5.1 Pedelec

Transportation temperature	+5 °C... +25 °C
Ideal transportation temperature	+10 °C... +15 °C
Storage temperature	+10 °C... +30 °C
Ideal storage temperature	+10 °C... +5 °C
Operating temperature	+5 °C... +35 °C
Temperature Work environment	+15 °C... +25 °C
Charging temperature	0 °C... +40 °C
Power output/system	250 W (0.25 kW)
Shut-off speed	25 km/h

Table 22: Technical data for pedelec without battery

3.5.2 BROSE Drive S- Mag Pro motor

Max. torque	90 Nm
Nominal voltage	36 V
Continuous power rating	250 W
Weight about	2.9 kg
Operating and storage temperature	-25 °C... +80 °C
Dimensions (L × W × H)	204 × 150 × 115 mm
Protection class	IP 56

Table 23: Technical data for BROSE Drive S-Mag Pro motor

3.5.3 BROSE Drive S-Mag Plus motor

Max. torque	85 Nm
Nominal voltage	36 V
Continuous power rating	250 W
Weight about	2.9 kg
Operating and storage temperature	-25 °C... +80 °C
Dimensions (L × W × H)	204 × 150 × 115 mm
Protection class	IP 56

Table 24: Technical data for BROSE Drive S-Mag Plus motor

3.5.4 FIT Remote LCD on-board computer

Operating temperature	-5 ... +40 °C
Storage temperature	-10 ... +40 °C
Protection class (with USB cover closed)	IPx7
Weight about	0.1 kg

Table 25: Technical data for FIT Remote LCD on-board computer

3.5.5 Emissions

The safety requirements as per Electromagnetic Compatibility Directive 2014/30/EU have been met. The pedelec and the charger can be used in residential areas without restriction.

A-weighted emission sound pressure level	< 70 dB(A)
Total vibration level for the hands and arms	< 2.5 m/s ²
Highest effective value of weighted acceleration for the entire body	< 0.5 m/s ²

Table 26: Emissions

3.5.6 Rechargeable battery

3.5.6.1 UltraCore FIT 555 Wh

Nominal capacity	14.55 Ah
Energy	555 Wh
Weight	3.3 kg
Voltage	36.9 V
Dimensions (L × W × H)	385 × 95 × 75 mm
Discharging temperature	-20 ... +55 °C
Charging temperature	0 ... +45 °C
Storage temperature	10 ... +25 °C

Table 27: Technical data for BMZ UltraCore FIT 555 Wh battery

3.5.6.2 UltraCore FIT 740 Wh

Nominal capacity	19.8 Ah
Energy	740 Wh
Weight	3.7 kg
Voltage	36.9 V
Dimensions (L × W × H)	385 × 95 × 75 mm
Discharging temperature	-20 ... +55 °C
Charging temperature	0 ... +45 °C
Storage temperature	10 ... +25 °C

Table 28: Technical data for BMZ UltraCore FIT 740 Wh battery

3.5.6.3 UltraCore FIT 925 Wh

Nominal capacity	24.2 Ah
Energy	925 Wh
Weight	4.5 kg
Voltage	36.9 V
Dimensions (L × W × H)	385 × 95 × 95 mm
Discharging temperature	-20 ... +55 °C
Charging temperature	0 ... +45 °C
Storage temperature	10 ... +25 °C

Table 29: Technical data for BMZ UltraCore FIT 925 Wh battery

3.5.7 Saddle width

3.5.7.1 BROOKS ENGLAND

Riding position	
<p>Narrow saddle</p> <p>Sharply inclined upper body, back at an angle of 30°...60°.</p>	<p>Position on trekking bike</p> 
<p>Medium-width saddle</p> <p>Slightly inclined upper body, back at an angle of 60°...70°.</p>	<p>Position on city bike</p> 
<p>Wide saddle</p> <p>Upright, almost vertical posture, back at an angle of almost 90°.</p>	<p>Position on roadster</p> 

Table 30: BROOKS ENGLAND Specifications

3.5.7.2 ERGON

Suitable sit bone distance	
Medium/position	12 - 16 cm
Small/medium	9 - 12 cm

Table 31: ERGON Specifications

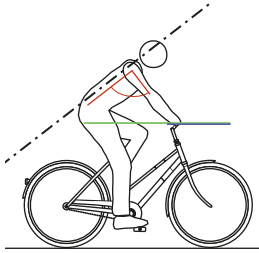
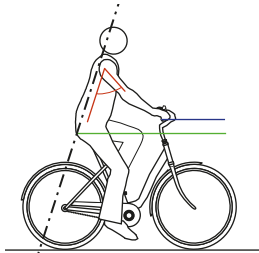
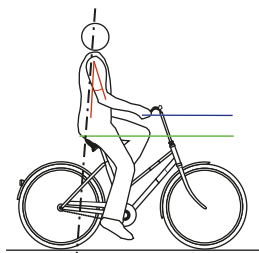
3.5.7.3 SELLE ROYAL

Riding position	
<p>Athletic</p> <p>Sharply inclined upper body, back at an angle of 30°...60°.</p>	<p>Position on trekking bike</p> 
<p>Moderate</p> <p>Slightly inclined upper body, back at an angle of 60°...70°.</p>	<p>Position on city bike</p> 
<p>Relaxed</p> <p>Upright, almost vertical posture, back at an angle of almost 90°.</p>	<p>Position on roadster</p> 
Suitable sit bone distance	
Small	<11 cm
Medium	11 - 13 cm
Position	>13 cm

Table 32: SELLE ROYAL Specifications

3.5.8 Puncture protection level

3.5.8.1 SCHWALBE



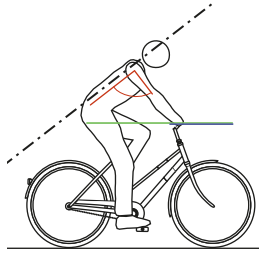
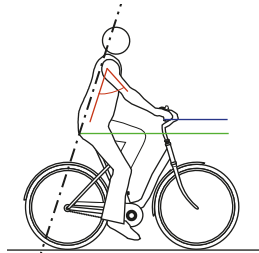
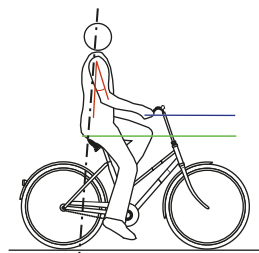





PPI	Rubber insert	Inserts Combination	Webbing insert
7	SmartGuard®		
6		DualGuard Double Defense®	Tubeless Easy
5	GreenGuard® PunctureGuard		V-Guard
4			RaceGuard®
3	K-Guard		
2			Performance LiteSkin
1			

Figure 61: Classification of puncture protection belts according to puncture protection level (PPL)

	<p>SmartGuard® SmartGuard® comprises a protective belt made of highly elastic special rubber 5 mm thick, which is partly obtained from recycled material.</p>
	<p>DualGuard DualGuard puncture protection technology consists of two layers of special rubber and nylon webbing 2.5 mm thick beneath the tread.</p>
	<p>Double Defense® This combined puncture protection is available in three versions:</p> <ul style="list-style-type: none"> • In the race version, protection is provided by SnakeSkin (all round) and RaceGuard (beneath the tread). • In tour tyres, SnakeSkin takes affect on the side walls while the high-density is attached beneath the tread. • <i>Plus</i> tyres combine one layer of GreenGuard beneath the tread and SnakeSkin on the side walls.
	<p>Tubeless Easy The Tubeless technology, special monofile webbing (SnakeSkin or MicroSkin) prevent air loss and guarantee puncture protection in combination with sealant.</p>

	<p>V-GUARD The V-Guard puncture protection belt comprises of lightweight, cut-resistant fibres. Its webbing ensures highly effective puncture resistance for lightweight race and tour tyres.</p>
	<p>GreenGuard® The GreenGuard® puncture belt comprises highly elastic special rubber 3 mm thick, partially made of recycling material, which is positioned on a 67 EPI carcass.</p>
	<p>PunctureGuard The PunctureGuard puncture protection belt consists of a rubber insert 3 mm thick.</p>
	<p>RaceGuard® The RaceGuard® puncture protection belt comprises two criss-crossing nylon webbings, positioned over a 67 EPI carcass.</p>
	<p>K-Guard The K-Guard puncture protection comprises a natural rubber insert, reinforced with Kevlar® fibres. Kevlar® is a high-tech fibre by DuPont, used in many items to obstruct penetrating objects, including in bulletproof vests.</p>
	<p>Performance and LiteSkin Tyres with a 50 EPI carcass - without puncture protection belt.</p>

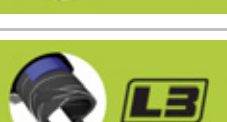
3.5.8.2 SUPERO

	<p>Level 7</p> <p>An EPS webbing layer is located beneath a 3-mm LDP layer.</p>
	<p>Level 6</p> <p>An EPS webbing layer is combined with a 1-mm layer of rubber.</p>
	<p>EPS BtB</p> <p>EPS BtB (wire-to-wire). The side walls are also protected with a poly-fibre webbing layer in addition to the tread.</p>
	<p>EPS 2</p> <p>A tyre with a 5 EPS protection level has a poly-fibre webbing layer. The webbing is located between the tread and the carcass.</p>
	<p>LDP</p> <p>A tyre with a 5 LDP protection level has an LDP puncture protection webbing layer 3 mm thick. This is an extra thick rubber layer between the tread and the carcass.</p>
	<p>EPS 1</p> <p>Tyres with Level 4 protection feature an additional dense EPS webbing layer. As a result, the tyre is light and is suitable for racing and ATB bikes.</p>
	<p>Kevlar® Inside</p> <p>Tyres with Kevlar® Inside feature a Kevlar® webbing layer 1.5 mm thick between the carcass and wheel.</p>
	<p>The carcass has 60 EPI at protection level 2 and above.</p>
	<p>APL puncture protection</p> <p>APL puncture protection offers a rubber protection layer 1 mm thick between the carcass and the tread. The carcass has between 22 and 32 EPI.</p>

PPI	Rubber insert	Inserts Combination	Webbing insert
L7		Level 7	
L6		Level 6	
L5	LDP		EPS 2 EPS BtB
L4			EPS 1
L3			Kevlar® Inside
L2			
L1	APL		

Table 33: Classification of puncture protection belts according to puncture protection level (PPL)

3.5.8.3 MAXXIS®

	<p>MaxShield (MS)</p> <p>MaxShield (MS) combines Maxxis® SilkShield all-round protection with the K2 Layer (Kevlar® composite layers).</p>
	<p>Kevlar® Composite K2</p> <p>These tyres feature an additional Kevlar® Composite K2 webbing and boast greater puncture protection than normal Kevlar® or Vectran tyres.</p>
	<p>KevlarInside</p> <p>MAXXIS tyres with KevlarInside have a puncture protection layer made of special rubber with embedded original Kevlar fibres.</p>
	<p>SilkShield (SS)</p> <p>SilkShield offer SilkWorm all-round protection from rim edge to rim edge and thus prevents cuts and other defects on the tyre side walls and under the tread.</p>
	<p>SilkWorm (SW)</p> <p>SilkWorm is a protection layer developed by Maxxis which lies beneath the tread and protects the tyres against punctures, tears and other carcass damage.</p>
	<p>MaxxProtect (MP)</p> <p>MaxxProtect tyres feature a tough fibre material which is fitted as a protection layer between the tread and the carcass.</p>
	<p>Nylon Breaker (NB)</p> <p>Positioned between the tread and carcass, the Nylon Breaker increases puncture resistance. This breaker is often fitted in two layers, thus providing even more effective protection.</p>

3.5.9 Torque

Model	Torque	Screw
3.5.9.1 Hub		
SHIMANO quick release version FH-M3050, FH-M4050, FH-MT200-B, FH-MT400, FH-MT400-B, FH-MT500, FH-MT500-B, FH-MT510, FH-MT510-B, FH-RM33, FH-RM35, FH-TX505, FH-TY505, FH-UR600 HB-M3050, HB-M4050, HB-MT200, HB-MT400, HB-MT400-B, HB-RM33 HB-TX505 SLX FH-M7000, FH-M7010, FH-M7010-B HB-M7000, HB-M7010, HB-M7010-B DEORE FH-M618, FH-M618-B, FH-M6000, FH-M6010, FH-M6010-B, HB-M618, HB-M618-B, HB-M6000, HB-M6010, HB-M6010-B Brake disc attachment screw	40 Nm	Adjustable spanner and special tool TL-LR15 (SHIMANO)
SHIMANO E-THRU quick release axle Retaining ring for brake disc	40 Nm	Special tool TL-FC36 (SHIMANO)
SHIMANO , FH-M3050, FH-M4050, FH-M7000, FH-M6000, FH-RM33, FH-RM35, FH-UR600 Attachment screw, freewheel body	35 ... 50 Nm	10 mm hex bit
SHIMANO , FH-MT200, FH-TX505, FH-TY505 Attachment screw, freewheel body	147 ... 200 Nm	12 mm hex bit
SHIMANO , FH-M7010, FH-M7010-B, FH-M6010, FH-M6010-B, FH-M618, FH-M618-B, FH-MT400, FH-MT400-B FH-MT500, FH-MT500-B, FH-MT510 FH-MT510-B Lock nut	15 ... 20 Nm	Hub spanner, 17 mm
SHIMANO , HB-M7000, HB-M6000, HB-M4050 Lock nut	10 ... 15 Nm	Hub spanner, 13 mm and 17 mm
SHIMANO , HB-M7010, HB-M7010-B, HB-M6010, HB-M6010-B, HB-M618, HB-M618-B, HB-MT400, HB-MT400-B Lock nut	21 ... 26 Nm	Hub spanner, 22 mm
SHIMANO hub dynamo E2 model	20 - 25 Nm	Screw wrench
SHIMANO hub dynamo J2 model	20 Nm	Screw wrench
SHIMANO hub dynamo J2-A model	20 Nm	Screw wrench
3.5.9.2 Shifter		
SHIMANO DEORE SL-M4100 Attachment screw	3 Nm	4 mm hex bit
SHIMANO DEORE SL-M5100 Attachment screw	3 Nm	4 mm hex bit
SHIMANO DEORE SL-M6100 Attachment screw	3 Nm	4 mm hex bit
SHIMANO DEORE XT SL-M8100 Attachment screw	3 Nm	4 mm hex bit
SHIMANO DEORE XT SL-M8130 Attachment screw	3 Nm	4 mm hex bit

SHIMANO, SLX SL-M7100 Attachment screw	3 Nm	4 mm hex bit
SHIMANO XTR SL-M9100 Attachment screw	3 Nm	4 mm hex bit
3.5.9.3 Rear derailleur		
SHIMANO for MTB/trekking Attachment screw, standard type	8–10 Nm	Hex key, 5 mm
SHIMANO for MTB/trekking Attachment screw with bracket	3–4 Nm	Hex key, 5 mm
SHIMANO for BMX bicycles Attachment screw	3–4 Nm	Adjustable spanner
SHIMANO for MTB/trekking Attachment screw for inner cable	6–7 Nm	Hex key, 4 mm/ Hex key, 5 mm/ Adjustable spanner
SHIMANO for MTB/trekking Attachment screw for the guide pulley	2.5–5 Nm	Hex key, 3 mm
SHIMANO for MTB/trekking Attachment screw for the tensioning roller	2.5–5 Nm	Hex key, 3 mm
SHIMANO for racing bicycles Attachment screw, standard type	8–10 Nm	Hex key, 5 mm
SHIMANO for racing bicycles Attachment screw with bracket	3–4 Nm	Screw wrench
SHIMANO for racing bicycles Attachment screw for inner cable	6–7 Nm	Hex key, 4 mm/ Hex key, 5 mm
SHIMANO for racing bicycles Attachment screw for pulley	2.5–5 Nm	Hex key, 3 mm
3.5.9.4 Front derailleur		
SHIMANO for MTB/trekking Attachment screw, clip type, E-type and direct fitting	5–7 Nm	Hex key, 5 mm
SHIMANO for MTB/trekking Inner bearing adapter	35–50 Nm	...
SHIMANO for MTB/trekking Top swing screw, clip type and e-type	5–7 Nm	Hex key, 5 mm/ Screw wrench, 9 mm
SHIMANO for MTB/trekking Down swing screw, clip type, direct fitting	5–7 Nm	Hex key, 5 mm
SHIMANO for racing bicycles Attachment screw	5–7 Nm	Hex key, 5 mm/ Screw wrench, 9 mm
SHIMANO for racing bicycles Attachment screw, Bowden cable	6–7 Nm	Hex key, 5 mm/
3.5.9.5 Freewheel		
SHIMANO	35 Nm	Multiple freewheel tool TL-FW30
3.5.9.6 Axle		
Conventional axle nut	35 ... 40 Nm*	
SR SUNTOUR screw-on axle 12AH2 Axle Securing screw	8–10 Nm 5–6 Nm	6 mm hex bit 5 mm hex bit
SR SUNTOUR screw-on axle 15AH2 Axle Securing screw	8–10 Nm 5–6 Nm	6 mm hex bit 5 mm hex bit

3.5.9.7 Handlebars		
Clamping screw, conventional	5 ... 7 Nm*	
CONTROL TECH, handlebar clamp with one or two screws	14 ... 16 Nm	
SHIMANO, handlebar clamp with one or two screws	20 ... 29 Nm	
3.5.9.8 Stem		
FSA, carbon quill stem,	9 Nm	15 mm spanner
3.5.9.9 Seat post		
by.schulz, G1 M8 seat clamp screw M5 fixing grub screws	20 ... 24 Nm 3 Nm	2.5 mm hex bit
by.schulz, G2 M6 seat clamp screw M5 fixing grub screws	12 ... 14 Nm 3 Nm	2.5 mm hex bit
eightpins NGS2 Seat post axle Slipper clutch Valve cover Postpin axle Rear clamping screw (saddle) M5 attachment screw for outer sleeve	8 Nm 18 Nm 0.5 Nm 8 Nm 8 Nm 0.5 Nm	6 mm hex bit 3 mm hex bit 5 mm hex bit 5 mm hex bit 3 mm hex bit 3 mm hex bit
eightpins H01 Seat post axle Slipper clutch Valve cover Postpin axle Rear clamping screw (saddle) M5 attachment screw for outer sleeve	8 Nm 18 Nm 0.5 Nm 8 Nm 8 Nm 0.5 Nm	6 mm hex bit 3 mm hex bit 5 mm hex bit 5 mm hex bit 3 mm hex bit 3 mm hex bit
LIMOTEC LimoDP Clamping screw for seat post Clamping screw for saddle	6 ... 7 Nm 7 ... 9 Nm	
SR SUNTOUR suspension seat post Seat clamp screw M5 fixing grub screws	15 ... 18 Nm 3 Nm	2.5 mm hex bit
3.5.9.10 Seat post remote control		
eightpins Attachment screw Bowden cable fastener	2.5 Nm 5 Nm	4 mm hex bit 3 mm hex bit
3.5.9.11 Pedal		
Pedal, conventional	33 ... 35 Nm	Screw wrench, 15 mm
SHIMANO Attachment screw	35–55 Nm	Screw wrench, 15 mm
3.5.9.12 Handbrake		
SHIMANO Attachment screw	6–8 Nm	Hex key, 4 mm Hex key, 5 mm
SHIMANO Attachment screw, BL-M987/ BL-M9000/BL-M9020	4–6 Nm	Hex key, 4 mm
SHIMANO, lever for disc brake Bleed nipple	4–6 Nm	Socket wrench, 7 mm
SHIMANO, lever for disc brake Bleed screw	0.3–0.5 Nm	...

3.5.9.13 Brake cable		
SHIMANO Connecting screw, handbrake	5–7 Nm	Screw wrench, 8 mm
SHIMANO Connecting screw, brake calliper, version for banjo type connection	5–7 Nm 8–10 Nm	Hex key, 3 mm Hex key, 4 mm
SHIMANO Connecting screw for brake calliper, straight version	5–7 Nm	Hex key, 3 mm
SHIMANO for racing bicycles Connecting screw for cable sleeve	5–7 Nm	Screw wrench, 8 mm
3.5.9.14 Brake linings		
SHIMANO Circlip	2–4 Nm	Hex key, 3 mm Slotted-head screwdriver
3.5.9.15 Brake calliper		
SHIMANO Adapter attachment screw and brake calliper attachment screw, version with IS brake mount	6–8 Nm	...
SHIMANO Brake calliper attachment screw, post-mount version	6–8 Nm	...
3.5.9.16 Disc brake		
SHIMANO for centre lock type Attachment screw, quick release	40–50 Nm	TL-LR15 TL-FC36/TL-LR11 Adjustable spanner
SHIMANO for centre lock type Attachment screw, nut version	40–50 Nm	TL-LR10 Screw wrench
SHIMANO for 5-hole version Attachment screws	2–4 Nm	Star bit [no. 25]
SHIMANO for 6-hole version Attachment screws	2–4 Nm	Star bit [no. 25]
3.5.9.17 V-Brake brake		
SHIMANO Attachment screw for connecting cable	6–8 Nm	Hex key, 5 mm
SHIMANO Brake shoe nut	6–8 Nm	Hex key, 5 mm
SHIMANO Bowden cable attachment screw	6–8 Nm	Hex key, 5 mm
3.5.9.18 Dual pivot rim brake		
SHIMANO Attachment screw	8–10 Nm	Hex key, 5 mm
SHIMANO, models with nut Attachment screw	8–10 Nm	Screw wrench, 10 mm
SHIMANO Attachment screw for brake shoe	5–7 Nm	Hex key, 4 mm
SHIMANO, left side Attachment screw for brake cable	6–8 Nm	Hex key, 5 mm
SHIMANO, right side Attachment screw for brake cable	1–1.5 Nm	Hex key, 2 mm

3.5.9.19 Cantilever brake		
SHIMANO Brake caliper attachment screw	5–7 Nm	Hex key, 5 mm
SHIMANO Attachment screw for brake shoe	8–9 Nm	Hex key, 5 mm Screw wrench, 10 mm
SHIMANO Bowden cable attachment screw	6–8 Nm	Hex key, 5 mm
3.5.9.20 Chaining		
SHIMANO, for MTB/trekking Largest chainring/medium-sized chainring Smallest chainring	14–16 Nm 16–17 Nm	...
SHIMANO, single version Attachment screw for crank/chaining	12 ... 14 Nm	Hex key, 5 mm/star bit [no. 30]
SHIMANO, dual version Largest chainring Smallest chainring	12 ... 14 Nm 16–17 Nm	Hex key, 5 mm/star bit [no. 30] Hex key, 5 mm/star bit [no. 30]
SHIMANO, triple design Largest chainring/medium-sized chainring Smallest chainring	12 ... 14 Nm 16–17 Nm	Hex key, 5 mm/star bit [no. 30] Hex key, 5 mm/star bit [no. 30]
SHIMANO, FC-M8000, single version Attachment screw for crank/chaining	12 ... 14 Nm	Star bit [no. 30]
SHIMANO, FC-M8000, dual version Largest chainring Smallest chainring	12 ... 14 Nm 16–17 Nm	Star bit [no. 30] Star bit [no. 30]
SHIMANO, FC-M8000, triple version Largest chainring/medium-sized chainring Smallest chainring	10 ... 12 Nm 16–17 Nm	Star bit [no. 30] Star bit [no. 30]
3.5.9.21 Crank bearing/crank set		
Conventional cartridge crank bearing	35–45 Nm	...
SHIMANO, HOLLOWTECH II/two-part crank set Linker for adapter and inner sleeve	35–50 Nm	TL-FC24/TL-FC25/TL-FC32/TL-FC36
SHIMANO, HOLLOWTECH II/two-part crank set Cap	0.7–1.5 Nm	TL-FC16 / TL-FC18
SHIMANO, HOLLOWTECH II/two-part crank set Screw for left-hand crank arm	12–14 Nm	Hex key, 5 mm
SHIMANO, OCTALINK model Linker for adapter and main body	50–70 Nm	TL-UN74-S/ TL-UN66
SHIMANO, OCTALINK model Crank set	35–50 Nm	Hex key, 8 mm Hex key, 10 mm
SHIMANO, SQUARE model Linker for adapter and body	50–70 Nm	TL-UN74-S
SHIMANO, SQUARE model Crank set	35–50 Nm	Hex key, 8 mm

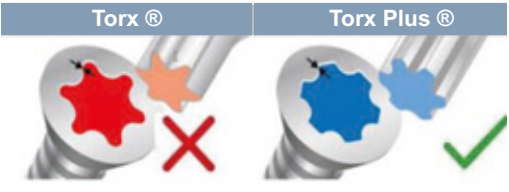
3.5.9.22 On-board computer		
BOSCH Intuvia 100 bracket		
		
Attachment screw 1, M3× 22	1 Nm	3 mm hex bit
Attachment screw 2, M3× 14	1 Nm	3 mm hex bit
BOSCH System Controller		
Attachment screw	0.5 Nm	Torx® T10
BOSCH Mini Remote		
Attachment screw	0.4 Nm (not 0.6 Nm, as written on mini-remote)	3 mm hex bit
SHIMANO SC-E5003		
Attachment screw	0.8 Nm	3 mm hex bit
3.5.9.23 Motor		
BOSCH motor BDU37xx		
6 x attachment screws for motor	20 ± 2 Nm	Torx Plus® P40, M8 × 16
		
3.5.9.24 Rechargeable battery		
BOSCH PowerPack 400/500/600/800		
4 × attachment screws for casing base locking mechanism	5 Nm	Torx® T25, M5 × 20
2 × attachment screws for cover	2 Nm	M3.5 × 12
2 × attachment screws for cover	2 Nm	M3.5 × 12 (pointed)
2 × attachment screw for bracket on cable side	1.3 Nm	Torx® T15
1 × attachment screw for bracket on cable side	5 Nm	Torx® T25, M5 × 20
2 × attachment screws for bracket on lock side	5 Nm	Torx® T25
1 × attachment screw for bracket on lock side	1 Nm	Torx® T15, M3.5 × 12
3.5.9.25 Motor cover		
BOSCH motor cover BDU37xx		
Attachment screws for lower motor cover	Initial fitting: 3 ± 0.5 Nm Retrofit: 2 ± 0.5 Nm	Torx® TX 20
Attachment screws for motor cover	Initial fitting: 3 ± 0.5 Nm Retrofit: 2 ± 0.5 Nm	Torx® TX 20, 4 × 8 mm
3.5.9.26 Chain guard		
Chain guard for BOSCH Motor BDU37xx		
Attachment screws	Max. 10 Nm	M6 × 10; head: max. 5 mm; length: max. 8.5 mm

3.5.9.27 Headlight		
FUXON headlight Attachment screw	>5 Nm	...
SUPERNOVA, M99 Pure/Pure+, V521s Attachment screw	2 Nm	M6 attachment screw, self-locking nut, washer
SUPERNOVA, M99 Pure/Pure+, V521s Stem screw	6 Nm	

*if there is no other data on the component

4 Transporting and storing

4.1 Weight and dimensions for transportation

Weight and dimensions during transportation

Type no.	Frame size	Dimensions Box [cm]	Weight** [kg]	Shipping weight [kg]
22-15-1027	45 cm	#	#	#
	50 cm	#	#	#
	55 cm	#	#	#
	60 cm	#	#	#
22-15-1028	45 cm	#	#	#
	50 cm	#	#	#
	55 cm	#	#	#
22-15-1029	45 cm	#	#	#
	50 cm	#	#	#
	55 cm	#	#	#
22-15-1038	45 cm	#	#	#
	50 cm	#	#	#
	55 cm	#	#	#
	60 cm	#	#	#
22-15-1039	45 cm	#	#	#
	50 cm	#	#	#
	55 cm	#	#	#
22-15-1040	45 cm	#	#	#
	50 cm	#	#	#
	55 cm	#	#	#

Table 34: Type number, model and pedelec type

* Pedelec weight without battery

Not yet available when the instructions were produced

4.2 Designated handles, lifting points

The box does not have any handles.

4.3 Transportation

CAUTION

Crash caused by unintentional activation

There is a risk of injury if the electric drive system is activated unintentionally.

- ▶ Remove the battery.

4.3.1 Using the transport securing system

Only applies to Pedelecs with disc brakes

CAUTION

Oil leak if no transport securing device

The brake securing device prevents the brakes from being applied accidentally during transportation or shipment. This could cause irreparable damage to the brake system or an oil leak, which will harm the environment.

- ▶ Never pull on handbrake when the wheel has been dismantled.
- ▶ Always use the transport securing system when transporting or shipping.

- ▶ Insert the **transport securing devices** between the brake linings.

⇒ Transport securing device is squeezed between the two linings and prevents undesired sustained braking which can cause brake fluid to leak out.

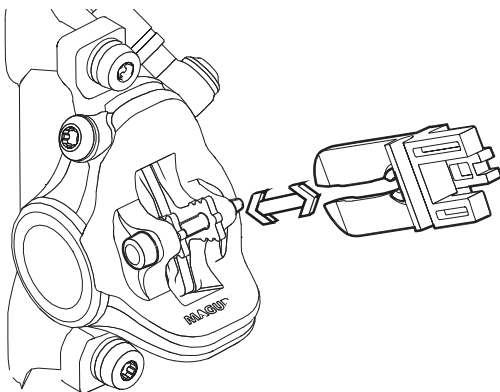

Figure 62: Fastening the transport securing device

4.3.2 Transporting the pedelec

Lithium-ion batteries store great amounts of energy. You must comply with a few precautionary measures when transporting gas cylinders.

- ▶ Discharge the battery to about 30% before placing pedelec in a vehicle to transport or take it on a trip.
- ▶ Recharge battery fully at destination.

4.3.2.1 By car

Bicycle rack systems which use the handlebars or frame to hold the pedelec in an upside-down position exert inadmissible forces on its components during transportation. This can cause the supporting parts to break.

- ▶ Remove battery and all detachable components (screen, bicycle pump, water bottle and similar) from the pedelec.
- ▶ Transport the battery in a dry, clean position where it is protected from direct sunlight.
- ▶ Never use bicycle rack systems which use the pedelec's handlebars or frame to hold the pedelec in an upside-down position. The specialist dealer will give a consultation on correct selection and safe use of a rack system.
- ▶ Take into account the weight of the ready-to-use pedelec when transporting it.

4.3.2.2 By train

Pedelecs can usually be transported in trains with a bicycle compartment.

- ✓ If you want to take your e-bike with you on the train, you should take into account that routes to platforms are not always barrier-free. You should thus allow enough time to get on and off the train.

- 1 Buy a bicycle ticket for the pedelec.
- 2 Fasten the pedelec securely in the compartment.
- 3 Take a seat in the passenger carriage.

It is possible to take a pedelec on certain high-speed train routes. The battery must remain firmly mounted during the journey and must not be charged.

4.3.2.3 By local transport

You can normally take pedelecs on local public transport, e.g. by bus or suburban rail, if you purchase a bike ticket. There may be times when this is not permitted. Local transport companies will give you relevant information.

4.3.2.4 By long-distance bus

Pedelecs can usually be taken on the long-distance bus for an extra charge, although places are limited. It is best to book early. However, not every bus line accepts pedelecs. You should check with the long-distance bus provider concerned before travelling.

4.3.2.5 On flights

It is forbidden to transport rechargeable batteries on passenger planes. Most airlines won't even transport pedelecs without batteries on passenger planes either.

It is a good idea to find out about pedelec leasing at your destination in advance if you wish to use a pedelec while on holiday. This way, you won't need to forgo pedelec riding fun during your holidays.

4.3.3 Shipping a pedelec

- ▶ Private users are not permitted to ship rechargeable batteries, neither by road nor by air freight.
- ▶ When shipping the pedelec, we recommend that you have the specialist dealer place it in proper packaging.

4.3.4 Transporting the battery

Batteries are subject to hazardous goods regulations. Undamaged batteries may be transported by private persons in road traffic.

Commercial transport operators must comply with regulations on packaging, labelling and the transportation of hazardous goods. Open contacts must be covered and the battery securely packaged.

4.3.5 Shipping the battery

The battery is considered a hazardous good and only trained persons may pack and ship a battery. Contact specialist dealer.

4.4 Storing

- ▶ Store pedelec, on-board computer, battery and charger in a clean, dry place where they are protected from sunlight. Do not store outdoors to ensure a long service life.

Optimum pedelec storage temperature	+10 ... +20 °C
--	----------------

Table 35: Optimum storage temperature for batteries and pedelec bikes

- ✓ Temperatures under -10 °C or over +40 °C must generally be avoided.
- ✓ Storage at about 10 °C to 20 °C is beneficial to a long battery life.
- ✓ Store pedelec, on-board computer, battery and charger separately.

4.4.1 Battery storage mode

Only applies to pedelecs with this equipment

The battery features a power-saving charge-to-storage mode, which minimises discharge from the battery.

- ▶ Setting the storage mode status in the settings.

4.4.2 Break in operation

Notice

The battery discharges when not in use. This can cause irreparable damage to the battery.

- ▶ The battery must be recharged every 6 months.

The battery may become damaged if it is connected permanently to the charger.

- ▶ Never connect the battery to the charger permanently.

The on-board computer battery discharges when it is not in use. This can cause irreparable damage to it.

- ▶ Recharge the on-board computer battery for at least 1 hour every 3 months.

- ▶ Remove the on-board computer from its mount if the pedelec is not going to be used for up to four weeks. Store the on-board computer away safely in a dry environment at room temperature.

- ▶ If the pedelec is removed from service for longer than four weeks, you need to prepare it for a break in operation.

4.4.2.1 Preparing a break in operation

- ✓ Remove the rechargeable battery from the pedelec. Charge battery to about 30%–60%.
- ✓ The pedelec needs to be cleaned with a damp cloth and preserved with wax spray. Never wax the friction surfaces of the brake.
- ✓ Before longer periods without use, it is recommendable to have your specialist dealer carry out an inspection and basic cleaning and apply preservative agent.
- ✓ Pump tyres to maximum pressure. The side wall will be squashed and damaged if the pedelec stands on flat tyres.

4.4.2.2 Carrying out a break in operation

- 1 Store the pedelec, battery and charger in a dry, clean environment. We recommend storing them in uninhabited rooms with smoke alarms. Dry locations with an ambient temperature between 10 °C and 20 °C are ideal.
- 2 Check the battery level after 6 months. If only one LED on the battery level indicator lights up, recharge the battery to around 30%–60%.
- 3 Recharge the display battery for at least 1 hour every 3 months.
- 4 Check the tyre pressure with an air gauge on a regular basis.
- 5 Check brake on a regular basis.
- 6 Deflect suspension fork and rear frame damper regularly to ensure a little oil reaches the seals and the suspension elements remain smooth.



5 Assembly

WARNING

Risk of eye injury

Problems may arise if components are set incorrectly. They may cause serious injuries to the face.

- ▶ Always wear safety glasses to protect eyes when assembling pedelecs.

CAUTION

Crash and crushing hazard caused by unintentional activation

There is a risk of injury if the electric drive system is activated unintentionally.

- ▶ Remove the battery.

- ✓ Assemble the pedelec in a clean, dry environment.
- ✓ The *Work environment* temperature should be between 15 °C and 25 °C.
- ✓ The fitting stand used must be approved for a maximum weight of least 30 kg.

5.1 Unpacking

The packaging material consists mainly of cardboard and plastic film.

- ▶ Dispose of the packaging in accordance with the regulatory requirements (see Section 10).
- ⇒ Pedelecs are fully assembled in the factory for test purposes and then dismantled for transportation. The pedelec is 95% to 98% pre-assembled.

Scope of delivery

<input type="checkbox"/>	1 pre-assembled pedelec
<input type="checkbox"/>	1 front wheel
<input type="checkbox"/>	2 pedals
<input type="checkbox"/>	2 quick releases (optional)
<input type="checkbox"/>	1 charger
<input type="checkbox"/>	1 set of operating instructions on CD
<input type="checkbox"/>	1 battery (supplied separately from the pedelec)

5.2 Required tools

The following tools are required to assemble the pedelec:

	Knife
	Ring spanners 8 mm, 9 mm, 10 mm, 13 mm, 14 mm and 15 mm
	Torque wrench Working range 5... 40 Nm
	by.schulz handlebars: TORX® bits: T50, T55, and T60
	Hex key 2 mm, 2.5 mm, 3 mm, 4 mm, 5 mm, 6 mm and 8 mm
	Cross-recess screwdriver
	Slotted-head screwdriver

Table 36: Tools required for assembly



5.3 Commissioning

Only trained specialist staff may perform initial commissioning since initial commissioning of the pedelec requires special tools and specialist knowledge.

Experience has shown that a pedelec which has not yet been sold is automatically handed to customers as soon as it appears ready to ride.

- ▶ It makes sense to prepare each pedelec so that it is fully ready for use immediately after being assembled.
- ▶ The assembly report (see Section 11.2) describes all safety-relevant inspections, tests and maintenance tasks.
- ▶ All assembly work must be completed to ensure the pedelec is ready to ride.
- ▶ Complete an assembly report to document quality assurance (see Section 11.1).

5.3.1 Checking the battery

The battery must be checked before it is charged for the first time.

- ▶ Press the **On-Off button (battery)**.
- ⇒ If none of the LEDs on the **battery level indicator** light up, the battery may be damaged.
- ⇒ The battery may be fully charged if at least one, but not all, of the LEDs on the **battery level indicator** lights up.



5.3.2 Preparing the wheel

There is an arrow on the sides of the tyres with the inscription ROTATION to show the direction of rotation. The inscription says DRIVE on older tyres. The rotation direction arrow indicates the recommended direction of rotation. On road tyres, the direction of rotation is mainly for optical reasons.



Figure 63: Rotation direction arrow

The direction of rotation is much more important on off-road terrain because the tread creates an interlock with the ground. While the rear wheel needs to transmit the drive forces, the front wheel is responsible for transmitting braking and steering forces. Drive and braking forces have different directions of action. This is why some tyres are mounted on the front and rear wheels in opposite directions. On these tyres, there are two rotation direction arrows:

- The FRONT rotation direction arrow indicates the recommended direction of rotation for the front wheel.
- The REAR rotation direction arrow indicates the recommended direction of rotation for the rear wheel.



Figure 64: Rotation direction arrow on MTB tyres

- ▶ The rotation direction arrow must point in the direction of travel when the wheel is placed in the fork.
- ▶ There are also non-directional tyre profiles with no rotation direction arrow.



5.3.3 Installing the wheel in the SUNTOUR fork

Only applies to Suntour forks with this equipment

5.3.3.1 Screw-on axle (12AH2 and 15AH2)

Only applies to Suntour forks with this equipment

- ✓ Before installing the wheel, ensure that the O-ring is in the right position on the thread piece.
- 1 Insert the front wheel into the fork ends.
- 2 Insert the axle into the hub on the drive side.

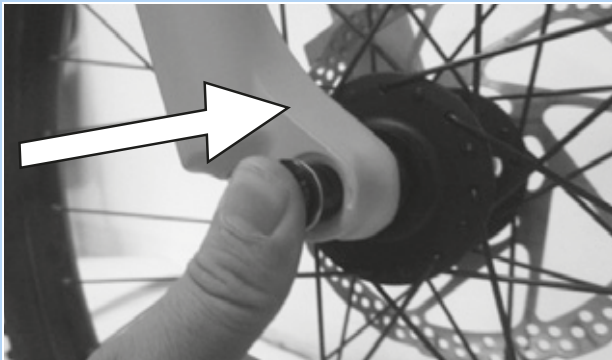

Figure 65: Inserting the axle in the direction of the arrow

- 3 Use a 6 mm hex key to tighten the axle using between 8 and 10 Nm. The axle thread must be visible.



Figure 66: Tighten the axle in the direction of the arrow

- 4 Insert the securing screw on the non-drive side.



Figure 67: Inserting the securing screw

- 5 Tighten the securing screw with a 5 mm hex key using between 5 and 6 Nm.



Figure 68: Tightening the securing screw

⇒ The wheel is now fitted.



5.3.3.2 20 mm cross axle

Only applies to Suntour forks with this equipment

CAUTION

Crash caused by loose cross axle

A faulty or incorrectly installed cross axle may become caught in the brake disc and block the wheel. This will cause a crash.

- ▶ Never fit a defective cross axle.

Crash caused by faulty or incorrectly installed cross axle

The brake disc becomes very hot during operation. Parts of the cross axle may become damaged as a result. The cross axle becomes loose. This will cause a crash with injuries.

- ▶ The cross axle and the brake disc must be opposite one another.

Crash caused by incorrectly set cross axle

Insufficient clamping force will result in unfavourable transmission of force. The suspension fork or the quick release axle may break. This will cause a crash with injuries.

- ▶ Never fasten the cross axle with a tool (e.g. hammer or pliers).

- 1 Insert the cross axle into the hub on the drive side.

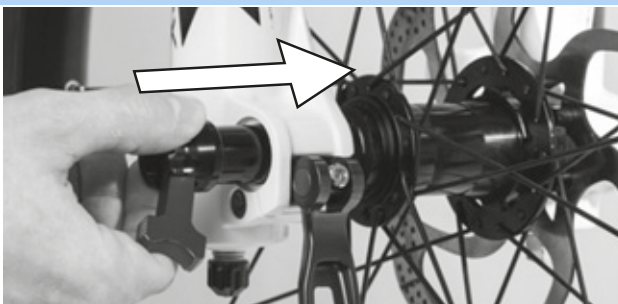

Figure 69: Inserting the cross axle in the direction of the arrow

- 2 Tighten the cross axle with the red handle.

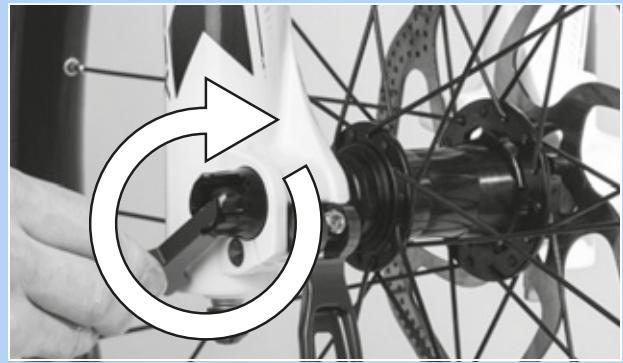

Figure 70: Tighten the axle in the direction of the arrow

- 3 Push red lever into the cross axle.

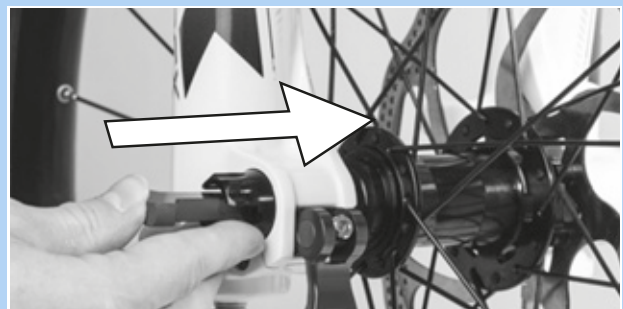

Figure 71: Pushing the red lever in the direction of the arrow

- 4 Closing the quick release lever.



Figure 72: Pressing the quick release lever in the direction of the arrow

⇒ The cross axle is secured.



- 5 Check the position and clamping force of the quick release lever. The quick release lever must be flush with the shock absorber.



Figure 73: Perfect position for the clamping lever

- 6 Use 4 mm hexagon socket spanner to adjust the clamping lever clamping force if required.

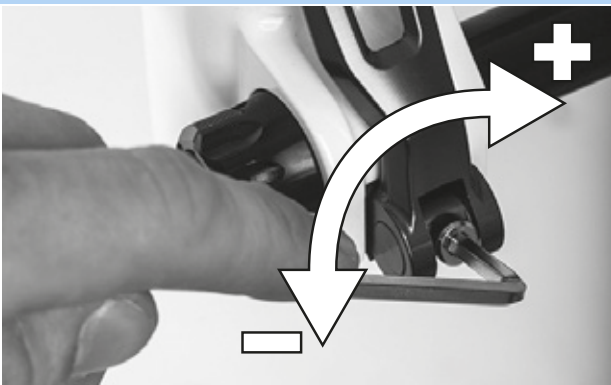

Figure 74: Adjusting the quick release clamping force

- 7 Check the quick release lever position and clamping force.

⇒ The wheel is now fitted.



5.3.3.3 Q-LOC quick release

Only applies to Suntour forks with this equipment

CAUTION

Crash caused by unfastened quick release

A faulty or incorrectly installed quick release may become caught in the brake disc and block the wheel. This will cause a crash.

- ▶ Never fit a defective quick release.

Crash caused by faulty or incorrectly installed quick release

The brake disc becomes very hot during operation. Parts of the quick release may become damaged as a result. The quick release comes loose. This will cause a crash with injuries.

- ▶ The front wheel quick release lever and the brake disc must be situated on opposite sides.

Crash caused by incorrectly set clamping force

Excessively high clamping force will damage the quick release and cause it to lose its function. Insufficient clamping force will result in unfavourable transmission of force. The suspension fork or the quick release may break. This will cause a crash with injuries.

- ▶ Never fasten a quick release using a tool (e.g. hammer or pliers).
- ▶ Only use the clamping lever with the specified set clamping force.

- ✓ Before installing, ensure that the quick release flange is extended. Open the lever fully.

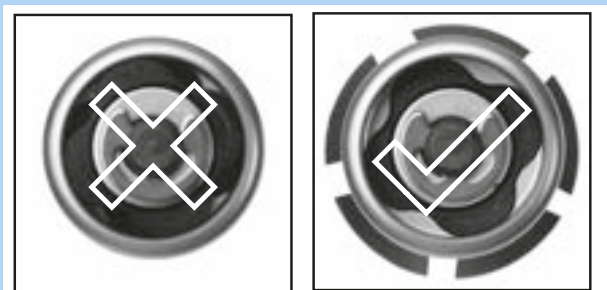

Figure 75: Closed and opened flange

- 1 Push in the quick release until you can hear a click. Make sure that the flange is extended.



Figure 76: Inserting the quick release in the direction of the arrow

- 2 Adjust tensioning with half-open clamping lever until the flange reaches the fork end.

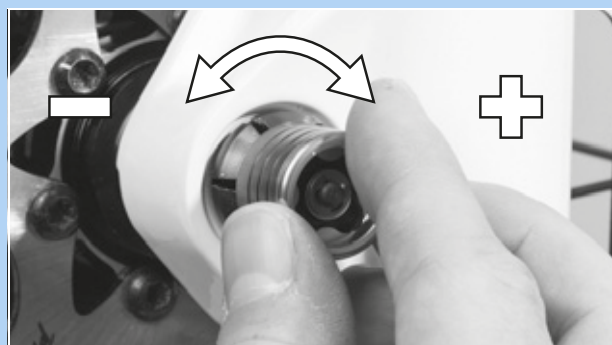

Figure 77: Adjusting the clamping

- 3 Fully close the quick release. Check that it is firmly in place and adjust it on the flange if necessary.



Figure 78: Closing the quick release

- ⇒ The wheel is now fitted.



5.3.4 Preparing the LIMOTEC seat post

Only applies to pedelecs with this equipment

- 1 Use the seat height formula to calculate the optimum seat post height for leg length:
Seat height (SH) = inner leg length (I) \times 0.9
- 2 Lower the seat post further into the seat tube
- 3 The seat post Bowden cable must be tightened in the frame up to the remote control to the same length as the seat post was lowered.
- 4 Trim the seat post Bowden cable on the handlebars if necessary.



5.4 Preparing the battery

5.4.1 Checking the battery

The battery must be checked before it is charged for the first time.

1 Press the **On-Off button (battery)**.

- ⇒ If none of the LEDs on the battery level indicator light up, the battery may be damaged.
- ⇒ The battery may be fully charged if at least one, but not all, of the LEDs on the battery level indicator lights up.

5.4.2 Retrofitting the battery locking lever

The battery locking lever can be retrofitted to SuperCore or UltraCore batteries if they do not have one.

5.4.2.1 Preparing the frame

1 Cut out the drilling template in Section 11.4 along the blue dotted line.

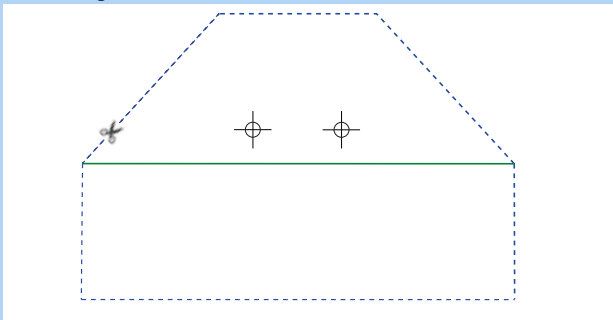

Figure 79: Cutting out along the blue line

2 Fold drilling template along green dotted line.

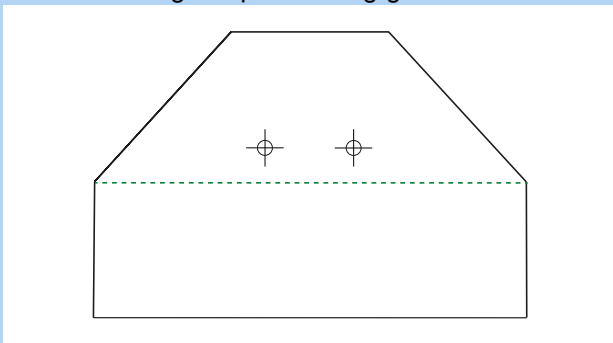

Figure 80: Folding along the green line (line 1)

- 3 Place and position drilling template on frame.
- 4 Stick drilling template to frame.
- 5 Make hole mark.

6 Pre-drill hole 3.3 mm in diameter (M4).

7 Cut M4 thread.

5.4.2.2 Fitting the locking lever

1 Insert the countersunk screws (1) into the base plate (2).

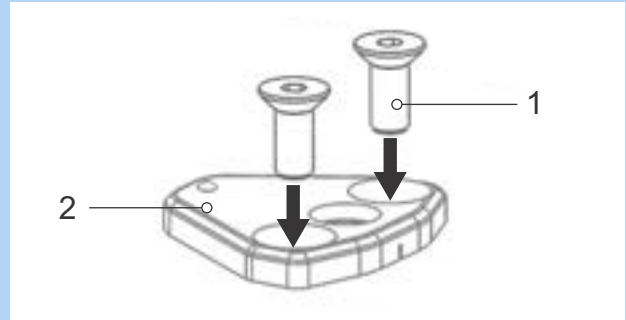

Figure 81: Inserting countersunk screws into base plate

2 Join the locking lever to the base plate using the chaining screws. Use a thread locker.

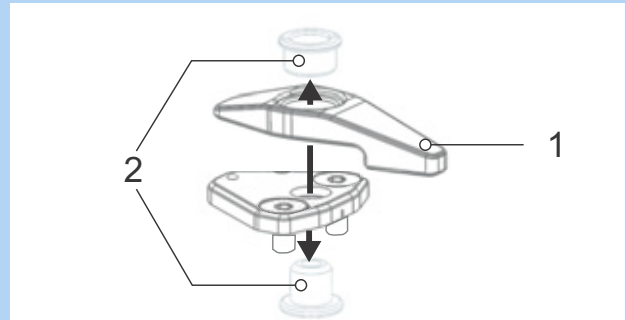

Figure 82: Connect locking lever with base plate

3 Fasten countersunk screws into the frame using a M4 Allen key. Use a thread locker.

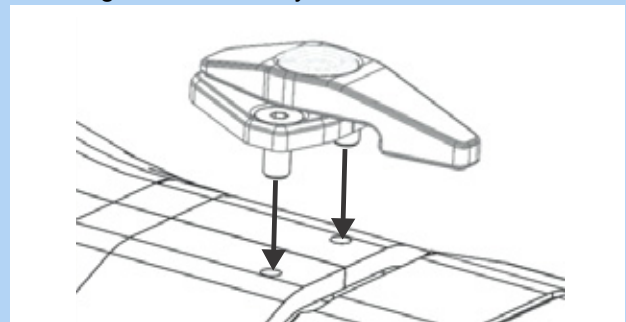

Figure 83: Screwing lever to frame



5.4.3 Fitting the pedals

The pedals have two different threads to ensure they don't come loose while the rider is pedalling.

- The pedal on the left facing the direction of travel has a left-hand thread and is marked L.
- The pedal on the right facing the direction of travel has a right-hand thread and is marked R.

The mark is either on the top end, the axle or the pedal body.



Figure 84: Example of markings on pedals

- 1 Coat threads in both pedals with waterproof grease.
- 2 Turn the pedal marked L anti-clockwise by hand into the crank arm on the left as seen when facing the direction of travel.

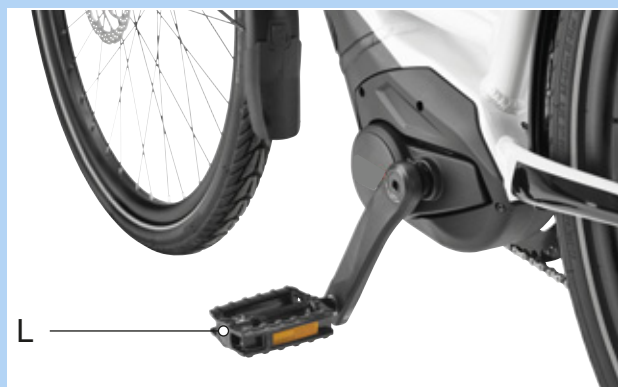

Figure 85: L-pedal in the left-hand crank arm

- 3 Turn the pedal marked R anti-clockwise by hand into the crank arm on the right as seen when facing the direction of travel.



Figure 86: R-pedal in the right-hand crank arm

- 4 Use a 15 mm spanner to fasten the left-hand pedal thread in an anti-clockwise direction and the right-hand pedal in a clockwise direction with a torque between 33 Nm and 35 Nm.



5.4.4 Checking the stem and handlebars

5.4.4.1 Checking the connections

- 1 Stand in front of the pedelec. Clamp the front wheel between your legs. Grasp the handlebar grips.
- 2 Try to twist the handlebars against the direction of the front wheel.
⇒ The stem must not move or twist.
- 3 If the stem can be twisted, check fastening.
⇒ If the stem cannot be fastened, contact your specialist dealer.

5.4.4.2 Checking stem is firmly in position

- 1 Press full body weight on the handlebars.
⇒ The handlebars must not move downwards in the fork.

Stem with clamping lever version I

- 2 If the handlebars should move, increase the lever tension in the clamping lever.
- 3 Turn knurled nut in a clockwise direction with the clamping lever open.
- 4 Close clamping lever and check stem is firmly in position again.
- 5 If the handlebars cannot be fastened, contact your specialist dealer.

Stem with clamping lever version II and stem with screw

- ▶ If the handlebars cannot be fastened, contact your specialist dealer.

5.4.4.3 Checking the bearing clearance

- 1 Place the fingers of one hand on the upper headset cup. Pull the front wheel brake with the other hand and try to push the pedelec backwards and forwards.
Keep in mind that there may be noticeable backlash due to worn-out bearing bushes or brake lining backlash in suspension forks and disc brakes.
⇒ The headset cup halves must not move towards one another.
- 2 Adjust bearing clearance as per the stem repair manual as quickly as possible; otherwise, the bearing will become damaged. Contact specialist dealer.

5.5 Selling the pedelec

- ▶ Complete pedelec pass on the operating instructions envelope.
- ▶ Note down the manufacturer and the number of the battery key.
- ▶ Adjust the pedelec; see Section 6.5.
- ▶ Adjust the stand and shifter.
- ▶ Brief pedelec rider on all the pedelec's functions (see Section 6.3).

6 Operation

6.1 Risks and hazards

WARNING

Injuries and death caused by blind spots

Other road users, trucks, cars and pedestrians often underestimate the speed of pedelecs. Likewise, other road users frequently do not see pedelecs. This may lead to an accident with serious injuries or even death.

- ▶ Wear a helmet. The helmet must have a reflective strip or a light in a clearly visible colour.
- ▶ Clothing should be retroreflective or as light as possible. Fluorescent materials are also suitable. High-visibility jackets and straps on your upper body ensure even greater safety.
- ▶ Always take a defensive approach to riding.
- ▶ Avoid the blind spots of vehicles turning off the road. Reduce speed as a precaution when other road users turn right.

Injuries and death caused by riding incorrectly

A pedelec is not a bicycle. Mistakes made while riding and underestimated speeds quickly lead to hazardous situations. This can cause an accident with serious or fatal injuries.

- ▶ Slowly get used to road traffic and speed before riding at speeds over 12 km/h, especially if you have not ridden a bike for some time.
- ▶ Increase the levels of assistance gradually.
- ▶ Practice braking hard on a regular basis.
- ▶ Take and complete a riding safety course.

WARNING

Injuries and death caused by distraction

A lack of concentration while riding increases the risk of an accident. This may cause a crash with serious injuries.

- ▶ Never allow yourself to be distracted by the on-board computer or your mobile phone.
- ▶ Stop the pedelec if you want to make inputs on the on-board computer other than change the level of assistance. Only enter data when stationary.

CAUTION

Crash caused by loose clothing

Laces, scarves and other loose items may become entangled in the spokes on the wheels and the chain drive. This may cause a crash with injuries.

- ▶ Wear sturdy footwear and close-fitting clothing.

Crash caused by difficult-to-spot damage

If the pedelec topples over or you have a fall or an accident, there may be difficult-to-spot damage to components such as the brake system, quick releases or frame. This may cause a crash with injuries.

- ▶ Take pedelec out of service. Contact specialist dealer.

**CAUTION****Crash caused by material fatigue**

Intensive use can cause material fatigue. A component may suddenly fail in case of material fatigue. This may cause a crash with injuries.

- ▶ Remove the pedelec from service immediately if there are any signs of material fatigue. Have your specialist dealer inspect the component.
- ▶ Arrange the mandatory inspection appointments with your specialist dealer on a regular basis. During the major inspection, the specialist dealer will inspect the pedelec for any signs of material fatigue on the frame, fork, suspension element mountings (if there are any) and components made of composite materials.

Carbon becomes brittle when exposed to heat radiation such as heating. This can cause the carbon part to break and result in a crash with injuries.

- ▶ Never expose carbon components parts on the pedelec to strong sources of heat.

Crash caused by poor road conditions

Loose objects, such as branches and twigs, may become caught in the wheels and cause a crash with injuries.

- ▶ Be aware of the road conditions.
- ▶ Ride slowly and brake in good time.

The *tyres* may slip on wet roads. In wet conditions you must also expect a longer braking distance. The braking sensation differs from the usual sensation. This can cause loss of control or a crash, which may result in injuries.

- ▶ Ride slowly and brake in good time when it is raining.

**CAUTION****Crash caused by soiling**

Heavy soiling can impair pedelec functions, such as braking. This may cause a crash with injuries.

- ▶ Remove coarse soiling before riding.

Notice

Heat or direct sunlight can cause the *tyre pressure* to increase above the permitted maximum pressure. This can destroy the *tyres*.

- ▶ Park pedelec in the shade.
- ▶ On hot days, regularly check the *tyre pressure* and adjust it as necessary.

When riding downhill, high speeds may be reached. The pedelec is only designed to exceed a speed of 25 km/h for short intervals. The *tyres* in particular can fail if exposed to a continuous load.

- ▶ Use the brakes to decelerate the pedelec if you reach speeds greater than 25 km/h.

Moisture penetrating at low temperatures may impair individual functions due to the open structural design.

- ▶ Always keep the pedelec dry and free from frost.
- ▶ If the pedelec is used at temperatures below 3 °C, the specialist dealer must perform a major inspection beforehand and prepare it for winter use.

Off-road riding subjects the joints in the arms to severe strain. Take a break from riding every 30 to 90 minutes, depending on the road surface conditions and your physical fitness.

6.2 Tips for a greater range

The pedelec's range depends on many influencing factors. A single battery charge may only last fewer than 20 kilometres but much more than 100 is also possible. Test the pedelec's range before embarking on longer rides. There are a few tips which will generally help you maximize range.

Suspension elements

- ▶ Only open suspension fork and damper when necessary on terrain or gravel paths. Block suspension fork and damper on tarmacked roads or on hills.

Mileage

The more own physical effort the rider makes, the greater the attainable range is.

- ▶ Shift down 1 to 2 gears to increase the induced power and pedalling frequency.

Pedalling frequency

- ▶ Ride using pedalling frequencies of over 50 revolutions per minute. This optimises the electric drive's efficiency.
- ▶ Avoid pedalling very slowly.

Weight

- ▶ Minimise the total weight of pedelec and baggage.

Stopping and starting

- ▶ Ride long distances at a constant speed.
- ▶ Avoid stopping and starting frequently.

Level of assistance

- ▶ The lower the selected levels of assistance are, the greater the range is.

Gear switching habits

- ▶ Use a low gear and a low level of assistance on hills and when setting off.
- ▶ Switch up a gear depending on the speed and terrain.
- ▶ 50-80 crank rotations per minute are optimal.
- ▶ Avoid high stress loads on the crank during a gear change.
- ▶ Switch gear back in good time, e.g. before inclines.

Tyres

- ▶ Always select the right tyres for the surface type. As a general rule, narrower treads move along more easily than heavier ones. Long studs and large grooves usually have an unfavourable effect on energy consumption.
- ▶ When riding on asphalt, it is important to always use the maximum permitted tyre pressure.
- ▶ When riding off-road, on gravel tracks or soft woodland or meadow soils, it is important to remember: the lower the tyre pressure is, the greater the rolling resistance is and thus the greater electric drive system energy consumption is.

Rechargeable battery

Electrical resistance increases as the temperature drops. Battery performance is reduced. As a result, you should expect the range to be shorter than normal in winter.

- ▶ Use a thermal protection sleeve on the battery in winter.

The range also depends on the battery's age, charge level and state of repair.

- ▶ Maintain the battery and replace older batteries where necessary.

6.3 Error message

6.3.1 Display

The electric drive system monitors itself continuously and indicates a known hazard with a warning symbol or displays a number as an error message if a known error is detected. The system may switch off automatically depending on the type of error. The pedelec can still be used as a normal bicycle even if the motor no longer provides assistance.

6.3.1.1 Status LED

There is a status LED in the top left-hand corner of the display screen.

Colour	Flash sequence	Status
GREEN	Lights up	1 Connect system to the maintenance tool at the specialist dealer's.
RED	Lights up	1 Restart system. 2 If the remote continues to light up red, have the component replaced at the specialist dealer's.
RED	Flashes	1 Restart system. 2 If the remote continues to light up red, have the component replaced at the specialist dealer's.

Table 37: Status LED

6.3.1.2 Warnings

Hazardous situations are indicated with warning symbols on the display screen.







Symbol	Description	Method of resolution
	Temperatures are below 4 °C	<ul style="list-style-type: none"> ▶ Take care while riding. ▶ Provide winter protection.
	The system warns of a fault.	<ol style="list-style-type: none"> 1 Re-start the system. 2 Contact your specialist dealer if the problem persists.
	A major inspection is due	<ul style="list-style-type: none"> ▶ Check whether the buttons are jammed because dirt has accumulated between them, for example. ▶ Clean buttons if necessary.
	Motor overheating	<p>The available riding assistance power is limited.</p> <ul style="list-style-type: none"> ▶ Leave pedelec to cool down
	Reduction in power	<p>The available riding assistance power is limited.</p> <ul style="list-style-type: none"> ▶ Contact specialist dealer.
	Low tyre pressure	<p>Function is only available with the tyre pressure sensor.</p> <ul style="list-style-type: none"> ▶ Check tyre pressure and adjust if necessary.

Table 38: List of display screen warning symbols

6.3.1.3 Error messages

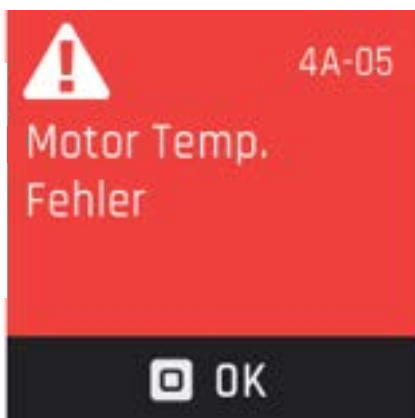

Figure 87: Example of an error message

- ▶ Press on the menu button.
- ⇒ The error is acknowledged.
- ⇒ The display screen shows the DRIVE MAIN MENU.

If the error cannot be acknowledged, use the corresponding solution from the following tables.

Code	Description	Method of resolution
0A-01, 0B-01	Remote Communication Error	<ol style="list-style-type: none"> 1 Restart system 2 Contact your specialist dealer if the problem persists.
0A-02, 0B-02	Remote-Display Communication Error	<ol style="list-style-type: none"> 1 Restart system 2 Switch off system. 3 Remove on-board computer from mount, check contacts and clean if necessary. 4 Insert remote. 5 Start system. 6 Contact your specialist dealer if the problem persists.
0A-03, 0A-04, 0A-05, 0A-06, 0B-03, 0B-04, 0B-05, 0B-06	Remote-Battery Communication Error	<ol style="list-style-type: none"> 1 Restart system 2 Switch off system. 3 Remove battery from mount, check contacts and clean if necessary. 4 Insert the battery. 5 Start system. 6 Contact your specialist dealer if the problem persists.
0A-07, 0B-07	Remote-Speednode Communication Error	<ol style="list-style-type: none"> 1 Restart system 2 Contact your specialist dealer if the problem persists.

Table 39: List of display screen error messages

Code	Description	Method of resolution
0A-08, 0B-08	Remote-Gear Shift Communication Error	<ol style="list-style-type: none"> 1 Restart system 2 Contact your specialist dealer if the problem persists.
0A-0A, 0B-0A	Remote-Charger Communication Error	<ol style="list-style-type: none"> 1 Restart system 2 Switch off system. 3 Disconnect charger from system and socket. 4 Wait until the status LED goes out. 5 Check plug contacts on pedecec and charger and clean if necessary. 6 Plug charger into the socket again. 7 Plug charger into the system again. 8 Start system. 9 Contact your specialist dealer if the problem persists.
0A-0B, 0B-0B	Remote-Lock Communication Error	<ol style="list-style-type: none"> 1 Restart system 2 Contact your specialist dealer if the problem persists.
0C-00	Remote Identification Error	<ol style="list-style-type: none"> 1 Restart system 2 Contact your specialist dealer if the problem persists.
0C-01	Remote motor Identification error	<ol style="list-style-type: none"> 1 Restart system 2 Contact your specialist dealer if the problem persists.
0C-02	Remote display Identification error	<ol style="list-style-type: none"> 1 Restart system 2 Switch off system. 3 Remove on-board computer from mount, check contacts and clean if necessary. 4 Insert remote. 5 Start system. 6 Contact your specialist dealer if the problem persists.
0C-03, 0C-04, 0C-05, 0C-06,	Remote battery Identification error	<ol style="list-style-type: none"> 1 Restart system 2 Switch off system. 3 Remove battery from mount, check contacts and clean if necessary. 4 Insert the battery. 5 Start system. 6 Contact your specialist dealer if the problem persists.
0C-07	Remote-Speednode Identification Error	<ol style="list-style-type: none"> 1 Restart system 2 Contact your specialist dealer if the problem persists.

Table 39: List of display screen error messages

Code	Description	Method of resolution
0C-08	Remote gear shift identification Error	<ol style="list-style-type: none"> 1 Restart system 2 Contact your specialist dealer if the problem persists.
0C-0A	Remote-Charger Identification Error	<ol style="list-style-type: none"> 1 Restart system 2 Switch off system. 3 Disconnect charger from system and socket. 4 Wait until the status LED goes out. 5 Check plug contacts on pedevec and charger and clean if necessary. 6 Plug charger into the socket again. 7 Plug charger into the system again. 8 Start system. 9 Contact your specialist dealer if the problem persists.
0C-0B	Remote-Lock Identification Error	<ol style="list-style-type: none"> 1 Restart system 2 Contact your specialist dealer if the problem persists.
0D-01	Motor Authentication Error	<ol style="list-style-type: none"> 1 Restart system 2 Contact your specialist dealer if the problem persists.
0D-02	Display Authentication error	<ol style="list-style-type: none"> 1 Restart system 2 Switch off system. 3 Remove on-board computer from mount, check contacts and clean if necessary. 4 Insert remote. 5 Start system. 6 Contact your specialist dealer if the problem persists.
0D-03 0D-04, 0D-05, 0D-06,	Rechargeable battery Authentication error	<ol style="list-style-type: none"> 1 Restart system 2 Switch off system. 3 Remove battery from mount, check contacts and clean if necessary. 4 Insert the battery. 5 Start system. 6 Contact your specialist dealer if the problem persists.
0D-07	Speednode Authentication Error	<ol style="list-style-type: none"> 1 Restart system 2 Contact your specialist dealer if the problem persists.
0D-08	Gear Shift Authentication Error	<ol style="list-style-type: none"> 1 Restart system 2 Contact your specialist dealer if the problem persists.

Table 39: List of display screen error messages

Code	Description	Method of resolution
0D-0A	Charger Authentication Error	<ol style="list-style-type: none"> 1 Restart system 2 Switch off system. 3 Disconnect charger from system and socket. 4 Wait until the status LED goes out. 5 Check plug contacts on pedevec and charger and clean if necessary. 6 Plug charger into the socket again. 7 Plug charger into the system again. 8 Start system. 9 Contact your specialist dealer if the problem persists.
0D-0B	Lock Authentication Error	<ol style="list-style-type: none"> 1 Restart system 2 Contact your specialist dealer if the problem persists.
0E-xx	Remote Authentication Error	<ol style="list-style-type: none"> 1 Restart system 2 Contact your specialist dealer if the problem persists.
0F-01	Motor Update Error	<ol style="list-style-type: none"> 1 Restart system 2 Contact your specialist dealer if the problem persists.
0F-02	Display Update Error	<ol style="list-style-type: none"> 1 Restart system 2 Switch off system. 3 Remove on-board computer from mount, check contacts and clean if necessary. 4 Insert remote. 5 Start system. 6 Contact your specialist dealer if the problem persists.
0F-03 0F-04, 0F-05, 0F-06,	Battery Update Error	<ol style="list-style-type: none"> 1 Restart system 2 Switch off system. 3 Remove battery from mount, check contacts and clean if necessary. 4 Insert the battery. 5 Start system. 6 Contact your specialist dealer if the problem persists.
0F-07	Speednode Update Error	<ol style="list-style-type: none"> 1 Restart system 2 Contact your specialist dealer if the problem persists.
0F-08	Gear Shift Update Error	<ol style="list-style-type: none"> 1 Restart system 2 Contact your specialist dealer if the problem persists.

Table 39: List of display screen error messages

Code	Description	Method of resolution
0F-0A	Charger Update Error	<ol style="list-style-type: none"> 1 Restart system 2 Switch off system. 3 Disconnect charger from system and socket. 4 Wait until the status LED goes out. 5 Check plug contacts on pedelec and charger and clean if necessary. 6 Plug charger into the socket again. 7 Plug charger into the system again. 8 Start system. 9 Contact your specialist dealer if the problem persists.
0F-0B	Lock Update Error	<ol style="list-style-type: none"> 1 Restart system 2 Contact your specialist dealer if the problem persists.
10-xx	Remote Software Error	<ol style="list-style-type: none"> 1 Restart system 2 Contact your specialist dealer if the problem persists.
11-xx	Battery-Remote Communication Error	<ol style="list-style-type: none"> 1 Restart system 2 Contact your specialist dealer if the problem persists.
12-01	Remote motor Pairing error	<ol style="list-style-type: none"> 1 Restart system 2 Contact your specialist dealer if the problem persists.
12-02	Remote display Pairing error	<ol style="list-style-type: none"> 1 Restart system 2 Switch off system. 3 Remove on-board computer from mount, check contacts and clean if necessary. 4 Insert remote. 5 Start system. 6 Contact your specialist dealer if the problem persists.
12-03, 12-04, 12-05, 12-06	Remote battery Pairing error	<ol style="list-style-type: none"> 1 Restart system 2 Switch off system. 3 Remove battery from mount, check contacts and clean if necessary. 4 Insert the battery. 5 Start system. 6 Contact your specialist dealer if the problem persists.
12-07	Remote-Speednode Pairing Error	<ol style="list-style-type: none"> 1 Restart system 2 Contact your specialist dealer if the problem persists.

Table 39: List of display screen error messages

Code	Description	Method of resolution
12-08	Remote-Gear Shift Pairing Error	<ol style="list-style-type: none"> 1 Restart system 2 Contact your specialist dealer if the problem persists.
12-0A	Remote-Charger Pairing Error	<ol style="list-style-type: none"> 1 Restart system 2 Switch off system. 3 Disconnect charger from system and socket. 4 Wait until the status LED goes out. 5 Check plug contacts on pedelec and charger and clean if necessary. 6 Plug charger into the socket again. 7 Plug charger into the system again. 8 Start system. 9 Contact your specialist dealer if the problem persists.
12-0B	Remote-Lock Pairing Error	<ol style="list-style-type: none"> 1 Restart system 2 Contact your specialist dealer if the problem persists.
13-xx	Remote Internal Error	<ol style="list-style-type: none"> 1 Re-start the system. 2 Contact your specialist dealer if the problem persists.
14-xx	Remote configuration error	<ol style="list-style-type: none"> 1 Re-start the system. 2 Contact your specialist dealer if the problem persists.
15-01	Remote motor Pairing error	<ol style="list-style-type: none"> 1 Restart system 2 Contact your specialist dealer if the problem persists.
15-02	Remote display Pairing error	<ol style="list-style-type: none"> 1 Restart system 2 Switch off system. 3 Remove on-board computer from mount, check contacts and clean if necessary. 4 Insert remote. 5 Start system. 6 Contact your specialist dealer if the problem persists.
15-03, 15-04, 15-05, 15-06	Remote battery Pairing error	<ol style="list-style-type: none"> 1 Restart system 2 Switch off system. 3 Remove battery from mount, check contacts and clean if necessary. 4 Insert the battery. 5 Start system. 6 Contact your specialist dealer if the problem persists.

Table 39: List of display screen error messages

Code	Description	Method of resolution
15-07	Remote-Speednode Pairing Error	<ol style="list-style-type: none"> 1 Restart system 2 Contact your specialist dealer if the problem persists.
15-08	Remote-Gear Shift Pairing Error	<ol style="list-style-type: none"> 1 Restart system 2 Contact your specialist dealer if the problem persists.
15-0A	Remote-Charger Pairing Error	<ol style="list-style-type: none"> 1 Restart system 2 Switch off system. 3 Disconnect charger from system and socket. 4 Wait until the status LED goes out. 5 Check plug contacts on pedelec and charger and clean if necessary. 6 Plug charger into the socket again. 7 Plug charger into the system again. 8 Start system. 9 Contact your specialist dealer if the problem persists.
15-0B	Remote-Lock Pairing Error	<ol style="list-style-type: none"> 1 Restart system 2 Contact your specialist dealer if the problem persists.
16-00	Remote Theft Detection	<ol style="list-style-type: none"> 1 Re-start the system. 2 Contact your specialist dealer if the problem persists.
16-01	Motor Theft Detection	<ol style="list-style-type: none"> 1 Restart system 2 Contact your specialist dealer if the problem persists.
16-02	Display Theft Detection	<ol style="list-style-type: none"> 1 Restart system 2 Switch off system. 3 Remove on-board computer from mount, check contacts and clean if necessary. 4 Insert remote. 5 Start system. 6 Contact your specialist dealer if the problem persists.
16-03, 16-04, 16-05, 16-06	Battery Theft Detection	<ol style="list-style-type: none"> 1 Restart system 2 Switch off system. 3 Remove battery from mount, check contacts and clean if necessary. 4 Insert the battery. 5 Start system. 6 Contact your specialist dealer if the problem persists.

Table 39: List of display screen error messages

Code	Description	Method of resolution
16-07	Speednode Theft Detection	<ol style="list-style-type: none"> 1 Restart system 2 Contact your specialist dealer if the problem persists.
16-08	Gear Shift Theft Detection	<ol style="list-style-type: none"> 1 Restart system 2 Contact your specialist dealer if the problem persists.
16-0A	Charger Theft Detection	<ol style="list-style-type: none"> 1 Restart system 2 Switch off system. 3 Disconnect charger from system and socket. 4 Wait until the status LED goes out. 5 Check plug contacts on pedelec and charger and clean if necessary. 6 Plug charger into the socket again. 7 Plug charger into the system again. 8 Start system. 9 Contact your specialist dealer if the problem persists.
16-0B	Lock Theft Detection	<ol style="list-style-type: none"> 1 Restart system 2 Contact your specialist dealer if the problem persists.
17-00	Remote Defective Component	<ol style="list-style-type: none"> 1 Re-start the system. 2 Contact your specialist dealer if the problem persists.
17-01	Motor Defective Component	<ol style="list-style-type: none"> 1 Restart system 2 Contact your specialist dealer if the problem persists.
17-02	Display Defective Component	<ol style="list-style-type: none"> 1 Restart system 2 Switch off system. 3 Remove on-board computer from mount, check contacts and clean if necessary. 4 Insert remote. 5 Start system. 6 Contact your specialist dealer if the problem persists.
17-03, 17-04, 17-05, 17-06	Battery Defective Component	<ol style="list-style-type: none"> 1 Restart system 2 Switch off system. 3 Remove battery from mount, check contacts and clean if necessary. 4 Insert the battery. 5 Start system. 6 Contact your specialist dealer if the problem persists.

Table 39: List of display screen error messages

Code	Description	Method of resolution
17-07	Speednode Defective Component	<ol style="list-style-type: none"> 1 Restart system 2 Contact your specialist dealer if the problem persists.
17-08	Gear Shift Defective Component	<ol style="list-style-type: none"> 1 Restart system 2 Contact your specialist dealer if the problem persists.
17-0A	Charger Defective Component	<ol style="list-style-type: none"> 1 Restart system 2 Switch off system. 3 Disconnect charger from system and socket. 4 Wait until the status LED goes out. 5 Check plug contacts on pedelec and charger and clean if necessary. 6 Plug charger into the socket again. 7 Plug charger into the system again. 8 Start system. 9 Contact your specialist dealer if the problem persists.
17-0B	Lock Defective Component	<ol style="list-style-type: none"> 1 Restart system 2 Contact your specialist dealer if the problem persists.
18-00	Remote Start Error	<ol style="list-style-type: none"> 1 Re-start the system. 2 Contact your specialist dealer if the problem persists.
18-01	Motor Start Error	<ol style="list-style-type: none"> 1 Restart system 2 Contact your specialist dealer if the problem persists.
18-02	Display Start Error	<ol style="list-style-type: none"> 1 Restart system 2 Switch off system. 3 Remove on-board computer from mount, check contacts and clean if necessary. 4 Insert remote. 5 Start system. 6 Contact your specialist dealer if the problem persists.
18-03, 18-04, 18-05, 18-06	Battery Start Error	<ol style="list-style-type: none"> 1 Restart system 2 Switch off system. 3 Remove battery from mount, check contacts and clean if necessary. 4 Insert the battery. 5 Start system. 6 Contact your specialist dealer if the problem persists.

Table 39: List of display screen error messages

Code	Description	Method of resolution
18-07	Speednode Start Error	<ol style="list-style-type: none"> 1 Restart system 2 Contact your specialist dealer if the problem persists.
18-08	Gear Shift Start Error	<ol style="list-style-type: none"> 1 Restart system 2 Contact your specialist dealer if the problem persists.
18-0A	Charger Start Error	<ol style="list-style-type: none"> 1 Restart system 2 Switch off system. 3 Disconnect charger from system and socket. 4 Wait until the status LED goes out. 5 Check plug contacts on pedelec and charger and clean if necessary. 6 Plug charger into the socket again. 7 Plug charger into the system again. 8 Start system. 9 Contact your specialist dealer if the problem persists.
18-0B	Lock Start Error	<ol style="list-style-type: none"> 1 Restart system 2 Contact your specialist dealer if the problem persists.
19-xx	Remote Safety Error	<ol style="list-style-type: none"> 1 Re-start the system. 2 Contact your specialist dealer if the problem persists.
1A-xx	Tampering detected	<ol style="list-style-type: none"> 1 Check that the magnet and speed sensor are correctly positioned. 2 Re-start the system. 3 Contact your specialist dealer if the problem persists.
1B-xx	System Voltage Error	<ol style="list-style-type: none"> 1 Check that the original battery has been inserted (36V/48V). 2 Re-start the system. 3 Contact your specialist dealer if the problem persists.
1C-xx	Bluetooth® Module Error	<ol style="list-style-type: none"> 1 Re-start the system. 2 Re-start FIT E-Bike Control (app); update if necessary. 3 Contact your specialist dealer if the problem persists.
1D-xx	EMS mode active	<ol style="list-style-type: none"> 1 Re-start the system. 2 Contact your specialist dealer if the problem persists.

Table 39: List of display screen error messages

Code	Description	Method of resolution
1E-xx	OEM mode active	<ol style="list-style-type: none"> 1 Re-start the system. 2 Contact your specialist dealer if the problem persists.
1F-xx	TEST mode active	<ol style="list-style-type: none"> 1 Re-start the system. 2 Contact your specialist dealer if the problem persists.
20-xx	Reserve mode active (info text)	<ol style="list-style-type: none"> 1 Charge the battery. 2 Contact your specialist dealer if the problem persists.
21-xx	Lock Error	<ol style="list-style-type: none"> 1 Re-start the system. 2 Contact your specialist dealer if the problem persists.
22-xx	Full load cycle active (info text)	<ul style="list-style-type: none"> ▶ Battery is charged 100% for calibration purposes despite Long Life mode.
23-xx	Pressure Sensor Error	<ul style="list-style-type: none"> ▶ Sensor may need to be replaced Contact specialist dealer.
29-xx	Display Communication Err.	<ol style="list-style-type: none"> 1 Re-start the system. 2 Contact your specialist dealer if the problem persists.
2A-xx	Display Software Error	<ol style="list-style-type: none"> 1 Restart system 2 Switch off system. 3 Remove on-board computer from mount, check contacts and clean if necessary. 4 Insert remote. 5 Start system. 6 Contact your specialist dealer if the problem persists.
2B-xx	Display Authentication Error	<ol style="list-style-type: none"> 1 Restart system 2 Switch off system. 3 Remove on-board computer from mount, check contacts and clean if necessary. 4 Insert remote. 5 Start system. 6 Contact your specialist dealer if the problem persists.
2C-xx	Display Peripheral Error	<ol style="list-style-type: none"> 1 Re-start the system. 2 Contact your specialist dealer if the problem persists.

Table 39: List of display screen error messages

Code	Description	Method of resolution
2D-xx	Display Identification Error	<ol style="list-style-type: none"> 1 Restart system 2 Switch off system. 3 Remove on-board computer from mount, check contacts and clean if necessary. 4 Insert remote. 5 Start system. 6 Contact your specialist dealer if the problem persists.
48-xx	Motor Communication Error	<ol style="list-style-type: none"> 1 Check plug contacts on the battery and pedelec; clean if necessary. 2 Contact your specialist dealer if the problem persists.
49-xx	Motor Unit Error	<ol style="list-style-type: none"> 1 Re-start the system. 2 Contact your specialist dealer if the problem persists.
4A-xx	Motor Overheat	<ol style="list-style-type: none"> 1 Switch off system. 2 Allow motor to cool and clean motor ventilation slots if necessary. 3 Switch on system.
4B-01, 4B-02	Motor Speed Sensor Error	<ol style="list-style-type: none"> 1 Re-start the system. 2 Contact your specialist dealer if the problem persists.
4C-01	Motor Torque Sensor Error	<ol style="list-style-type: none"> 1 Re-start the system. 2 Contact your specialist dealer if the problem persists.
4D-01	Motor Gear Error	<ol style="list-style-type: none"> 1 Re-start the system. 2 Contact your specialist dealer if the problem persists.
4E-xx	Motor Cadence Sensor Error	<ol style="list-style-type: none"> 1 Re-start the system. 2 Contact your specialist dealer if the problem persists.
4F-xx	Motor Software Error	<ol style="list-style-type: none"> 1 Re-start the system. 2 Contact your specialist dealer if the problem persists.
50-xx	Motor Current Error	<ol style="list-style-type: none"> 1 Re-start the system. ▶ Contact your specialist dealer if the problem persists.
51-xx	Motor Voltage Error	<ol style="list-style-type: none"> 1 Re-start the system. 2 Contact your specialist dealer if the problem persists.
52-xx	Motor Angled Sensor Error	<ol style="list-style-type: none"> 1 Re-start the system. 2 Contact your specialist dealer if the problem persists.

Table 39: List of display screen error messages

Code	Description	Method of resolution
53-xx	Motor Software Error	<ol style="list-style-type: none"> 1 Re-start the system. 2 Contact your specialist dealer if the problem persists.
67-01, 67-03, 67-05, 67-06, 67-11, 67-12, 67-15, 67-0A, 67-0B	Battery Voltage Error	<ol style="list-style-type: none"> 1 Re-start the system. 2 Contact your specialist dealer if the problem persists.
67-02, 67-07, 67-08, 67-09, 67-13	Battery Voltage Error	<ol style="list-style-type: none"> 1 Connect battery to the charger. 2 Re-start the system. 3 Contact your specialist dealer if the problem persists.
68-02, 68-03, 68-08, 68-13, 68-0A, 68-0B	Battery Charge/Disch. Error	<ol style="list-style-type: none"> 1 Disconnect battery charger. 2 Re-start the system. 3 Connect charger. 4 Start charging. 5 Contact your specialist dealer if the problem persists.
68-01, 68-04, 68-05, 68-06, 68-07, 68-08, 68-09, 68-11, 68-12, 68-13, 68-14, 68-16, 68-17, 68-18, 68-19, 68-1A, 68-0B	Battery Charge/Disch. Error	<ol style="list-style-type: none"> 1 Switch off system. 2 Remove the battery. 3 Insert the battery. 4 Start system. 5 Contact your specialist dealer if the problem persists.
69-01, 69-02, 69-08, 69-09	Battery Temperature Error (temperature too high)	<ol style="list-style-type: none"> 1 Switch off system. 2 Leave battery to cool down. 3 Switch on system. 4 Contact your specialist dealer if the problem persists.
69-03, 69-04, 69-06, 69-10, 69-0B, 69-0C, 69-0D	Battery Temperature Error (temperature too low)	<ol style="list-style-type: none"> 1 Allow battery to warm up slowly in warm environment. 2 Switch on system. 3 Contact your specialist dealer if the problem persists.
69-13	Battery Temperature Error	<ol style="list-style-type: none"> 1 Re-start the system. 2 Contact your specialist dealer if the problem persists.

Table 39: List of display screen error messages

Code	Description	Method of resolution
6A-xx	Battery Software Error	<ol style="list-style-type: none"> 1 Check whether the original battery has been inserted. 2 Check plug contacts on the battery and pedelec; clean if necessary. 3 Re-start the system. 4 Contact your specialist dealer if the problem persists.
6B-xx	Battery Hardware Error	<ol style="list-style-type: none"> 1 Re-start the system. 2 Contact your specialist dealer if the problem persists.
6C-xx	Battery Communication Error	<ol style="list-style-type: none"> 1 Check whether the original battery has been inserted. 2 Check plug contacts on the battery and pedelec; clean if necessary. 3 Re-start the system. 4 Contact your specialist dealer if the problem persists.
6D-xx	Battery Authentication Error	<ol style="list-style-type: none"> 1 Check whether the original battery has been inserted. 2 Check plug contacts on the battery and pedelec; clean if necessary. 3 Re-start the system. 4 Contact your specialist dealer if the problem persists.
6E-xx	Unknown Battery Error	<ol style="list-style-type: none"> 1 Check that correct battery has been inserted (36V/48V). 2 Check plug contacts for battery and pedelec; clean if necessary. 3 Carry out system restart. 4 Contact your specialist dealer if the problem persists.
FF-xx	Permanent Battery Error	<ol style="list-style-type: none"> 1 Re-start the system. 2 Contact your specialist dealer if the problem persists.
86-xx	Speednode Software Error	<ol style="list-style-type: none"> 1 Re-start the system. 2 Contact your specialist dealer if the problem persists.
87-xx	Speednode Authentication Error	<ol style="list-style-type: none"> 1 Re-start the system. 2 Contact your specialist dealer if the problem persists.

Table 39: List of display screen error messages

Code	Description	Method of resolution
95-xx	Charger Software Error	<ol style="list-style-type: none"> 1 Re-start the system. 2 Switch off system. 3 Disconnect charger from system and socket. 4 Wait until the status LED goes out. 5 Check plug contacts on pedevec and charger and clean if necessary. 6 Plug charger into the socket again. 7 Plug charger into the system again. 8 Start system. 9 Contact your specialist dealer if the problem persists.
96-xx	Charger Voltage Error	<ol style="list-style-type: none"> 1 Check that correct battery has been inserted (36V/ 48V). 2 Disconnect charger from system and socket. 3 Wait until the status LED goes out. 4 Check plug contacts on pedevec and charger and clean if necessary. 5 Plug charger into the socket again. 6 Plug charger into the system again. 7 Start system. 8 Contact your specialist dealer if the problem persists.
97-xx	Charger Current Error	<ol style="list-style-type: none"> 1 Check that correct battery has been inserted (36V/ 48V). 2 Disconnect charger from system and socket. 3 Wait until the status LED goes out. 4 Check plug contacts on pedevec and charger and clean if necessary. 5 Plug charger into the socket again. 6 Plug charger into the system again. 7 Start system. 8 Contact your specialist dealer if the problem persists.

Table 39: List of display screen error messages

Code	Description	Method of resolution
98-xx	Charger Temperature Error	<ol style="list-style-type: none"> 1 Disconnect battery charger. 2 Leave charger to cool down (> 30 minutes). 3 Plug charger into the socket again. 4 Plug charger into the system again. 5 Start system. 6 Contact your specialist dealer if the problem persists.
9A-xx	Lock Authentication Error	<ol style="list-style-type: none"> 1 Check that an original FIT lock is installed. 2 Re-start the system. 3 Contact your specialist dealer if the problem persists.
9B-xx	Lock blocked	<ol style="list-style-type: none"> 1 Re-start the system. 2 Check lock for dirt. 3 Contact your specialist dealer if the problem persists.
9C-xx	Lock Hardware Error	<ol style="list-style-type: none"> 1 Re-start the system. 2 Check lock for dirt. 3 Contact your specialist dealer if the problem persists.
9D-xx	Lock movement detected	<ol style="list-style-type: none"> 1 Re-start the system. 2 Check lock for dirt. 3 Contact your specialist dealer if the problem persists.

Table 39: List of display screen error messages

6.3.2 UltraCore battery

In the event of a hazard, a protective circuit switches the battery off automatically.

If a fault is detected in the battery, the LEDs flash on the **battery level indicator**.





Description	Method of resolution
<p>Code: </p> <p>Permanent error The battery has a permanent error.</p>	<p>1 Replace the battery.</p> <p>The battery is classified as having an unknown defect in this condition and must not be transported by mail or air.</p> <p>2 Contact specialist dealer.</p>
<p>Code: </p> <p>Charge error The battery has been overcharged and the charger may have a fault.</p>	<p>1 Contact specialist dealer.</p>
<p>Code: </p> <p>Current and cell errors There may be a fault in the motor or charger, or the battery may have gone into deep discharge.</p>	<p>1 Contact specialist dealer.</p>
<p>Code: </p> <p>Temperature error The battery is outside the permitted temperature range.</p>	<p>1 Allow battery to warm up slowly in warm environment or cool down in a cool environment.</p> <p>2 Switch on system.</p> <p>3 If flashing persists after the battery has not been used for a long time, it needs replacing.</p> <p>The battery is classified as having an unknown defect in this condition and must not be transported by mail or air.</p> <p>4 Contact specialist dealer.</p>

Table 40: List of battery error messages

Description	Method of resolution
<p>Code: </p> <p>Temperature error An authentication error may have occurred.</p>	<p>1 Check the battery connections for dirt and clean if necessary.</p> <p>2 Contact your specialist dealer if the problem persists.</p>

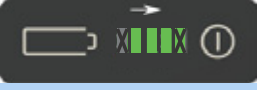
Table 40: List of battery error messages

6.3.3 Operating element

There is a status LED on the operating element in the navigation button.

Colour	Flash sequence	Status
GREEN	Lights up	1 Connect system to the maintenance tool at the specialist dealer's.
RED	Lights up	1 Re-start the system. 2 If the remote continues to light up red, have the component replaced at the specialist dealer's.
RED	Flashes	1 Re-start the system. 2 If the remote continues to light up red, have the component replaced at the specialist dealer's.

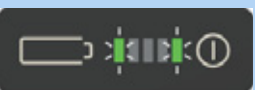
Table 41: Operating element status light

6.4 Instruction and customer service

The supplying specialist dealer will provide customer service. Contact details can be found on the pedecec pass for these operating instructions. The specialist dealer will explain all the pedecec functions to the new owner in person, this being when the specialist dealer hands over the pedecec at the latest. These operating instructions are provided with every pedecec, so that the rider can consult them at a later stage.

The supplying specialist dealer will also perform all inspection, modifications and repairs in the future.

6.5 Adjusting the pedecec



Crash caused by incorrectly adjusted torque

If a screw is fastened too tightly, it may break. If a screw is not fastened enough, it may loosen. This will cause a crash with injuries.

- ▶ Always observe the torque indicated on the screw and in the operating instructions.

Only a correctly adjusted pedecec will guarantee the desired ride comfort and health-promoting activity.

All settings must be re-configured if the body weight or maximum baggage weight changes.

6.5.1 Preparing

The following tools are required to adjust the pedecec:









	Tape measure
	Scales
	Spirit level
	Ring spanners 8 mm, 9 mm, 10 mm, 13 mm, 14 mm und 15 mm
	Torque wrench Working range 5... 40 Nm
	Hex key 2 mm, 2.5 mm, 3 mm, 4 mm, 5 mm, 6 mm and 8 mm
	Cross-recess screwdriver
	Slotted-head screwdriver

Table 42: Tools required for assembly

6.5.2 Pedelec adjustment procedure

- ▶ Determine rider's body weight.
- ▶ Determine weight of baggage.
- ▶ Determine riding habits: roads or off-road terrain

Sequence	Adjustment	Section	For pedelecs with components only				
			Rhomboid seat post	Ergonomic handles	Suspension fork	Rear frame damper	Headlight
1.1	Saddle	6.5.4.8					
1.2	Straighten saddle	6.5.4.10					
1.3	Adjust saddle height	6.5.4.12					
1.4	Adjust saddle position	6.5.4.13					
2	Adjust saddle tilt						
2	Handlebars	6.5.5					
3	Stem	6.5.6					
4	Handles	6.5.7		x			
5	Tyres	6.5.8					
6.1	Brake	6.5.9.1					
6.2	Position of the brake handles	6.5.9.2					
6.3	Brake handle tilt angle	6.5.9.3					
6.4	Determine grip distance	6.5.9.8					
6.5	Pressure point (optional)	6.5.9.6					
6.5	Retract the brake linings						
7	Gear shift	6.5.10					
8	Adjust suspension	6.5.12					
	- Adjust the suspension fork sag	6.6.13			x	x	
	- Adjust damper sag						
	- Adjust suspension fork rebound damper	6.5.13			x	x	
	- Adjust damper rebound damper	6.6.15					
	- Adjust damper compression adjuster	6.6.16				x	
10	Light	6.5.14					x
11	On-board computer	6.6.18					

Table 43: Procedure for pedelec adjustment

6.5.3 Riding position

The starting point for a comfortable posture is the correct position of the pelvis. If the pelvis is in the wrong position, it can cause different types of pain, e.g. in the shoulder or back.

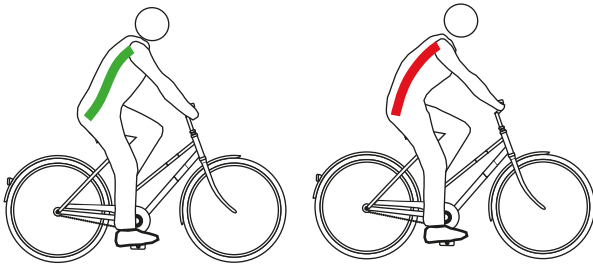

Figure 88: The pelvis is in the right position (green) or incorrect position (red)

The pelvis is in the right position if the spine forms an S-shape and a natural, easy arch.

The pelvis is positioned incorrectly if it tilts slightly backwards. As a result, the spine becomes curved and can no longer deflect to an optimal extent.

A suitable riding position must be selected beforehand depending on the pedelec type, physical fitness and desired trip distance or speed.

It is especially advisable to check and optimise the riding position once more before longer rides.

	Position on roadster	Position on city bike	Position on trekking bike	Position on sports bike
				
Angle of upper body (black dashed line)	Upright, almost vertical posture, back at an angle of almost 90°. Handlebars and handles are very close to the upper body.	Slightly inclined upper body, back at an angle of 60°...70°.	Sharply inclined upper body, back at an angle of 30°...60°. Greater distance between handlebars and saddle.	Greatly inclined upper body, back at an angle of 15°...30°. Saddle higher than the handlebars.
Upper arm-upper body angle (red line)	Extremely acute angle at around 20°. The upper arms are almost parallel to the upper body. The hands are simply placed loosely on the handlebars	An angle of 75°–80° is optimum. Many people prefer a smaller angle of up to 60° as it requires less effort to support the shoulders, arms and hands.	An angle of 90° is optimum. The muscular support required in the arms, back and shoulder girdle is reduced at 90°.	Above 90° Shoulders, arms and hands need to provide a great deal of support, the supporting muscles in the back are heavily strained and the load on the bearing surface shifts to the front.
Saddle-handlebar height difference [cm] (blue and green line)	>10 The handlebars are positioned far higher than the saddle.	10... 5 The handlebars are positioned higher than the saddle.	5... 0 Handlebars and saddle are almost at the same height.	< 0 The saddle is positioned far higher than the handlebars.
Benefits	The spine is intuitively moved into its natural S-shape. The strain on arms and hands is very slight – no effort required to support.	The upright position provides a good overview in traffic. Force can be applied to the pedals when pedalling without using much energy.	Shoulders, neck and hands provide more of the support effort, thus promoting a dynamic, agile riding style. Impact is reduced on the back, spine and buttocks, which is particularly important on longer rides. The whole body can apply force to the pedals effectively.	Optimum power transmission. Aerodynamic: low air resistance.
Disadvantages	Force is applied relatively inefficiently to the pedals. Weight rests exclusively on the buttocks. The spine slumps after a short time for many people (pelvic straightening).	The arms are often stretched through to the high handlebars – this leads to tense shoulders and painful hands. The spine tends to slump quickly due to the “high position”.	There is greater strain on the hands, neck and shoulders. The muscular system needs to be trained for this higher strain, i.e. riders should practise.	Requires highly trained muscles in back, legs, shoulders, abdomen! Comfortable riding position only for people who are fit.
Fitness level and use	Low fitness level, occasional cyclists	Medium fitness level, city cyclists	Medium to high fitness level, riding long distances	Speed-oriented, sports pedelec riding
Suitable pedelec types	City bike Folding bike	City bike Cargo bike	Trekking bike	Mountain bike Racing bicycle

Table 44: Overview of riding positions

6.5.4 Saddle

CAUTION

Sitting discomfort due to wrong saddle

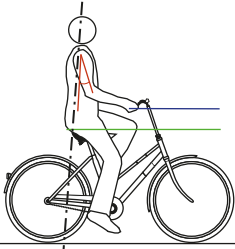
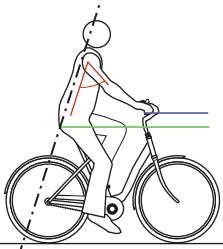
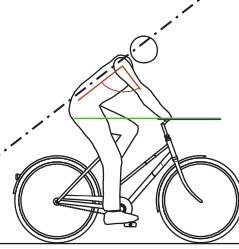
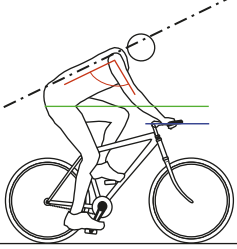
Around 50% of all pedelec riders experience discomfort due to incorrect sitting.

- ▶ Adjust the saddle (see Section 6.5.5).
- ▶ Check settings.
- ▶ If the saddle does not fit or causes pain, replace existing saddle with a large one which matches the sit bone distance.

6.5.4.1 Replacing the saddle

Not included in price



Saddles are components that may be replaced after approval by the vehicle or parts manufacturer. Replacing different sizes within a product series is permitted for saddles. Moreover, saddles may be exchanged if the rearward offset to the series or original range of use is not greater than 20 mm since a change in load distribution outside the intended adjustment range can lead to critical steering performance. The saddle shape plays a role here.

If the pre-mounted saddle is uncomfortable or causes pain, a saddle optimised to the rider's physique must be used. To do so:

- Determine the saddle shape (see Section 6.5.4.1)
- Establish the saddle width (see Section 6.5.4.2 or 6.5.4.3)
- Select the saddle hardness (see Section 6.5.4.5)
- Check the saddle.

6.5.4.2 Determining saddle shape

Ladies' saddle

The distance between the ischial tuberosities and the pubic symphysis is on average a quarter less in women than in men. This is why painful pressure points can occur on men's saddles through the saddle nose since saddles that are too narrow or too soft press on the genitals or coccyx



Figure 89: Female pelvis on saddles

For anatomical reasons, the pubic symphysis (front cartilage connection between the two halves of the pelvis) is, on average, a quarter lower than in the male pelvis. The angle between the pubic bones is wider.

The pelvis is more mobile in women than it is in men. Consequently, the pelvis often tilts forward more on the saddle. This causes high pressure in the genital area.

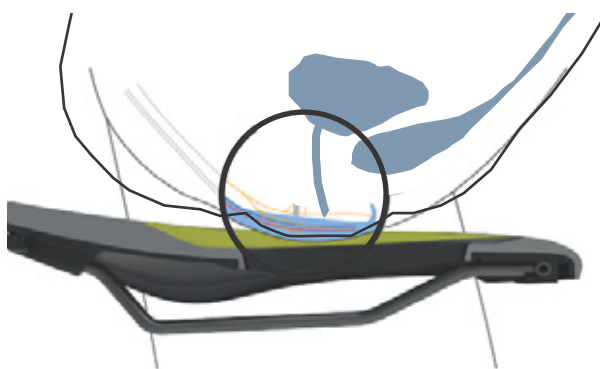

Figure 90: Pressure points on a saddle, female anatomy

To distribute the pressure optimally over the female bone structure in the seat area, a ladies' saddle should:

- have a relief opening far to the front
- have a wide V-shaped saddle edge.



Figure 91: Ergotec ladies' saddle

Men's saddle

In contrast to the female anatomy, men's pubic bones are at a much steeper angle to one another. The pubic symphysis is much higher.



Figure 92: Male pelvis on saddles

The male pelvis is less flexible than women's. Men sit more upright on the saddle and put greater strain on the sitting bones. This means that the transition area between the saddle rear and nose can be kept narrow (Y-shape). This gives more space to pedal.

Numbness when pedalling is often caused by high pressure in the sensitive perineal area. If the saddle is adjusted incorrectly, too narrow or too hard, the nose of the saddle presses directly onto the genitals. Blood circulation deteriorates.

The genitals on the outside are seldom the cause of discomfort since they can move out of the way and are not compressed by bone structures.

You should always consult a doctor if you have problems with the prostate. After a prostate

operation or inflammation, it is advisable to avoid any pressure in the perineal area and take a longer break from pedelec riding after consulting your doctor. A prostate saddle should then be used. This reduces the pressure in the perineal area by up to 100%.



Figure 93: Pressure points on a saddle, male anatomy

To distribute the pressure on the male bone structure in the seat area optimally, the saddle should:

- Shift the pressure to the sitting bones and parts of the pubic arches
- The perineal area must remain as free of pressure as possible

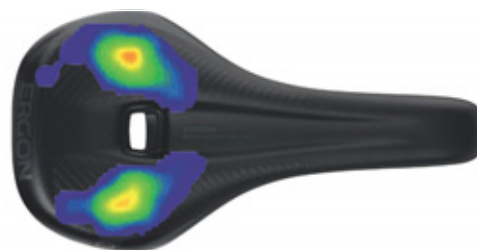

Figure 94: Ergotec men's saddle

6.5.4.3 Determining minimum saddle width with corrugated cardboard

- 1 Place corrugated cardboard on a flat, hard, unpadded seat.
- 2 Sit in the middle of the corrugated board.

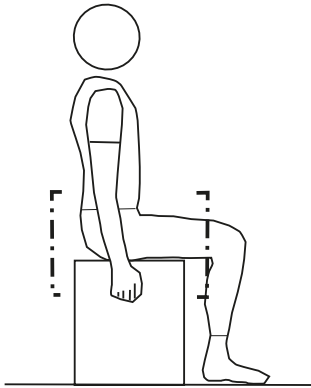

Figure 95: Sitting on the corrugated board

- 3 Pull the seat with your hands and arch your back.
 - ⇒ The sitting bones are more prominent and stand out more clearly on the corrugated cardboard.
- 4 Trace the outer edges of the two depressed areas in a circle.
- 5 Determine the centre of both circles and mark them with a dot.
- 6 Measure the distance between the two centres.

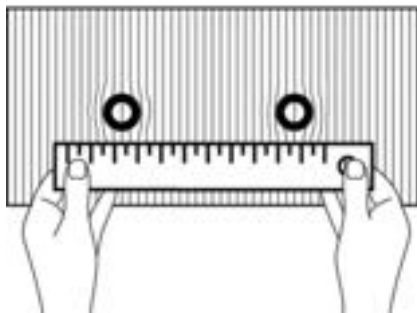

Figure 96: Measuring the distance

- ⇒ The distance between the two centre points is the sit bone distance and corresponds to the minimum saddle width.
- 7 Calculate saddle width (see Section 6.5.4.4).



6.5.4.4 Determining minimum saddle width with gel cushion

- 1 Smooth gel cushion.
- 2 Place gel cushion on a flat, hard, unpadded seat.
- 3 Sit in the middle of the gel cushion.

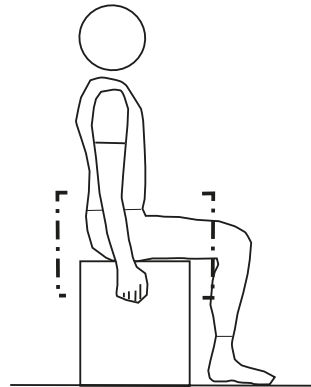

Figure 97: Sitting on the gel cushion

Pull the seat with your hands and arch your back.

- 4 The sitting bones are more prominent and stand out more clearly on the gel cushion.

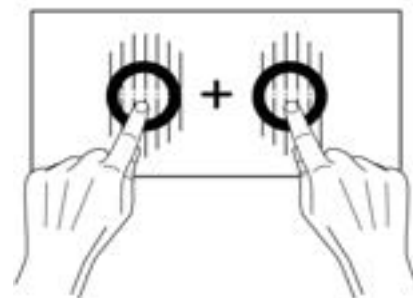

Figure 98: Adding the centres together

- 5 Determine the centres of both sitting bones.
- 6 Add the two values together.
 - ⇒ The total of the values is the sitting bone distance and corresponds to the minimum saddle width.
- 7 Calculate saddle width (see Section 6.5.4.4).

6.5.4.5 Calculating the saddle width

Depending on the position, the following value is added to the minimum saddle width.

Position on roadster	+ 4 cm
Position on city bike	+ 3 cm
Position on trekking bike	+ 2 cm
Position on sports bike	+ 1 cm
Triathlon/time trials	+ 0 cm

Table 45: Calculating the saddle width

6.5.4.6 Selecting the saddle hardness

Saddles are available in a wide range of hardnesses and must be adapted to the pedelec's use:

- A pedelec that is mainly used for commuting in jeans calls for a soft saddle.
- A pedelec that is mainly used for sporty riding with padded cycling shorts requires a hard saddle.

If the degree of hardness is not suitable, a new saddle must be selected.

6.5.4.7 Adjusting the saddle hardness

Only applies to pedelecs with this equipment

In air cushion saddles, the hardness of the saddle can be adjusted using the pump valve beneath the seat surface.

Soft	Pump 3 times
Medium	Pump 5 times
Hard	Pump 10 times

Table 46: VELO air cushion saddle settings

6.5.4.8 Straighten saddle

- ▶ Position saddle in direction of travel. In doing so, align the tip of the saddle with the top tube.



Figure 99: Positioning the saddle in direction of travel

6.5.4.9 Positioning the saddle with eightpins suspension seat post

Only applies to pedelecs with this equipment

- 1 Position saddle in direction of travel. In doing so, align the tip of the saddle with the top tube.
- 2 Use a torque wrench to tighten the seat post axle with 8 Nm.



Figure 100: Tightening the seat post axle

6.5.4.10 Adjusting the saddle height

- ✓ To adjust the saddle height safely, either:
 - Push the pedelec near to a wall so that the pedelec rider can lean on the wall to support themselves or
 - Ask another person to hold the pedelec.
- 1 Use the seat height formula to roughly set the saddle height:

$$\text{Seat height (SH)} = \text{inner leg length (I)} \times 0.9$$
- 2 Climb onto the bicycle.
- 3 Place your heel on the pedal and extend your leg, so that the pedal is at the lowest crank rotation point. Your knee should now be fully extended.

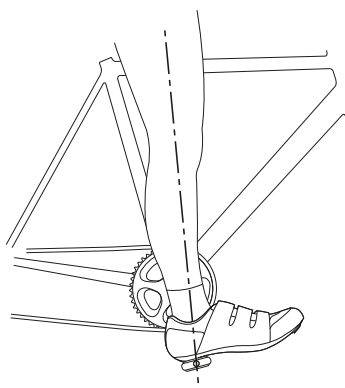

Figure 101: Heel method

- 4 Take a test ride.
 - ⇒ Pedelec riders sit straight on the saddle at an optimal saddle height.
 - If the pelvis moves to the left and right as you pedal, the saddle is too high.
 - If your knees are painful after a few kilometres, the saddle is too low.
- ⇒ Position the seat post according to needs if necessary. Adjust the seat height with the quick release.

- 5 Open the quick release on the seat post to change the seat height (1). To do so, push the clamping lever away from the seat post (3).

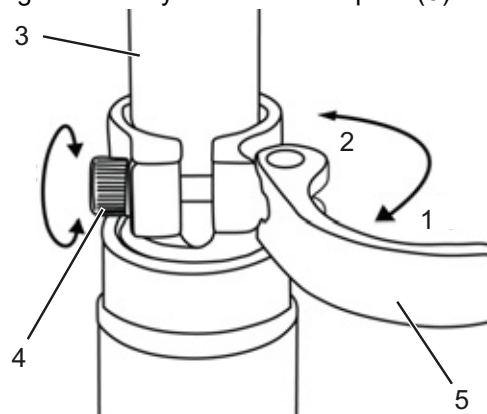

Figure 102: Opening the seat post quick release

- 6 Set the seat post to the required height.

CAUTION

Crash caused by an excessively high seat post setting

A *seat post* which is set too high will cause the *seat post* or the *frame* to break. This will cause a crash with injuries.

- ▶ Do not pull the seat post out of the frame beyond the minimum insertion depth marking.

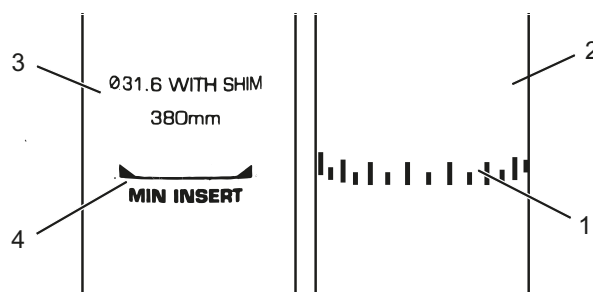

Figure 103: Detailed view of the seat post – examples of the minimum insertion depth marking

- 7 To close it, push the *seat post clamping lever* as far as it will go into the *seat post* (2).
- 8 Check the *clamping force* of the quick releases.

6.5.4.11 Setting the saddle height with the remote control

Use the seat height formula to set the saddle height:

Seat height (SH) = inner leg length (I) \times 0.9

Notice

If you are unable to achieve the required saddle height, the seat post must be lowered further into the seat tube. The seat post Bowden cable must be tightened in the frame up to the remote control to the same length as the seat post was lowered. If this is not possible, contact your specialist dealer.

Lowering the saddle

- 1 Sit on the saddle.
- 2 Press the remote control operating lever.
⇒ The seat post will lower.
- 3 Release the remote control operating lever when you have reached the desired height.

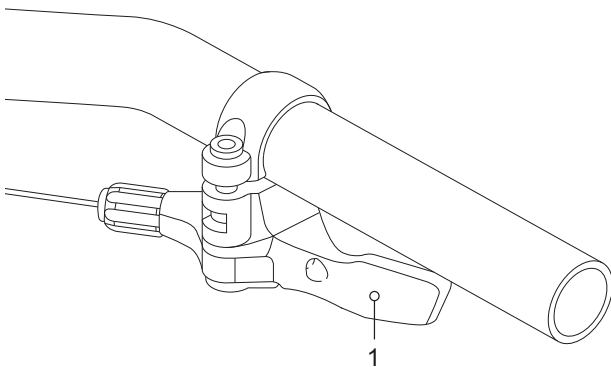

Figure 104: Remote control operating lever (1)

Raising the saddle

- 1 Remove any pressure from the saddle.
- 2 Press the remote control operating lever.
⇒ The seat post will rise.
- 3 Release the remote control operating lever when you have reached the desired height.

6.5.4.12 Adjusting the saddle position

The saddle can be shifted on the saddle frame. The right horizontal position ensures an optimal leverage position for legs. This prevents knee pain and painful incorrect pelvis positions. If you have displaced the saddle more than 10 mm, you need to adjust the saddle height again since both settings affect one another.

- ✓ The saddle setting must only be made when the bicycle is stationary.
- ✓ To adjust the saddle position either:
 - Push the pedelec near to a wall so that the pedelec rider can lean on the wall to support themselves or
 - Ask another person to hold the pedelec.
- ✓ Move the saddle within its permitted displacement range only (marked on the saddle stay).

1 Climb onto the pedelec.

2 Place the pedals into the vertical position with your feet.

⇒ Pedelec riders are adopting the optimal saddle position if the perpendicular line from the kneecap runs through the pedal axle.

- ▶ If the perpendicular line crosses behind the pedal, bring the saddle further forward.
- ▶ If the perpendicular line crosses in front of the pedal, bring the saddle further back.

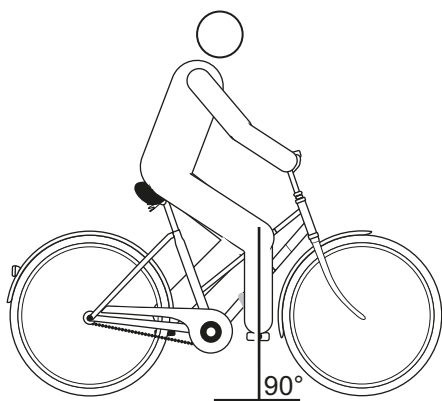

Figure 105: Knee cap perpendicular line

- 3 Unfasten and adjust the designated screw connections, and clamp them with the maximum tightening torque for the saddle clamping screws.

6.5.4.13 Adjusting the saddle tilt

The saddle tilt must be adjusted to the seat height, the saddle and handlebar position, and the saddle shape to ensure an optimum fit. The seating position can be optimised in this way if needed.

The saddle prevents pedelec riders from slipping backwards or forwards when placed in a horizontal position. This prevents seat problems. In any other position, the tip of the saddle may press uncomfortably into the crotch area. It is also recommended that the centre of the saddle is exactly straight. This ensures that the rider is seated with their sit bones on the wide rear part of the saddle.

1 Adjust the saddle tilt to horizontal.

2 Position saddle middle so that it is completely

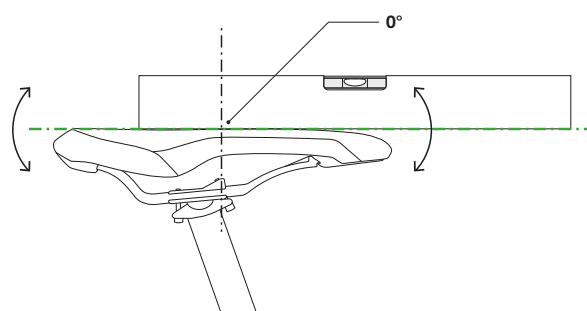

straight.

Figure 106: Horizontal saddle tilt with 0° tilt in the centre of the saddle

⇒ Pedelec riders sit comfortably on the saddle and do not slip backwards or forwards.

- 3 Pedelec riders tend to slip forwards on the narrow part of the saddle, adjust the riding position (see Section 6.6.2.3) or tilt the saddle very slightly backwards.

6.5.4.14 Checking saddle stability

- ▶ Check saddle stability after adjusting it (see Section 7.5.13).

6.5.5 Handlebars

6.5.5.1 Replace handlebars

Not included in price



Handlebars are components that may be replaced after approval by the vehicle or parts manufacturer. Handlebars may be replaced if the cable and/or line lengths do not need to be changed. A change in riding position is allowed within the original cable length. Furthermore, the load distribution on the pedelec changes considerably and may potentially lead to critical steering performance

- ▶ Check handlebar width and hand position.
- ▶ Have handlebars replaced at the specialist dealer's if necessary.

6.5.5.2 Adjusting the handlebar width

The handlebar width should be as wide as the rider's shoulders as a minimum. This is measured from mid-point to mid-point on the hand contact surfaces.

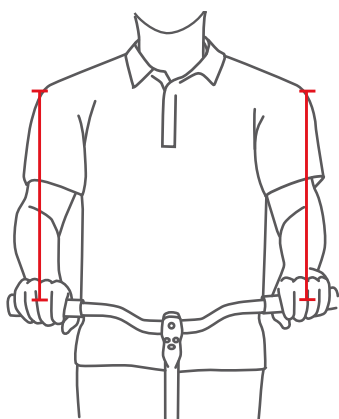

Figure 107: Determining the optimal handlebar width

The wider the handlebars are, the more control they provide, although wide handlebars require greater supporting force. Wider handlebars are particularly useful to ensure a safer ride for loaded touring bikes.

6.5.5.3 Adjusting the hand position

The hand is in an optimal position on the handlebars when the forearm and hand are in a straight line, i.e. the wrist is not bent. In this way, the nerves are not pinched and do not cause pain.

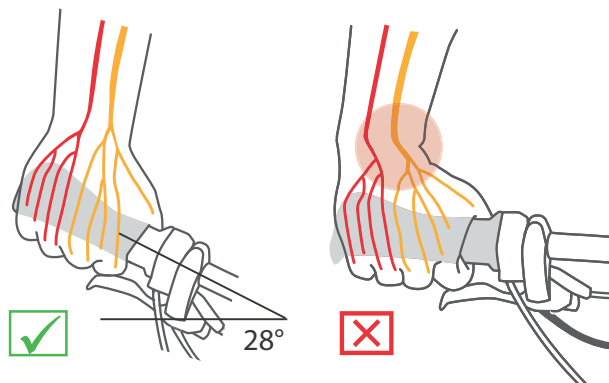

Figure 108: Distribution of nerves with curved and straight handlebars

The narrower the shoulders are, the greater the bend of the handlebars should be (maximum 28°).

Straight handlebars are advisable for sports bikes (e.g. MTB). They support direct steering behaviour, but lead to peaks in pressure and greater muscular strain on the arm and shoulder muscles.

6.5.5.4 Adjusting the handlebars

The handlebars and their position determine the posture that the pedelec rider adopts on the pedelec.

- 1 After selecting the riding position (see Section 6.6.2.1), determine the angle of the upper body and upper arm.
- 2 Pre-tension the back muscles when adjusting the handlebars. The only way to stabilise the spine and protect it from excessive strain is with the back and abdominal muscles pre-tensioned. Passive muscles are not able to perform this important task.
- 3 Set the required handlebar position by adjusting the stem height and angle (see Section 6.6.6).
- 4 After adjusting the handlebars, check the saddle height and riding position again. The position of the pelvis on the saddle may have changed when the handlebars were adjusted. This can have considerable impact on the position of the hip joint due to the pelvis tilting and may change the usable leg length on the saddle support by up to 3 cm.
- 5 Correct the saddle height and riding position if necessary.

6.5.6 Stem

6.5.6.1 Replacing the handlebars

Not included in price



Handlebar-stem units are components that may be replaced after approval by the vehicle or parts manufacturer. A stem must be replaced if cable and/or line lengths do not need to be changed. A change in riding position is allowed within the original cable length. Furthermore, the load distribution on the pedelec changes considerably and may potentially lead to critical steering performance

6.5.6.2 Adjusting the handlebar height with quick release

Only applies to pedelecs with this equipment

- 1 Open the stem clamping lever.

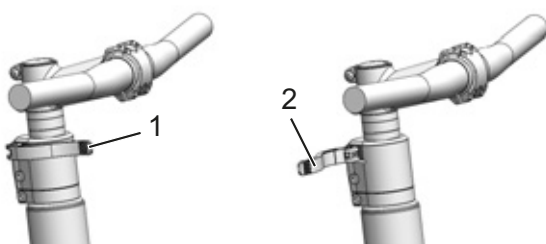

Figure 109: Open (2) and closed (1) stem clamping lever; All Up used as an example

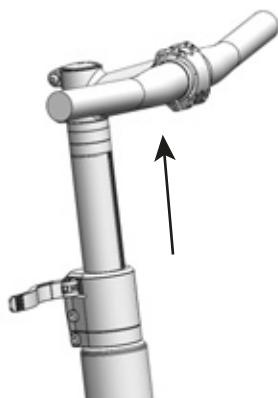

Figure 110: Pulling the locking lever upwards; All Up used as an example

- 2 Pull out the handlebars to the required height. Observe minimum insertion depth.
- 3 Close the stem clamping lever.

6.5.6.3 Checking the stem stability

- ▶ Hold handlebars firmly after adjusting the saddle. Press full body weight on the handlebars.
- ⇒ The handlebars remain stable in their position.

6.5.6.4 Adjusting the quick release clamping force



Crash caused by incorrectly set clamping force

Applying excessive clamping force damages the quick release. Insufficient clamping force will result in unfavourable transmission of force. This can cause components to break. This will cause a crash with injuries.

- ▶ Never fasten a quick release using a tool (e.g. hammer or pliers).

If the *handlebar clamping lever* stops before reaching its end position, unscrew the *knurled nut*.

- ▶ Tighten the *knurled nut* on the seat post if the *seat post clamping lever's* clamping force is not effective enough.
- ▶ Contact your specialist dealer if the clamping force cannot be set.

6.5.6.5 Setting the quill stem

Only applies to pedelecs with this equipment

In the case of a quill stem, the stem and fork steerer form a permanently interconnected component, which is clamped in the fork steerer. The stem and shaft must be replaced together.

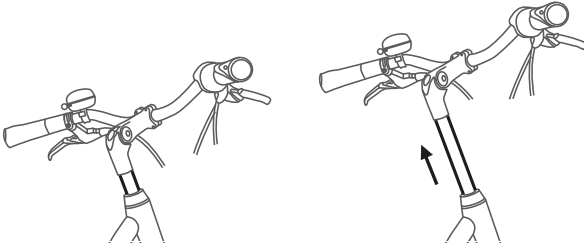

Figure 111: Adjusting the quill stem height

- 1 Undo screw.
- 2 Pull quill stem out.
- 3 Tighten screw.

6.5.6.6 Adjusting the Ahead stem

Only applies to pedelecs with this equipment

In the case of an Ahead stem, the stem is placed directly on the fork steerer, which protrudes over the frame.

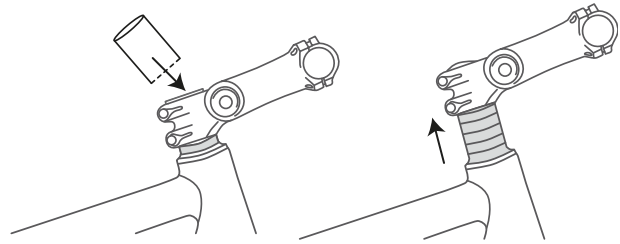

Figure 112: Raising the Ahead stem by fitting spacer rings

The handlebar height is adjusted once during production using spacer rings. The part of the fork steerer protruding is then cut off. The handlebar stem can then no longer be set higher, but only slightly lower.

6.5.6.7 Adjusting the angle-adjustable stem

Only applies to pedelecs with this equipment

Angle-adjustable stems are available in different lengths for quill and Ahead stems.

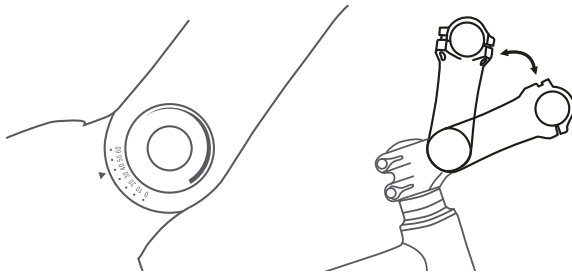

Figure 113: Different versions of angle-adjustable stems

Adjusting the stem angle (c) changes both the distance from the upper body to the handlebars (b) and the handlebar height (a).



Figure 114: City bike (blue) and trekking bike position (red) by changing the angle

6.5.7 Handles

6.5.7.1 Replacing the handles

Not included in price



Handles with bolt clamps are components which may be replaced without approval.

If there is pain or numbness in the index, middle finger or thumb, this may be due to excessive pressure on the exit of the carpal tunnel. On longer rides, this can increasingly cause hand fatigue and make it more and more difficult to maintain a correct hand position.

In the case of ergonomically shaped handles, the palm rests on the anatomically shaped handle. A greater contact surface means that the pressure is more evenly distributed. Nerves and vessels are no longer squeezed in the carpal tunnel.

Moreover, the hand is supported and held in the correct position so that the hand can no longer bend.

If the pre-mounted handles are uncomfortable or cause pain or numbness in the index, middle finger or thumb, ergonomic handles, bar ends or multi-position handlebars should be used.

6.5.7.2 Adjusting ergonomic handles

Only applies to pedelecs with this equipment

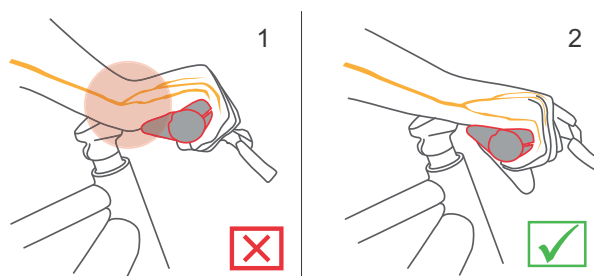

Figure 115: Incorrect (1) and correct (2) position of the handle.



- 1 Undo handle clamping screw.
 - 2 Turn handle into the right position.
 - 3 Fasten handle clamping screw with the torque value indicated there.
- ⇒ The handles are firmly fastened.
- ⇒ The pull-off force of the handles is at least 100 N in the roadster, city and trekking positions, and at least 200 N in the sporty position.

6.5.7.3 Checking handlebar stability

► See Section [7.5.12](#).

6.5.8 Tyres

6.5.8.1 Adjust tyre pressure

The correct tyre pressure largely depends on the weight load on the tyres. This load is determined by the weight of the pedelec, the rider's body weight and the luggage load.

Unlike cars, the weight of the vehicle has little impact on the total weight. Moreover, the personal preferences for low rolling resistance or a high degree of suspension comfort vary a great deal.

It is important to remember that

- the higher the tyre pressure is, the lower the wear, rolling resistance and the risk of breakdown are.
- The lower the pressure in the tyre is, the greater the comfort and grip that the tyre offers is.

In the case of pedelecs used on the road, the rule is the greater the tyre pressure is, the lower the tyre rolling resistance is. The risk of breakdown is also lower when the pressure is high. A permanently excessively low tyre pressure often leads to premature wear in the tyre. Cracking in the side wall is a typical consequence of very low tyre pressure. Abrasion is also unnecessarily high.

On the other hand, a tyre can absorb road impacts more effectively at a low pressure.

As a general rule, wide tyres are operated at a lower tyre pressure. They provide the option of exploiting the advantages of the lower tyre pressure without the serious disadvantages it causes with regard to wear, rolling resistance and breakdown protection.

- ✓ Never exceed or go below the minimum and maximum pressure limits indicated on the tyre.

1 Pump the tyre to the recommend tyre pressure.

Tyre width	Tyre pressure in bar for body weight		
	approx. 60 kg	approx. 80 kg	approx. 110 kg
25 mm	6.0	7.0	8.0
28 mm	5.5	6.5	7.5
32 mm	4.5	5.5	6.5
37 mm	4.0	5.0	6.0
40 mm	3.5	4.5	6.0
47 mm	3.0	4.0	5.0
50 mm	2.5	4.0	5.0
55 mm	2.0	3.0	4.0
60 mm	2.0	3.0	4.0

Table 47: SCHWALBE recommend tyre pressure

2 Perform a visual check on tyres.



Figure 116: Correct tyre pressure. The tyre is barely deformed under the load of the body weight



Figure 117: Much too little tyre pressure

6.5.8.2 Replacing tyres

Not included in price



Tyres are components that may be replaced after approval by the vehicle or parts manufacturer.

Different tyres need to be used when the area of use is changed, more weight or greater puncture protection is added, and greater acceleration or more dynamic cornering is used.

Tyres may be replaced if

- They are approved for use on e-bikes
- They comply with ETRTO dimensions
- They have the same load capacity as a minimum
- They have a comparable level of puncture protection as a minimum

6.5.9 Brake

The handbrake grip distance can be adjusted to ensure that it can be reached more easily. The pressure point can also be adjusted to the pedelec rider's preferences.

6.5.9.1 Change handbrake position

Having the brake handle in the correct position prevents the rider from stretching their wrist too far. Moreover, the brake can also be operated without any discomfort and without changing the handle position or releasing the handle.

- ✓ Apply handbrake with the third finger phalanx in bursts to brake gently.
 - ✓ The setting for the middle finger is used for pedelec riders who brake with their middle finger or with two fingers.
- 1 Position your hand on the handle in such a way that the outer heel of the hand is flush with the end of the handlebar.
 - 2 Extend the index finger (about 15°).

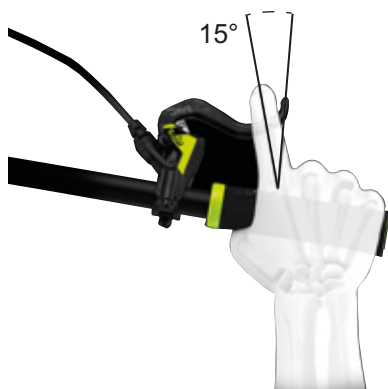

Figure 118: Brake handle position

- 3 Push handbrake outwards until the third finger phalanx sits in the recessed grip.

6.5.9.2 Change handbrake inclination angle

The nerves that pass through the carpal tunnel are connected to the thumb and the index and middle fingers. An excessively steep or excessively flat brake angle will cause the wrist to bend, thus narrowing the carpal tunnel. This can cause numbness and tingling in the thumb and index and middle fingers.

- 1 Calculate the difference between the height of the handlebars and the saddle height to determine the saddle-handlebar height difference.

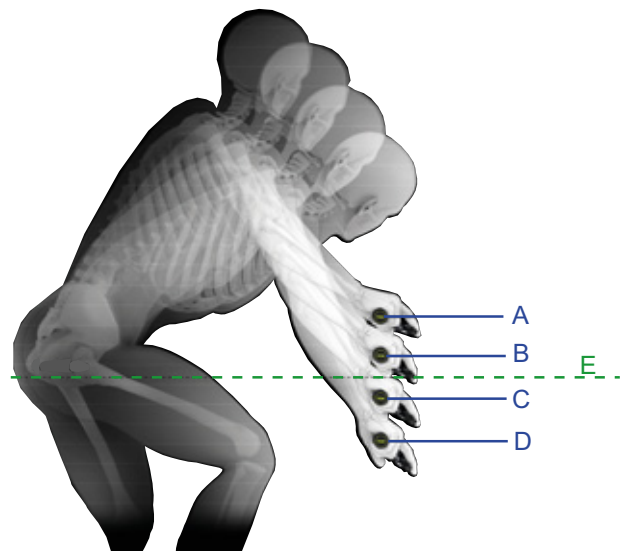

Figure 119: Example of 4 different handlebar heights (A, B, C and D) and the saddle height (E)

Calculation	Saddle-handlebar height difference [mm]
A – E	>10
B – E	0... +10
C – E	0... -10
D – E	< -10

Table 48: Examples of saddle-handlebar height difference

Adjust the angle of the handbrake so that it forms a natural extension of the forearm.

- 2 Set the brake lever angle as indicated in the table.

Saddle-handlebar height difference (mm)	Brake angle
>10	20°...25°
0... 10	25°...30°
0... -10	30°...35°
< -10	35°...45°

Figure 120: Brake angle

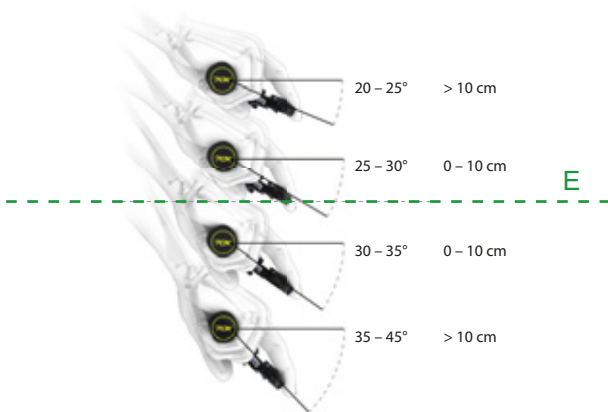

6.5.9.3 Determining the grip distance

- 1 Measure hand size using the grip distance gauge.
- 2 Adjust the grip distance at the pressure point based on the hand size.



Figure 121: Handbrake positioning

Hand size	Grip distance (cm)
S	2
M	3
L	4

6.5.9.4 Grip distance on a SHIMANO ST-EF41 handbrake

Only applies to pedelecs with handbrakes:

BL-M4100
BL-M7100
BL-M8100
BL-MT200
BL-MT201
BL-MT400
BL-MT401
BL-MT402
BL-T6000
GRX ST-RX600
M7100
M8100
RS785

The handbrake position can be adjusted to the pedelec riders' requirements.

► Contact specialist dealer.

6.5.9.5 Replacing brakes

Not included in price



Brake components may only be replaced with original components.

In the case of disc brake pads, the optimum pad compound may be adapted to the surface and the rider's experience.

6.5.9.6 Retracting the brake linings

Disc brakes require wearing-in time. The braking force increases over time. The braking force is increased during break-in time. This is also the case when the brake pads or brake discs are replaced.

- 1 Accelerate pedelec to 25 km/h.
 - 2 Brake pedelec until it comes to a halt.
 - 3 Repeat process 30 to 50 times.
- ⇒ The disc brake is retracted and provides optimal braking power.

6.5.10 Gear shift

Adjust the position of the gear shift to the pedelec riders' needs.

- 1 Undo attachment screw.
- 2 Place control panel or shifter into the position where the pedelec rider can use the control panel or the shifter with their thumb and/or index finger. The shifter must never block the handbrake.
- 3 Tighten attachment screw.



6.5.10.1 Replacing the gear shift

Not included in price

All gear shift components (rear derailleur, shifter, twist grip, shift cables and sleeves) may be replaced provided that:

- All gear shift components are suitable for the number of gears
- All gear shift components are compatible with one another

It is permitted to change from an electronic gear shift variant to a mechanical one.

It is prohibited to change from a mechanical gear shift variant to an electronic one.

6.5.10.2 Adjusting the SHIMANO shifter

Only applies to pedelecs with this equipment

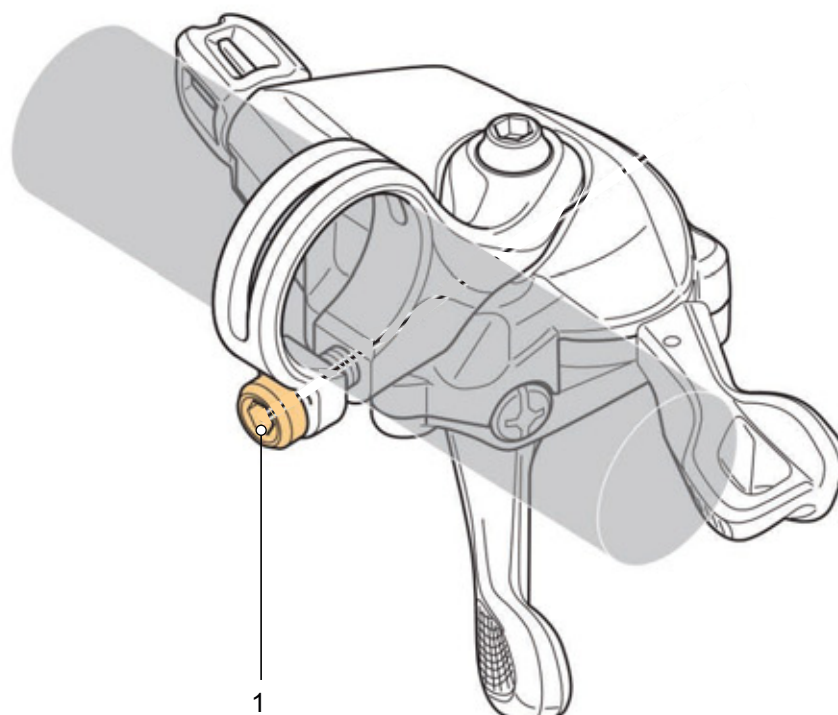

Figure 122: Position of attachment screw in SHIMANO shifter (1)

6.5.11 Suspension



All suspension components (rigid and suspension forks and rear frame dampers) are parts which may be replaced after approval by the vehicle or part manufacturer.

A pedelec's fork suspension and rear frame damper suspension can be adjusted to the rider's weight in up to six increments, depending on the suspension system.

► Follow the correct order for adjustment.

Sequence	Adjustment	Section	For pedelecs with components only	
			Suspension fork	Rear frame damper
1	Adjust the suspension fork sag	6.5.12	x	
2	Adjust the rear frame damper sag			x
3	Adjust suspension fork rebound damper	6.5.13	x	
4	Adjust rear frame damper rebound damper			x
5	Adjust the rear frame damper compression adjuster			x
6	The fork compression adjuster is adjusted to the terrain while riding.	6.20		

Table 49: Order for adjusting the suspension

6.5.12 Fork sag



Crash caused by incorrectly set suspension

If the suspension is set incorrectly, the fork may become damaged, meaning problems may occur when steering. This will cause a crash with injuries.

- Never ride without air in the air suspension fork.
- Only use the pedelec if the suspension fork is adjusted to the rider's body weight.

Adjustments on the chassis change ride performance significantly. The rider needs to get used to the pedelec and break it in to prevent accidents.

The sag depends on the position and body weight and should be between 10% and 30% of the maximum fork deflection, depending on preferences and on how the pedelec is used.

Greater sag (20% to 30%)

A greater sag increases sensitivity to bumps, thus producing greater suspension motion. A greater sensitivity to bumps ensures more comfortable ride performance and is used on pedelecs with a longer deflection.

Decreased sag (10% to 20%)

A decreased sag reduces sensitivity to bumps, thus producing less suspension motion. A lower sensitivity to bumps ensures a firmer, more efficient ride performance and is generally used on pedelecs with a shorter deflection.

The adjustment shown here represents a basic setting. Pedelec riders should change the basic setting to suit the surface and their preferences.

It is advisable to make a note of the basic settings. These can then be used as a starting point for subsequent settings and as a safeguard against unintentional changes.

6.5.12.1 Adjusting the SR SUNTOUR fork steel suspension

Only applies to pedelecs with this equipment

- 1 You will find the **sag setting wheel (1)** beneath the plastic cover on the crown. Remove the plastic cover.

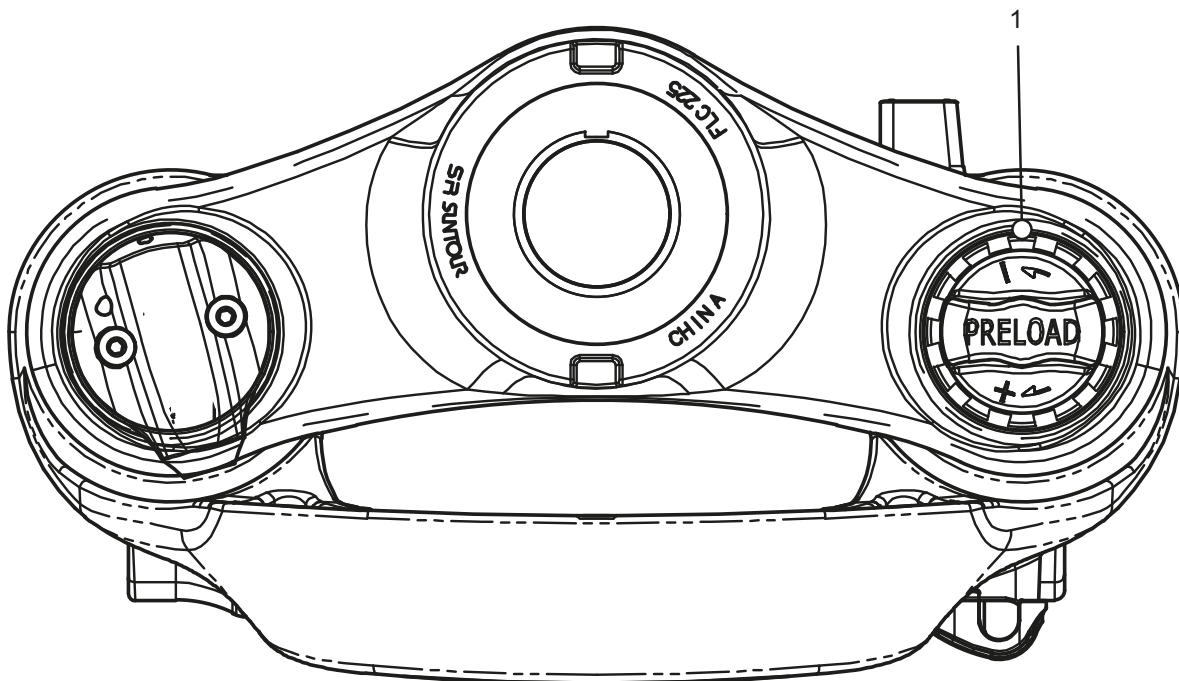

Figure 123: Sag setting wheel (1) on the suspension fork crown

- ▶ Turn the **sag setting wheel** clockwise to increase the spring pre-tensioning.
 - ▶ Turn the **sag setting wheel** anti-clockwise to decrease the spring pre-tensioning.
- ⇒ You will have made the ideal setting when the shock absorber deflects 3 mm when subject to body weight.
- 3 Replace the plastic cover on the crown after making the setting.

6.5.12.2 Adjusting the SR SUNTOUR fork air suspension

Only applies to pedelecs with this equipment

- The **air valve** is located beneath the **air valve cap** on the crown. Twist off the **air valve cap**.



Figure 124: Different screw caps

- 1 Attach a high-pressure damper pump to the **air valve**.
- 2 Pump air suspension fork to the required pressure. Observe the levels in the SR SUNTOUR tyre pressure table. Never exceed the recommended maximum tyre pressure.

Recommended air pressure (psi)						
Body weight	AION35 Mobie 45	Axon34 XCR34 XCR32	Mobie 45	NCX	XCR24	XCM-Jr.
<55 kg	35... 50	40... 55	40... 55	40... 55	40... 55	40... 55
55 ... 65 kg	50... 60	55... 65	55... 65	55... 65	–	–
65 ... 75 kg	60... 70	65... 75	65... 75	65... 75	–	–
85 ... 95 kg	85... 100	85... 100	85... 100	85... 95	–	–
> 100 kg	+105	+100	+100	+100	–	–
Maximum air pressure	120	145	130	180	100	100

Table 50: SR SUNTOUR tyre pressure table for the air fork

- 3 Detach high-pressure damper pump.
- 4 Measure the distance between the crown and the dust seal. This distance is total deflection of the fork.
- 5 Push a cable tie attached temporarily downwards against the dust seal.
- 6 Put on normal pedelec clothing (including baggage).
- 7 Sit on the pedelec in your usual riding position and support yourself against an object, such as a wall or tree.
- 8 Get off the pedelec without allowing it to deflect.
- 9 Measure distance between the dust seal and the cable tie.
 - ⇒ This measurement is the sag. The recommended value is between 15% (hard) and 30% (soft) of the total fork deflection.
- 10 Increase or reduce air pressure until you have reached the desired sag.
- 11 If the sag is correct, turn the **air valve cap** clockwise.
- 12 If you are unable to achieve the required sag, an internal adjustment may be needed. Contact specialist dealer.

6.5.13 Fork rebound damping

Only applies to pedelecs with this equipment

Rebound damping in the suspension fork and the rear frame damper determines the speed at which the rear frame damper rebounds after being subjected to load. Rebound damping controls the suspension fork extension and rebound speed, which, in turn, has an impact on traction and control.

Rebound damping can be adjusted to body weight, spring stiffness, deflection, the terrain and the pedelec rider's preferences.

If the air pressure or spring stiffness increases, the extension and rebound speeds also increase.

Rebound damping needs to be increased to achieve an optimal setting if the air pressure or spring stiffness is increased.

The damper rebounds at a controlled speed if the fork is optimally adjusted. The wheel stays in contact with the ground when passing over bumps (blue line).

The fork head, handlebars and body follow terrain (green line) when riding over bumps. The suspension motion is predictable and controlled.

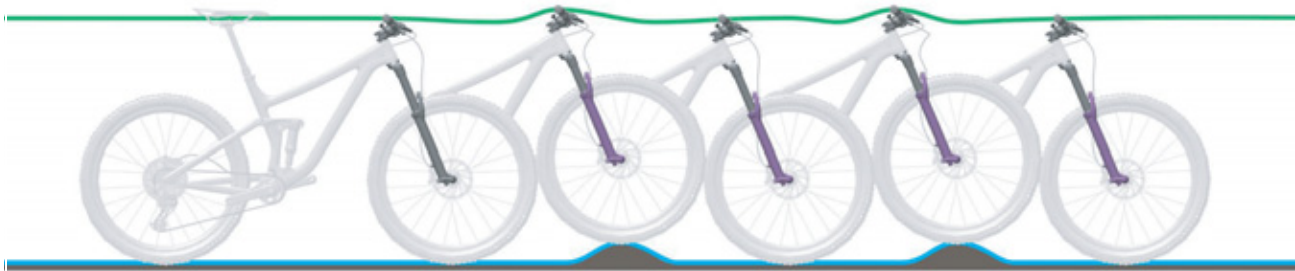
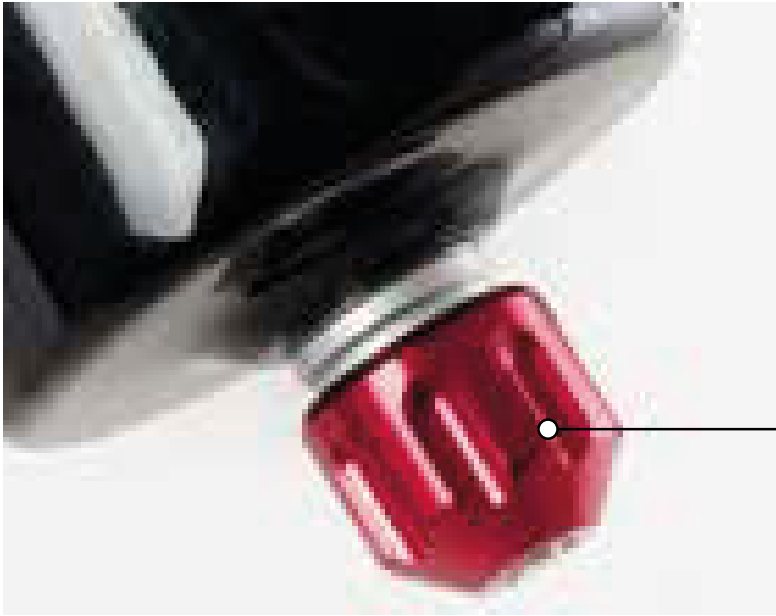

Figure 125: Optimum fork ride performance

6.5.13.1 Adjusting the SR SUNTOUR fork rebound damping

Only applies to pedelecs with this equipment



1

Figure 126: Example of SR SUNTOUR rebound screw (1)

- ✓ The fork sag is adjusted.
 - 1 Turn the rebound screw in a clockwise direction towards the closed position until it stops.
 - 2 Turn the **rebound screw** slightly in an anti-clockwise direction.
- ⇒ Adjust the rebound damper in such a way that the fork rebounds quickly, but without bottoming out upward. Bottoming out refers to when the fork rebounds too quickly and stops moving abruptly once it has reached the full rebound distance. You can hear and feel a slight impact when this happens.

6.5.14 Riding light

Example 1

If the headlight is positioned too high, oncoming traffic will be dazzled. This can cause a serious accident with fatalities.

Example 2

Positioning the headlight correctly can ensure that oncoming traffic is not dazzled and no-one is put at risk.

Example 3

If the headlight is positioned too low, the space ahead is not illuminated to an optimum extent and the rider's vision is reduced in the dark.

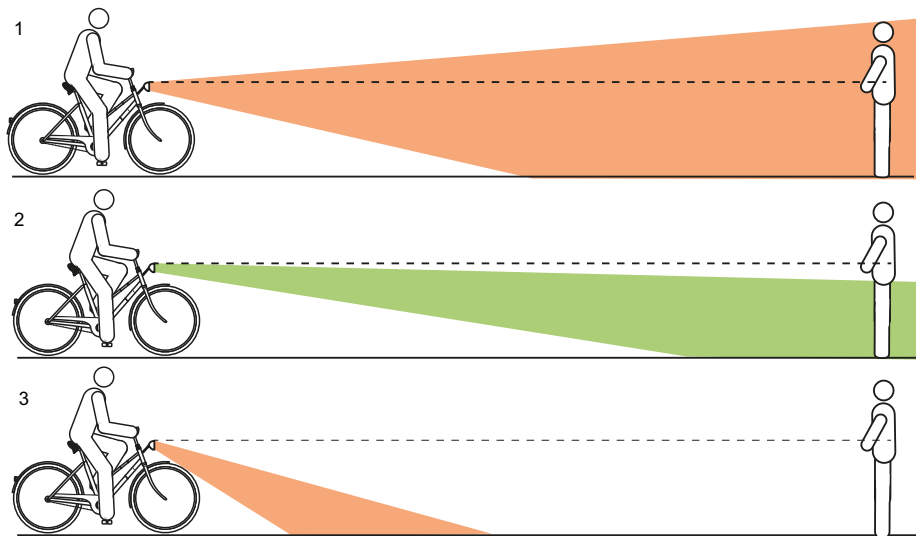

Figure 127: Light positioned too high (1), correctly (2) and too low (3)

6.5.14.1 Adjusting the headlight

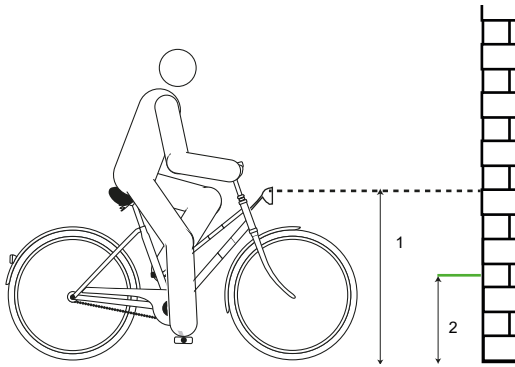

Figure 128: Measuring on the wall

- 1 Position the pedelec so that its front is facing a wall.
- 2 Mark the height of the headlight (1) on the wall with chalk.
- 3 Mark half the height of the headlight (2) on the wall with chalk.

- 4 Place pedelec 5 m in front of the wall.
- 5 Stand the pedelec up straight.

- 6 Hold the handlebars straight with both hands. Do not use the kickstand.
- 7 Switch on riding light.

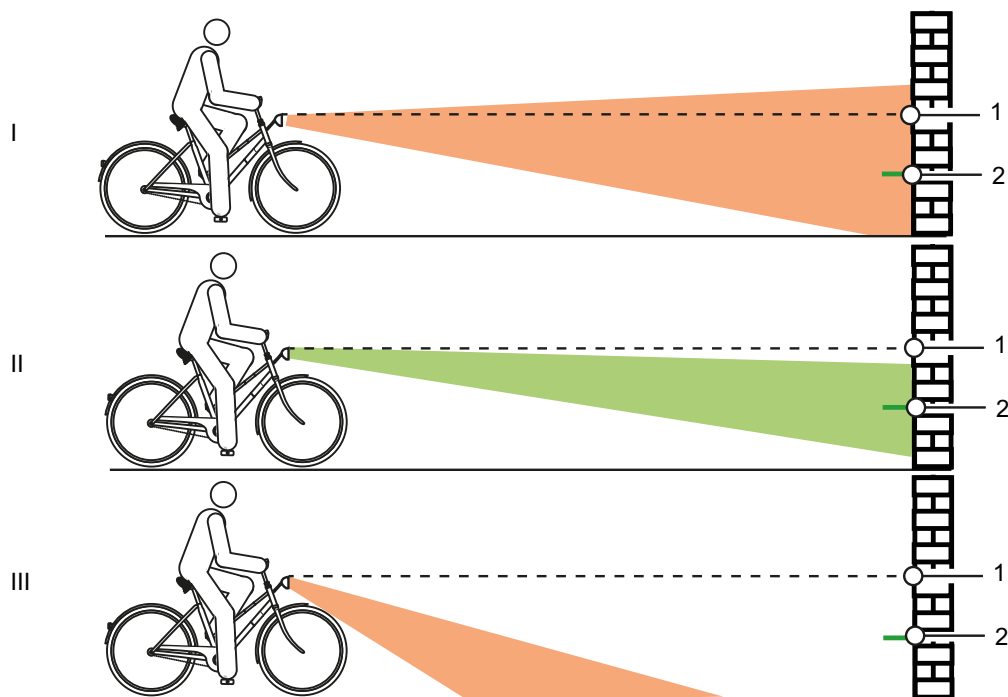

Figure 129: Light positioned too high (1), correctly (2) and too low (3)

- 8 Check the position of the light beam.
 - ▶ (I) if the upper edge of the light beam is above the headlight height mark (1), the riding light will dazzle. The headlight must be positioned lower.
 - ▶ If the mid-point of the light beam is on or slightly below the mark showing half the height of the headlight (2), the lighting is optimally positioned.
 - ▶ If the light beam is in front of the wall, move the headlight up.

6.5.15 On-board computer

CAUTION

Crash caused by distraction

A lack of concentration while riding increases the risk of an accident. This may cause a crash with serious injuries.

- ▶ Never allow yourself to be distracted by the on-board computer.
- ▶ Stop pedelec if you want to make inputs on the on-board computer other than change the level of assistance. Only enter data when the bicycle is stationary.

Notice

- ▶ Do not use on-board computer as a handle. The on-board computer may become irreparably damaged if you use it to lift the pedelec.

6.5.15.1 Switching on the on-board computer

- ✓ A sufficiently charged battery has been inserted into the pedelec.
- ✓ The battery is firmly in place. The key has been removed.
- ▶ Press **On-Off button (on-board computer)** at least one second.
- ⇒ The system starts. The Drive main menu is displayed.



Figure 130: Display (1) on the FIT Remote with LCD

6.5.15.2 Operating the display

The display is operated using six buttons on the control panel.



Figure 131: Display (1) on the FIT Remote with LCD

The rider can press the **Selector button** (2)

- to the left or right to access the different main screens and
- press to view the sub-screens.

The rider can use the **plus key** (3) and **minus key** (4)

- to access the sub-levels and
- scroll up and down a list.

6.5.15.3 SELECTION MENU

Use the **selector button** (2) to switch menus.

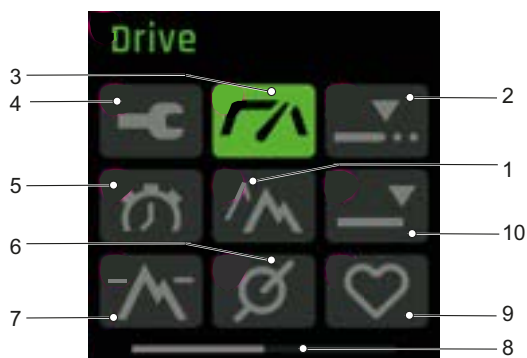

Figure 132: Selection menu, page 1

- 1 TRIP HEIGHT MENU (see Section 3.4.2.6)
- 2 TRIP DISTANCE MENU (see Section 3.4.2.4)
- 3 DRIVE MAIN MENU (see Section 3.4.2.2)
- 4 SETTINGS MENU
- 5 TRIP TIME MENU (see Section 3.4.2.5)
- 6 CADENCE MENU (see Section 3.4.2.9)
- 7 HEIGHT MENU (see Section 3.4.2.8)
- 8 Guidance bar
- 9 PULSE MENU
- 10 HEIGHT MENU (see Section 3.4.2.7)

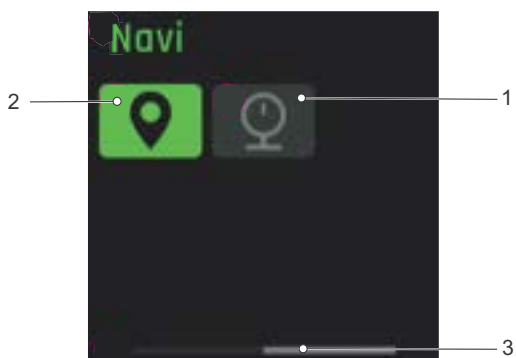

Figure 133: Selection menu, page 2

- 1 PRESSURE MENU
- 2 NAVI MENU
- 3 Guidance bar

6.5.15.4 Changing the settings

- ✓ The pedelec is stationary. You cannot open and adjust the SETTINGS MENU while riding.
- ✓ The display is inserted and shows the SELECTION MENU.
- ▶ Press the **Selector button** until the last page of the SETTINGS MENU is displayed.

All system and service-relevant values can be read and changed in the settings. The settings menu can change if components or services are added.

Menu	Submenu
Resetting the values	
	→ <Trip Reset>
	→ <Factory Settings>
Default settings	
	→ <Language>
	→ <Time>
	→ <Date>
	→ <Units>
	→ <Time Format>
Connectivity	
	→ <Connect Komoot>
	→ <Connect Heart Rate Sensor>
My Bike	
	→ <Assistance>
	→ <Calibration Altitude>
	→ <Auto Backlight>
	→ <Auto Power Off>
	→ <Vibration feedback>
Charging	
	→ <Normal Charge>
	→ <Fast Charge>
	→ <Charge to Storage>
	→ <LONG-LIFE mode>
Errors	
About	

Table 51: Basic structure of FIT menu and sub-menu

6.5.15.5 Setting the language

The menus can be set to the required language.

- 1 Open the SETTINGS MENU.
 - 2 Open <Localization><Language>.
 - 3 Follow the instructions on the display.
- ⇒ All menus are now displayed in the selected language.

6.5.15.6 Adjusting the clock

The clock can be adjusted.

- 1 Open the SETTINGS MENU.
 - 2 Open <Localization><Time>.
 - 3 Press the **plus key** and **minus key** to set the current time in minutes and hours.
 - 4 Press the **Selector button**.
- ⇒ You now exit the menu. The time you entered is now saved.
- ▶ Press CANCEL on the display screen if you do not wish to adjust the clock.
- ⇒ You now exit the menu. The time you entered will not be saved.

6.5.15.7 Setting the date

The date can be adjusted.

- 1 Open the SETTINGS MENU.
 - 2 Open <Localization><Date>.
 - 3 Press the **plus key** and **minus key** to set the current date with the day and month.
 - 4 Press the **Selector button**.
- ⇒ You now exit the menu. The date you entered is now saved.
- ▶ Press CANCEL on the display screen if you do not wish to set the date.
- ⇒ You now exit the menu. The date you entered will not be saved.

6.5.15.8 Setting units

The displayed units can be shown using the metric or imperial system. The unit can be selected from the following variables:

Variable	Metric	Imperial
Distance	km	Mi
Speed	km/h	mph
Energy consumption	Wh/km	Wh/Mi
Temperature	°C	°F
Altitude above sea level	MSL M.	ASL

Table 52: Units

- 1 Open the SETTINGS MENU.
- 2 Open <Localization><Units>.
- 3 Follow the instructions on the display.

All values are displayed in the selected unit.

6.5.15.9 Setting the time format

The clock can be displayed in 12-hour or 24-hour format.

- 1 Open the SETTINGS MENU.
 - 2 Open <Localization><Time Format>.
 - 3 Follow the instructions on the display.
- ⇒ The clock is displayed in the selected time format.

6.5.15.10 Connecting the Komoot app

The Komoot app can be connected to the FIT system. More information at: www.komoot.com/

- 1 Open the SETTINGS MENU.
 - 2 Open <Connectivity><Connect Komoot>.
 - 3 Follow the instructions on the display.
- ⇒ Komoot is now connected to the system.

6.5.15.11 Connecting the heart rate sensor

Different heart rate sensors can be connected using the Bluetooth® function.

- 1 Open the SETTINGS MENU.
 - 2 Open <Connectivity><Heart rate sensor>.
 - 3 Follow the instructions on the display.
- ⇒ The heart rate sensor is now connected to the system.

6.5.15.12 Adjusting the assistance system

The assistance system be adjusted to individual requirements. The selected assistance setting has an impact on the three levels ECO, STD and AUTO in equal measure. The motor always delivers full assistance when set at HIGH.

- 1 Open the SETTINGS MENU.
 - 2 Open <My Bike><Assistance>.
 - 3 Use the **Selector button** to make the required assistance setting:
 - If all bars are black in the indicator, assistance has been changed to the maximum setting. This setting means a shorter range.
 - If one black bar appears on the far left-hand side of the indicator, assistance has been changed to the minimum setting. This setting allows the maximum possible range at the ECO level of assistance.
 - 4 Press the **Selector button**.
- ⇒ The selected assistance setting is saved.

6.5.15.13 Calibrating the altimeter

The altimeter can be calibrated.

- 1 Open the SETTINGS MENU.
 - 2 Open <My Bike><Calibration Altitude>.
 - 3 Follow the instructions on the display.
- ⇒ The altimeter is now calibrated. Altitude measurement depends on the air pressure and deviations may arise if the air pressure fluctuates.

6.5.15.14 Adjusting the backlight

The backlight brightness can be adjusted.

- 1 Open the SETTINGS MENU.
 - 2 Open <My Bike><Auto Backlight>.
 - 3 – Select ON to use the backlight automatically adjusted to the ambient light.
– Select OFF to set the backlight brightness between 10% and 100% manually.
 - 4 Press the **Selector button**.
- ⇒ The selected backlight brightness will be used.

6.5.15.15 Adjusting the auto switch-off

It is possible to adjust the time interval after which the electric drive system will switch off automatically when it is not being used.

- 1 Open the SETTINGS MENU.
 - 2 Open <My Bike><Auto Power Off>.
 - 3 Follow the instructions on the display.
- ⇒ The electric drive system switches off automatically after the set time interval when it is not being used.

6.5.15.16 Adjusting the vibration feedback

The vibration feedback can be adjusted.

- 1 Open the SETTINGS MENU.
- 2 Open <My Bike><Vibration feedback>.
- 3 – Select **ON** if you wish every press of a button and every active message to produce vibration feedback.
– Select **OFF** if you do not wish vibration feedback to be produced.
– Select **ONLY WITH MESSAGES** if you wish vibration feedback to be produced for messages only.

⇒ The selected vibration feedback is produced.

6.5.15.17 Adjusting the charge mode

Charge mode and long-life mode can be adjusted. The faster the battery is charged, the shorter its life cycle will be. It can shorten the battery's service life by up to 50%.

- 1 Open the SETTINGS MENU.
- 2 Open <Charge>.
- 3 – Select <Normal> if you wish the battery to be charged at a normal rate.
– Select <Fast> if you wish the battery to be charged at a fast rate.
– Select <Charge to Storage> if you wish to store the battery for an extended period of time.
– Select <LONG LIFE> if you wish to extend the battery's life cycle considerably. The battery capacity is reduced as a result.

⇒ The selected charge mode is implemented.

6.5.15.18 Resetting all tour data

All values in the TOUR MAIN MENU and SUB-MENU can be reset.

- Trip
- Time
- Trip Height
- Cons.
- MAX
- AVG.

- 1 Open the SETTINGS MENU.
- 2 Open <Reset values><Trip Reset>
- 3 Follow the instructions on the display.

⇒ All tour data are reset.

6.5.15.19 Resetting to factory settings

The system settings can be reset to their factory settings.

- 1 Open the SETTINGS MENU.
 - 2 Open <Reset values>< Factory Reset>.
 - 3 Follow the instructions on the display.
- ⇒ All settings are reset to the factory settings.

6.5.15.20 Displaying error messages

- 1 Open the SETTINGS MENU.
 - 2 Open <Messages>.
- ⇒ The list of current error messages is shown.

6.5.15.21 Displaying the software version

- 1 Open the SETTINGS MENU.
 - 2 Open <About>.
- ⇒ The software versions for the individual components will be shown.

6.6 Accessories

Not included in price

We recommend a parking stand into which either the front wheel or rear wheel can be inserted securely for pedelecs which do not have a kickstand. The following accessories are recommended:

Description	Article number
Protective cover for electrical components	080-41000 ff
Panniers, system component	080-40946
Rear wheel basket, system component	051-20603
Bicycle box, system component*	080-40947

Table 53: Accessories

6.6.1 Child seat

WARNING

Crash caused by incorrect child seat

Pannier racks with a maximum load capacity under 27 kg and the down tube are unsuitable for mounting child seats and may break. Such an incorrect position may cause a crash with serious injuries for the pedelec rider or child.

- ▶ Never attach a child seat to the saddle, handlebars or down tube.

CAUTION

Crash caused by improper handling

When using child seats, the pedelec's handling characteristics and stability change considerably. This can cause a loss of control, a crash and injuries.

- ▶ You should practice how to use the child seat safely before using the pedelec in public spaces.

CAUTION

Risk of crushing due to exposed springs

The child may crush his/her fingers on exposed springs or open mechanical parts of the saddle or the seat post.

- ▶ Never install saddles with exposed springs if a child seat is being used.
- ▶ Never install suspension seat post with open mechanical parts or exposed springs if a child seat is being used.

Notice

- ▶ Observe the legal regulations on the use of child seats.
- ▶ Observe the operating and safety instructions for the child seat system.
- ▶ Never exceed the maximum permitted total weight.

The specialist dealer will advise you on which child seat system is suitable for the child and the pedelec.

The specialist dealer must install the child seat the first time to ensure that it is safely fitted.

When fitting a child seat is fitted, the dealer will ensure that the seat and seat fastening mechanism are suitable.

- all components are installed and securely fastened,
- shift cables, brake cables, hydraulic and electrical cables are adjusted as necessary,
- the pedelec rider has optimum freedom of movement
- the maximum permitted total weight of the pedelec is observed.

The specialist dealer will provide instruction on how to handle the pedelec and the child seat.

6.6.2 Trailer



Crash caused by brake failure

The braking distance may be longer if the trailer is carrying excessive load. The long braking distance can cause a crash or an accident and injuries.

- ▶ Never exceed the specified trailer load.

Notice

- ▶ The *operating* and safety instructions for the trailer system must be observed.
- ▶ Observe the statutory regulations on the use of bicycle trailers.
- ▶ Only use type-approved coupling systems.

A pedelec which is approved for towing a trailer will bear an appropriate adhesive label. You may only use trailers with a tongue load and weight which do not exceed the permitted values.

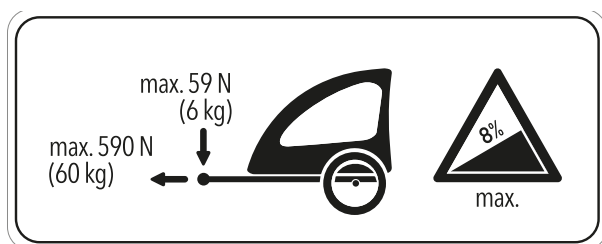

Figure 134: Trailer sign

The specialist dealer will advise you on which trailer system is suitable for the pedelec. The specialist dealer must install the trailer the first time to ensure that it is fitted safely.

6.6.2.1 Approval for trailer with Enviolo hub

Only applies to pedelecs with this equipment

Only compatible bicycle trailers are approved for ENVIOLLO hub gears.

KETTLER

KETTLER QUADRIGA child trailer

BURLY

Trailer	Adapter
Minnow Bee	Item no. 960038
Honey Bee	
Encore	
solo	
Cub	
D'Lite	
Normad	
Flatbed	
Tail Wagon	

CROOZER

Trailer	Adapter
Croozor Kid	Item no. 122003516, XL: +10 mm Item no. 122003716 Item no. 12200715 Croozor axle nut adapter with Thule coupling
Croozor Kid Plus	
Croozor Cargo	
Croozor Dog	

THULE

Trailer	Adapter
Thule Chariot Lite	Item no. 20100798
Thule Chariot Cab	
Thule Chariot Cross	
Thule Chariot Sport	
Thule Coaster XT	

6.6.2.2 Approval for trailer with ROHLOFF hub

Only applies to pedelecs with this equipment

ROHLOFF Speedhub 500/14

As a basic rule, it is permitted to use a trailer in combination with the ROHLOFF SPEEDHUB 500/14.

There must be **no component contact** with the cover of the ROHLOFF E-14 gear shift unit caused by pressure or tension at any time during assembly or when riding with the trailer **under any circumstances**.

Collision causing possible damage to the ROHLOFF E-14 gear shift unit can be avoided with suitable washers or special axle adapters (spacers or polygon) from the coupling manufacturer concerned.

Speedhub with A-12



Risk of an accident

The A-12 attachment screw has a very low screw-in depth. The screw or the thread in the axle plate can be damaged or ripped out if a trailer hitch is fitted directly onto the axle or the A-12 attachment screw. This may cause an accident with injuries.

- ▶ Never fit a trailer hitch directly on the axle and the A-12 attachment screw to a ROHLOFF Speedhub with an A-12 axle system in a 12 mm quick release axle frame.

6.6.3 Mobile holder

Only applies to pedelecs with this equipment

A holder for SP Connect mobile case is fitted to the stem.

- ✓ Observe the operating instructions for the mobile and the SP Connect mobile case.
- ✓ Use on tarmacked roads only.
- ✓ Protect mobile from theft.
- ▶ To attach: insert the SP Connect mobile case in the holder and turn 90° to the right.
- ▶ To release: turn the SP Connect mobile case 90° to the left and remove.

6.6.4 Tubeless and airless tyres

Riding a pedelec without tubes reduces the risk of tyre punctures or even avoids them completely.

The specialist dealer will advise you on which tyre system is suitable for the pedelec.

A specialist dealer must carry out conversion to tubeless or airless tyres for safety reasons.

6.6.5 Suspension fork coil spring

If the desired suspension fork sag cannot be achieved after adjustment, the coil spring assembly must be replaced with a softer or harder spring.

- ▶ Fit a softer coil spring assembly group to increase the sag.

Fit a harder coil spring assembly group to decrease the sag.

6.6.6 Pannier rack

The specialist dealer will advise on choosing a suitable pannier rack.

The specialist dealer must install the pannier rack the first time to ensure that it is safely fitted.

When installing a pannier rack, the specialist dealer makes sure that the fastening mechanism is suitable for the pedelec and that all components are installed and firmly fastened. They will also ensure that shift cables, brake cables, hydraulic lines and electrical cables are adjusted as necessary, the person riding has optimum freedom of movement and the pedelec's maximum permitted total weight is not exceeded.

The specialist dealer will provide instruction on how to handle the pedelec and the pannier rack.

6.6.7 Panniers and cargo boxes

- ▶ Use a paint protection film when attaching panniers. This will reduce abrasion on paint and wear on components.

6.7 Personal protective equipment and accessories for road safety

Seeing and being seen is crucial in road traffic. The following requirements must be met for riding a pedelec safely on public roads.

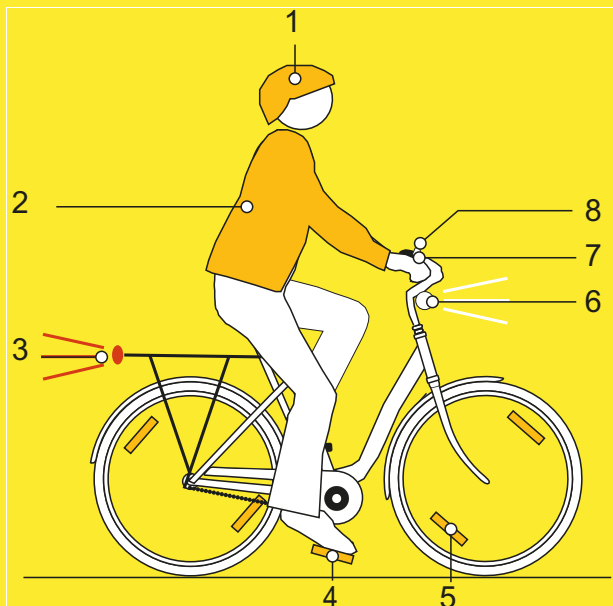

Figure 135: Road safety

- 1 The helmet must have a reflective strip or a light in a clearly visible colour.
- 2 **Cycle clothing** is essential at all times of year. Clothing should be retroreflective or as light as possible. Fluorescent materials are also suitable. High-visibility jackets and straps on your upper body ensure even greater safety. Never wear a skirt. Always wear trousers which reach down to your ankles instead.
- 3 The **large red reflector** with a “Z” registration mark and the **red rear light** must be clean. The rear light is attached high enough so that cars can see it (minimum height 25 cm). The rear light must work.
- 4 The two **reflectors on the two non-slip pedals** must be clean.
- 5 The **yellow spoke reflectors** on both wheel or the **white, fluorescent surface** on both wheels must be clean.
- 6 The **white front light** must work and must be positioned so that it does not dazzle other road users. The white front light and the **white reflector** must be clean at all times.

- 7 The **two separate brakes** on the pedelec must work at all times.
- 8 The **clear sounding bell** must be fitted and must work.

6.8 Before each ride

- ▶ Check pedelec before each ride; see Section [7.1](#).

Check list before each ride		
<input type="checkbox"/>	Check everything is sufficiently clean.	See Section 7.2 .
<input type="checkbox"/>	Check guards.	See Section 7.1.1 .
<input type="checkbox"/>	Check battery to ensure it is firmly in place.	See Section 6.16.2 .
<input type="checkbox"/>	Check lights.	See Section 7.1.13 .
<input type="checkbox"/>	Check brake.	See Section 7.1.14 .
<input type="checkbox"/>	Check suspension seat post.	See Section 7.1.9 .
<input type="checkbox"/>	Check pannier rack.	See Section 7.1.5 .
<input type="checkbox"/>	Check bell.	See Section 7.1.10 .
<input type="checkbox"/>	Check handles.	See Section 7.1.11 .
<input type="checkbox"/>	Check rear frame damper.	See Section 7.1.4 .
<input type="checkbox"/>	Check frame.	See Section 7.1.2 .
<input type="checkbox"/>	Check wheel concentricity.	See Section 7.1.7 .
<input type="checkbox"/>	Check quick releases.	See Section 7.1.8 .
<input type="checkbox"/>	Check mudguards.	See Section 7.1.6 .
<input type="checkbox"/>	Check USB cover.	See Section 7.1.12 .

- ▶ Be alert to any unusual noises, vibrations or odours while riding. Be alert to any unusual operating sensations when braking, pedalling or steering. This indicates material fatigue.
- ⇒ Take pedelec out of service if there are any deviations from the “Before each ride” checklist or any unusual behaviour. Contact specialist dealer.

6.9 Straightening the quickly adjustable stem

Only applies to pedelecs with this equipment

- 1 Open stem clamping lever.

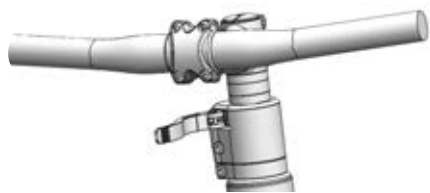

Figure 136: Example of All Up with open stem clamping lever

- 2 Pull handlebars into the highest possible position.

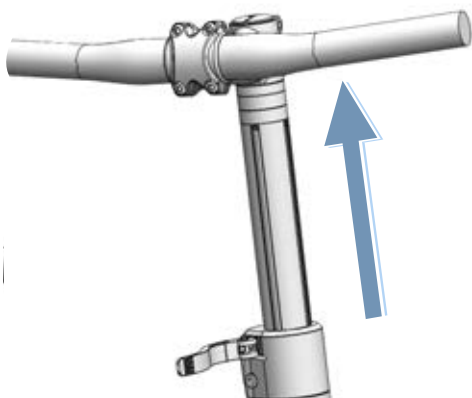

Figure 137: Example of All Up pulled into highest possible position

- 3 Turn handlebars 90° anti-clockwise so that they are straight.

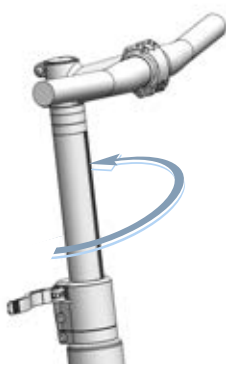

Figure 138: Example of All Up in straight position

- 4 Place handlebars at required height.
- 5 Close stem clamping lever.

6.10 Using the pannier rack



Crash caused by loaded pannier rack

The pedelec is handled differently with a loaded *pannier rack*, in particular when the rider needs to steer and brake. This can lead to a loss of control. This may cause a crash with injuries.

- ▶ You should practice how to use a loaded *pannier rack* safely before using the pedelec in public spaces.

Crushing the fingers in the spring flap

The spring flap on the *pannier rack* operates with a high clamping force. There is a risk of crushing the fingers.

- ▶ Never allow the spring flap to snap shut in an uncontrolled manner.
- ▶ Be careful where you position your fingers when closing the spring flap.

Crash caused by unsecured baggage

Loose or unsecured objects on the *pannier rack*, e.g. belts, may become caught in the rear wheel. This may cause a crash with injuries.

Objects which are fastened to the *pannier rack* may cover the *reflectors* and the *riding light*. Other users may not see the pedelec on public roads as a result. This may cause a crash with injuries.

- ▶ Secure any objects which are attached to the *pannier rack* sufficiently.
- ▶ Objects fastened to the *pannier rack* must never cover the *reflectors*, the *headlight* or the *rear light*.

- ▶ Distribute the baggage as evenly as possible between the left- and right-hand side.
- ▶ We recommend the use of panniers and baggage baskets.



Figure 139: The maximum load bearing (1) capacity is indicated on the pannier rack

- ▶ Pack the pedelec to its *maximum permitted total weight* (PTW) only.
- ▶ Pack the pedelec to the pannier rack's (1) maximum load capacity only.
- ▶ Use the original pannier rack only.

6.11 Raising the kickstand

- ▶ Use your foot to raise kickstand completely before setting off.

6.12 Using the saddle

- ▶ Do not wear studded jeans as these can damage the saddle covering.
- ▶ Wear dark clothes for your first few rides as new leather saddles can stain clothing.

Riders often experience pain in the sitting bones, especially beginners or at the start of the season, after a longer break. The periosteum around the sitting bones is irritated as it is unaccustomed to the chafing. To reduce chafing:

- ▶ wear cycling shorts with shock-absorbing seat padding
 - ▶ use a chamois cream or ointment.
- ⇒ The sensation of pain is reduced after five to six rides, although it may increase again after two to three weeks of riding.

6.12.1 Using the leather saddle

Sunlight and UV light tarnish the colour and cause the leather to dry out and fade.

- ▶ Park pedelec in the shade.
- ▶ Always use a saddle cover.

Moisture may cause the leather to detach from material beneath and mould may form.

- ▶ If the leather saddle gets wet, dry saddle completely.
- ▶ Always use a saddle cover.

6.13 Using the pedals

- ▶ The ball of the foot is placed on the pedal when riding and pedalling.

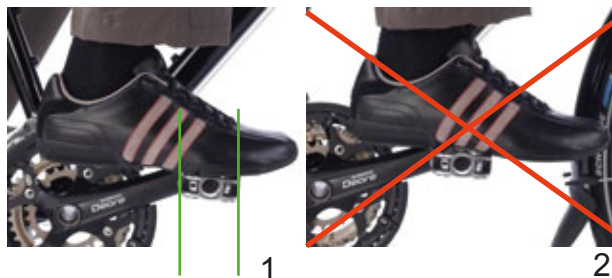

Figure 140: Correct (1) and incorrect (2) foot position on the pedal

6.14 Using the bell

- 1 Press the bell button downwards.
- 2 Let button spring back.

6.15 Using the handlebars

- ▶ Wear heavily padded cycling gloves.
- ⇒ This supports sensitive areas of your palms.
- ▶ Vary your grip position continuously while riding.
- ⇒ This prevents overstraining and fatigue in your hands.

6.15.1 Using multi-position handlebars

Only applies to pedelecs with this equipment

Multi-position handlebars are ideal for dynamic riding. The contoured ends of the handlebars, also known as horn handlebars, provide a variety of grip options. Changing muscle groups reduces strain on the hands, arms and back during longer rides.

- ▶ Vary your grip position continuously while riding.
- ⇒ This prevents overstraining and fatigue in your hands.

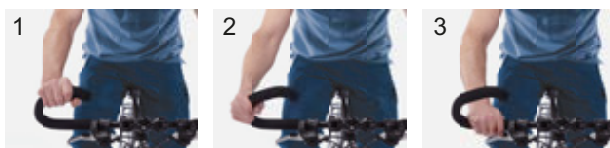

Figure 141: Grip positions on the multi-position handlebars

Grip position 1

The top grip position is suitable for riding slowly.

- ▶ Straighten your upper body without tensioning in this position.

Grip position 2 and 3

The middle and bottom grip position is suitable for fast rides and riding on inclines.

- ▶ In the middle position, hold the arm and wrist upright and relax tension.
- ▶ In the bottom position, place your upper body slightly lower. Keep your fingers close to the brake handle ready for use.

6.15.2 Using bar ends

Only applies to pedelecs with this equipment

Bar ends can be added to normal handlebars.

Adjustable bar ends feature a ball joint which you can use to choose the optimum position as required.

- ▶ Adjust bar ends correctly. To do so, your hand, elbow and shoulder must be in line with one another when the hand takes hold of the bar ends
- ▶ During the ride, keep varying your grip position between a flat (1) and upright (2) hand position.
- ⇒ This prevents overstraining, fatigue and numbness in your hands and fingers.



Figure 142: Grip positions on a bar end

6.15.3 Using leather handles

Only applies to pedelecs with this equipment

Sweat and grease from the skin are two of the greatest enemies of leather. They penetrate the surface of leather and cause it to disintegrate more quickly, meaning the leather can soften and abrade.

- ▶ Wear gloves.

Sunlight and UV light damage the colour and can cause the leather to dry out and fade.

- ▶ Park pedelec in the shade.

Moisture may cause the leather to detach from material beneath and mould may form.

- ▶ If the leather handles get wet, dry handles completely.

6.16 Using the battery

- ✓ Switch off the battery and the electric drive system before removing or inserting the battery.

6.16.1 Removing the battery

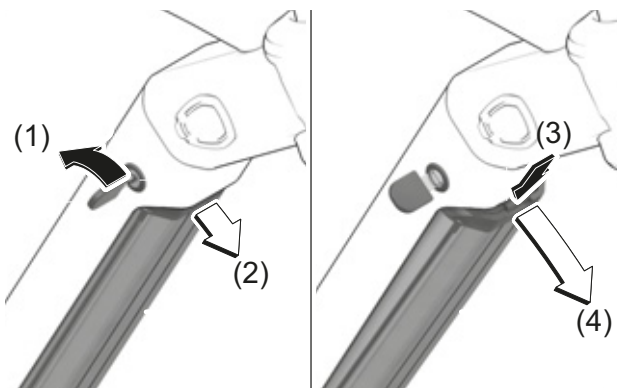

Figure 143: Removing the battery

- 1 Open battery lock with battery key (1).
 - ⇒ The battery is released and falls into the retainer guard (2).
- 2 Hold the battery in your hand from below. Use the other hand to push on the retainer guard from above (3).
 - ⇒ The battery is released and falls into the hand (4).
- 3 Remove the battery from the frame.
- 4 Remove the battery key from the battery lock.

6.16.2 Inserting the battery

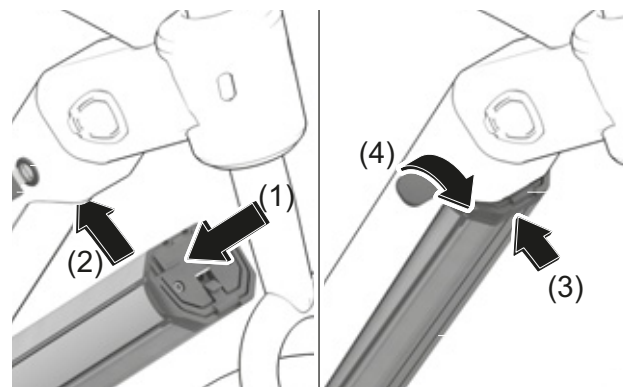

Figure 144: Inserting the battery

- 1 Place the battery into the battery lower mount with the contacts facing the front (1).
- 2 Flip the battery upwards so that the battery is held by the retainer guard (2).
 - ⇒ There is an audible clicking noise.
- 3 Push the battery upwards (3).
- 4 Check battery to ensure it is firmly in place.
- 5 Lock the battery with the battery key; otherwise, the battery may fall out of the mount when you open the see (4).
- 6 Remove the battery key from the battery lock.
- 7 Check the battery to ensure it is firmly in place before each ride.

6.16.3 Charging the battery

- ✓ The ambient temperature during the charging process must be within the range from 0 °C to 40 °C.
 - ✓ The battery can remain on the pedelec or can be removed for charging.
 - ✓ Interrupting the charging process does not damage the battery.
- 1 Remove the cable connection cover if necessary.
 - 2 Connect the mains plug of the charger to a normal domestic, grounded socket.

Connection data	230 V, 50 Hz
-----------------	--------------

Notice

- ▶ Check that mains voltage! The power source voltage must match the voltage indicated on the charger nameplate. Chargers labelled 230 V may be operated at 220 V.
- 3 Connect the charging cable to the battery's charging port.
- ⇒ The charging process starts automatically.
 - ⇒ The battery level indicator shows the battery level during charging.

Selection	Description
At rest	Green, flashing rapidly (2× a second)
Charging	Red I
Charging complete	Green
Fault	Red, flashing (1× a second)

- ⇒ When the electric drive system is switched on, the *display screen* shows the charging process.
- 4 The charging process is complete when the LEDs on the **battery level indicator** turn green.
 - 5 Disconnect the battery from the charger.
 - 6 Disconnect the charger from the mains.

6.17 Using the electric drive system

6.17.1 Switching on the electric drive system



Crash caused by lack of readiness for braking

When it is switched on, you can activate the electric drive system by applying force on the pedals. There is a risk of a crash if the electric drive system is activated unintentionally and the brake is not applied.

- ▶ Never start the electric drive system, or switch it off immediately, if the brake cannot be reached safely and reliably.

- ✓ A sufficiently charged battery has been inserted into the pedelec.
- ✓ The battery is firmly in place. The key has been removed.



Figure 145: On-Off button (1)

- ▶ Press **On-Off button (on-board computer)** at least one second.
- ⇒ The electric drive system is switched on. The Drive main menu is displayed.
- ⇒ If the electric drive system is switched on, the motor is activated as soon as the pedals are moved with sufficient force.

6.17.2 Switching off the electric drive system

The system switches off automatically a few minutes after the last command.

The following options are available to switch off the electric drive system manually:

- ▶ Press the **On-Off button (on-board computer)**.
- or**

- ▶ Press the **On-Off button (battery)** for a long time.

- ▶ The display and LEDs on the **battery level indicator** will disappear.

⇒ The electric drive system is switched off.

6.18 Using the on-board computer

6.18.1 Using the push assist system



Injury from pedals or wheels

The pedals and the drive wheel turn when the push assist system is used. There is a risk of injury if the pedelec wheels are not in contact with the ground when the push assist system is used (e.g. when carrying the pedelec up stairs or when placing it on a bicycle rack).

- ▶ Only use the push assist mode when pushing the pedelec.
- ▶ You must steer the pedelec firmly with both hands when using push assist.
- ▶ Allow for enough freedom of movement for the pedals.

The push assist system helps move the pedelec. The speed is a maximum of 6 km/h.

- ✓ The electric drive system is switched on.



Figure 146: Position of push assist button

- 1 Press the **push assist button** briefly.
⇒ The push assist mode is switched on.
- 2 Press and hold the **push assist button** again within 3 seconds.
⇒ Push assist is switched on.

- 3 Release the **push assist button** to switch off the push assist system.
- 4 Push assist mode switches off if the **push assist button is released for ten seconds**. Push assist mode will also switch off automatically if the speed exceeds 6 km/h.

6.18.2 Using the riding light



Figure 147: Position of riding light button

- ✓ The electric drive system needs to be switched on already to turn on the *riding light*.

- ▶ Press the **riding light button**.

The lighting modes change in the following order:

	1 dimmed headlight (only applies to pedelecs with this equipment)
	2. Main beam (only applies to pedelecs with this equipment)
	3. Light off

Table 54: Overview of riding light symbols

6.18.3 Selecting the level of assistance

The maximum motor power depends on the selected level of assistance. On-board computer is used to configure to what extent the electric drive should assist the rider when pedalling. You can change the level of assistance at any time.



Figure 148: Position of plus (1), minus (2), and push assist (3) buttons

► Press the **plus button**.

⇒ The level of assistance is increased.

► Press **minus button**.

⇒ The level of assistance is reduced.

6.18.4 Using the boost function

In the [BOOST] level of assistance, the motor power can be increased to [HIGH] irrespective of the selected level of assistance.

1 Press the push assist button to switch on the [BOOST] function.

2 Release the push assist button to switch off the [BOOST] function.

6.19 Using the brake



Crash caused by brake failure

Oil or lubricant on the brake disc in a disc brake or on the rim of a rim brake can cause the brake to fail completely. This may cause a crash with serious injuries.

- ▶ Never allow oil or lubricant to come into contact with the brake disc or brake linings or on the rim of a rim brake.
- ▶ If the brake linings have come into contact with oil or lubricant, contact specialist dealer to have the components cleaned or replaced.

If the brakes are applied continuously for a long time (e.g. while riding downhill for a long time), the fluid in the brake system may heat up. This may create a vapour bubble. This will cause air bubbles or water contained in the brake system to expand. This may suddenly make the lever travel wider. This may cause a crash with serious injuries.

- ▶ Release the brake regularly when riding downhill for a longer period of time.
- ▶ Use the front and rear wheel brakes alternately.

The motor's drive force is switched off during the ride as soon as the pedelec rider is no longer pedalling. The electric drive system does not switch off when braking.

- ▶ Do not pedal while braking to ensure optimum braking.

6.19.1 Use handbrake

Only applies to pedelecs with this equipment

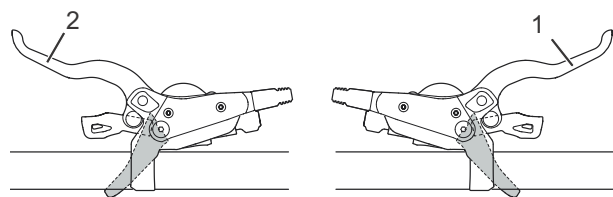

Figure 149: Handbrake, front (2) and rear (1) – Shimano brake used as an example

- ▶ Pull the left *handbrake* to apply the front wheel brake.
- ▶ Pull the right handbrake to apply the rear wheel brake.

6.19.2 Using the back-pedal brake

Only applies to pedelecs with this equipment

- 1 Move pedals a little beyond the 3 o'clock and 9 o'clock position.
- 2 Pedal in the opposite direction to the *direction of travel* until the desired speed has been reached.

6.20 Use suspension and damping

Compression adjuster set to hard

- Causes the suspension fork to move higher within the deflection range. This improves efficiency, maintains momentum and makes it easier to ride over uniformly hilly terrain and around bends.
- Deflection may feel somewhat harder on rugged terrain.

Compression adjuster set to soft

- Causes the fork to deflect quickly and easily. This makes it easier to maintain speed and momentum when riding over uneven rugged terrain.
- Deflection feels somewhat less hard on rugged terrain.



Figure 150: Optimum ride performance over bumps

When optimally adjusted, the fork deflects quickly and unhindered when the bike hits bumps and absorbs a bump. Traction is retained (blue line).

The fork responds quickly to the bump. The headset and handlebars rise slightly when absorbing a bump (green line).

Threshold

The damping threshold prevents deflection until a medium impact or downward force occurs. Threshold mode increases drive efficiency over level terrain.

The threshold setting can be used to improve pedalling efficiency over flat or hilly terrain. In threshold mode, higher pedelec speeds lead to greater impact force when a pedelec hits a bump, causing the fork to deflect, and the bump is absorbed.

- When the compression adjuster is in the open position (against the stop in an anti-clockwise direction), the suspension fork deflects quickly and unhindered through its entire deflection range when an impact or downward force occurs.
- When the compression adjuster is in the threshold position, the suspension fork counteracts deflection until a medium impact or downward force occurs.
- When the compression adjuster is in the blocked position (against the stop in a clockwise direction), the suspension fork counteracts deflection throughout its deflection range until a strong impact or downward force occurs.

6.20.1 Adjusting the SR SUNTOUR compression adjuster

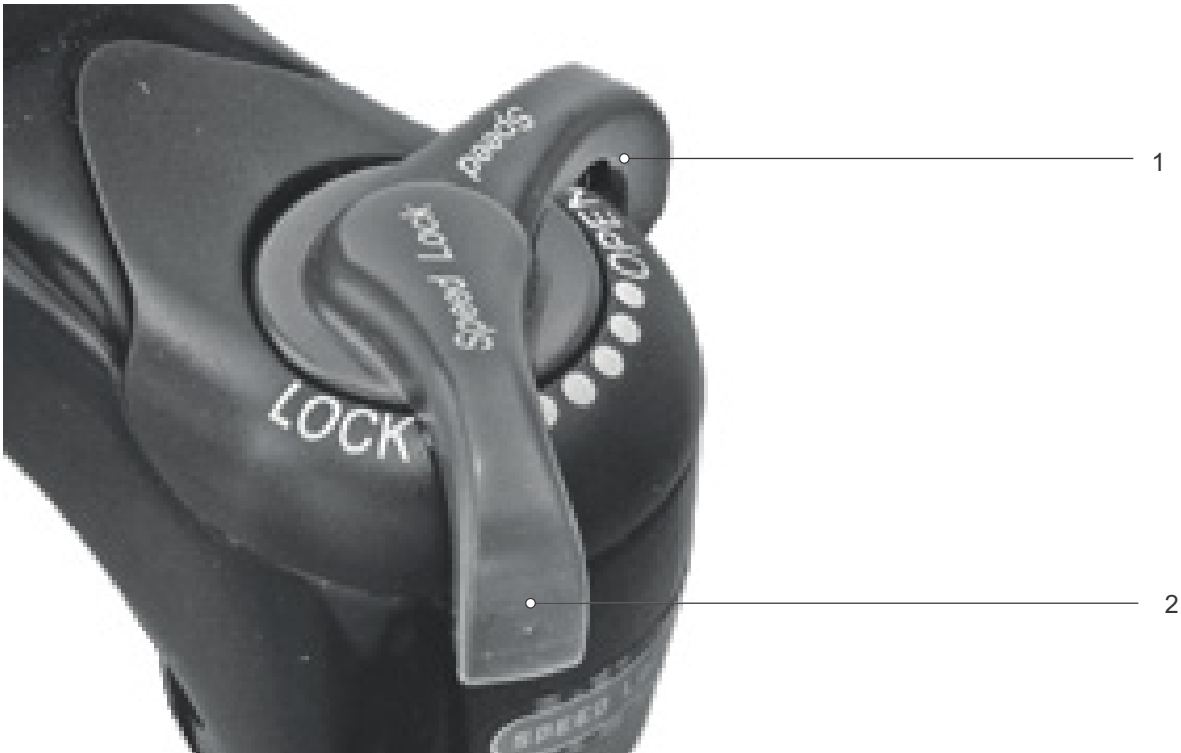

Figure 151: SR SUNTOUR compression adjuster in open (1) and closed (2) position

► Place **compression adjuster** in the OPEN position.

⇒ The compression adjuster is open.

► Place **compression adjuster** in the LOCK position.

⇒ The compression adjuster is locked.

► Position **compression adjuster** between OPEN and LOCK.

⇒ This position allows you to fine-tune the compression adjuster.

We recommend setting the **compression adjuster** to the OPEN position first.

6.21 Gear shift

The selection of the appropriate gear is a prerequisite for a physically comfortable ride and making sure that the electric drive system functions properly. The ideal pedalling frequency is between 70 and 80 revolutions per minute.

- ▶ Stop pedalling briefly when changing gears. This makes it easier to switch gears and reduces *Wear* on the drive train.

6.21.1 Using the derailleur gears

The speed and range can be increased while applying the same force if you select the right gear.

- ✓ Stop pedalling briefly when changing gears. This makes it easier to switch gears and reduces *Wear* on the drive train. However, keep the crank moving while switching gears.

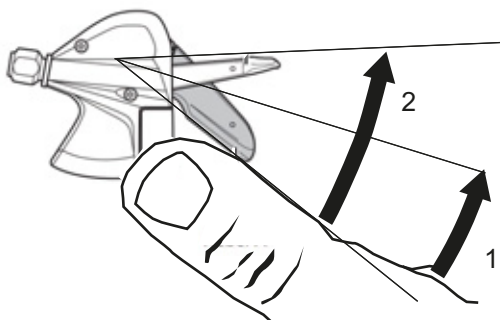

Figure 152: Switching gears with lever A, using gear shift SL-M315 as an example

Lever A switches from a smaller pinion to a larger one. The number of pinions switched depends on the selected position of lever A.

- ▶ Place shifter A in position 1.
- ⇒ System shifts one pinion higher.
- ▶ Place shifter A in position 2.
- ⇒ System shifts two pinions higher.

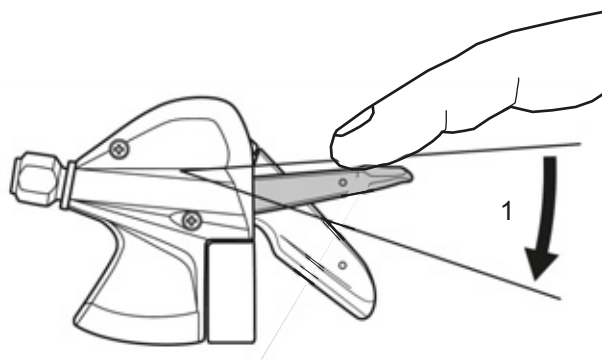

Figure 153: Switching gears with lever B, using gear shift SL-M315 as an example

Lever B switches from a larger pinion to a smaller one.

- ▶ Place shifter B in position 1.
- ⇒ System shifts one pinion lower.

Switching gears

- ▶ Select the appropriate gear with the gear shift unit.
- ⇒ The gear shift switches gear.
- ⇒ The shifter returns to its original position.
- ▶ Clean and lubricate the rear derailleur if gear changes block.

6.21.2 Use SHIMANO hub gear

Only applies to pedelecs with this equipment

CAUTION

Crash caused by incorrect use

If the rider applies too much pressure on the pedals during a gear change and activates the shifter or changes several gears at a time, their feet may slip from the pedals. This may cause a crash or flip-over with injuries.

Switching down several gears to a low gear may cause the twist grip outer sleeve to suddenly come off. This will not have an adverse effect on the twist grip's correct functioning since the outer guide returns to its original position after the gear change is complete.

- ▶ Apply little pressure on the pedals while changing gears.
- ▶ Never change more than one gear at a time.

Notice

The interior hub is not completely waterproof. If water gets into the hub, it may rust and the gear switch function may no longer function as a result.

- ▶ Never use the pedelec in places where water may get into the hub.

In rare cases, noises may be heard from the rear derailleur in the hub interior after a gear change. This is normal when gears are changed.

- ▶ Never detach the hub yourself. Contact specialist dealer.

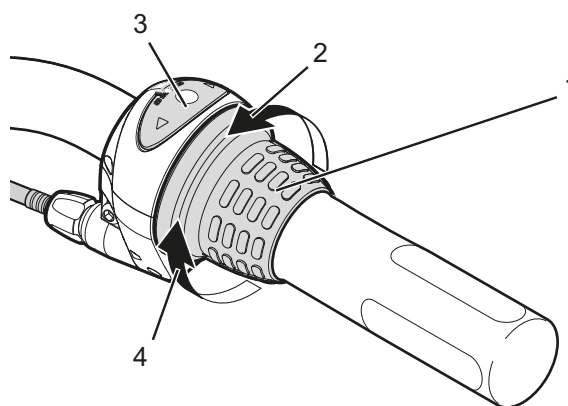

Figure 154: Example: use of SHIMANO Nexus gear shift

- ▶ Turn the twist grip (1) backwards to switch up a gear (4).
 - ▶ Turn the twist grip (1) forwards to switch down a gear (2).
- ⇒ The gear shift switches gear.
- ⇒ The screen display (3) shows the changed gear.

6.21.3 Using eShift

eShift refers to the integration of electronic gear shift systems into the electric drive system.

6.21.3.1 Using eShift with SHIMANO DI2 automatic hub gears

Only applies to pedelecs with this equipment

The automatic SHIMANO DI2 hub gear can be used in manual or automatic mode. Use the shifter to change gears in manual mode. In automatic mode, the shift system changes gear automatically depending on the speed, pedalling power and pedalling frequency. You will find how to switch from automatic to manual mode, depending on the shifter used, described in your operating instructions on the on-board computer. If you use the shifter when in automatic mode, the gear system will change to the next gear and it will remain in automatic mode. Manual gear changes in automatic mode influence shift behaviour in the gear system and adjust gear changes to ride performance. If the system is switched on for the first time when a new, unused wheel is used, the system will learn the gears first. To do so, the automatic system changes to the highest/most difficult gear and then switches through all gears during the first ride. The new gear is shown briefly on the on-board computer each time it is changed.

Since the motor detects the gear shift and consequently reduces motor assistance briefly, it is possible to switch gears under load or on hills. If the pedelec is brought to a halt from a speed greater than 10 km/h, the system can automatically switch back to a pre-set START GEAR.

- ▶ Adjust the START GEAR in the system settings if necessary.

6.21.3.2 Using eShift with manual SHIMANO DI2 hub gears

Only applies to pedelecs with this equipment

The new gear is shown briefly on the on-board computer each time it is changed.

Since the motor detects the gear shift and consequently reduces motor assistance briefly, it is possible to switch gears under load or on hills.

If the pedelec is brought to a halt from a speed greater than 10 km/h, the system can automatically switch back to a pre-set START GEAR.

- ▶ Adjust the START GEAR in the system settings if necessary.

6.21.3.3 Using eShift with SHIMANO DI2 automatic hub gears

Only applies to pedelecs with this equipment

Since the motor detects the gear shift and consequently reduces motor assistance briefly, it is possible to switch gears under load or on hills.

- ⇒ The new gear is shown briefly on the on-board computer each time it is changed.

6.22 Parking

Notice

Heat or direct sunlight can cause the *tyre pressure* to increase above the permitted maximum pressure. This can destroy the *tyres*.

- ▶ Park pedelec in the shade.
- ▶ On hot days, regularly check the *tyre pressure* and adjust it as necessary.

Moisture penetrating at low temperatures may impair individual functions due to the open structural design.

- ▶ Always keep the pedelec dry and free from frost.
- ▶ If the pedelec is used at temperatures below 3 °C, the specialist dealer must perform a major inspection beforehand and prepared it for winter use.

The pedelec's force of weight may cause the kickstand to sink into soft ground, possibly causing the pedelec to topple over as a result.

- ▶ The pedelec must be parked on firm, level ground only.

- 1 Switch off electric drive system; see Section 6.17.2.
- 2 After getting off, use your foot to lower the kickstand completely before parking. Ensure that it is stable.
- 3 Park the pedelec carefully and check that it is stable.
- 4 Protect saddle with saddle cover if you park the pedelec outside.
- 5 Lock the pedelec with the bicycle lock.
- 6 Remove battery to protect against theft; see Section 6.16.1.
- 7 Clean and service pedelec after every ride; see Section 7.2.

Check list after each ride

Cleaning		
<input type="checkbox"/>	Lights and reflectors	See Section 7.2.5.
<input type="checkbox"/>	Brake	See Section 7.2.5.
<input type="checkbox"/>	Suspension fork	See Section 7.2.1.
<input type="checkbox"/>	Suspension seat post	See Section 7.2.6.
<input type="checkbox"/>	Rear frame damper	See Section 7.2.7.
<input type="checkbox"/>	Pedal	See Section 7.2.4.
Care		
<input type="checkbox"/>	Suspension fork	See Section 3.

6.22.1 Screwing in the All Up handlebars

Only applies to pedelecs with this equipment

Screw in the All Up stem to save space when parking

- 1 Open stem clamping lever.

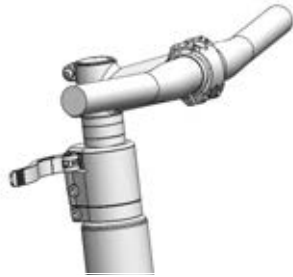

Figure 155: All Up with open stem clamping lever

- 2 Pull handlebars into highest possible position.

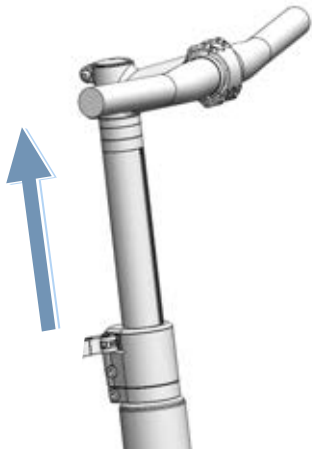

Figure 156: All Up pulled into highest possible position

- 3 Turn handlebars 90° in a clockwise direction.

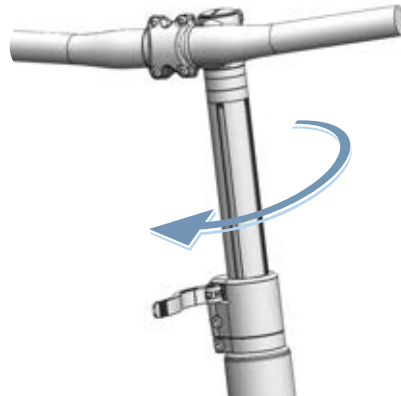

Figure 157: All Up screwed in

- 4 Place handlebars at required height.
- 5 Close stem clamping lever.

7 Cleaning, servicing and inspection

- Clean, maintain and inspect pedelec as indicated on checklists.
Complying with these cleaning instructions can increase operational reliability, reduce wear on components, extend the service life of components and ensure safety.

Checklist: Before each ride		
<input type="checkbox"/>	Check everything is sufficiently clean	See Section 7.2.
<input type="checkbox"/>	Check guards	See Section 7.1.1.
<input type="checkbox"/>	Check battery to ensure it is firmly in place	See Section 6.17.2.
<input type="checkbox"/>	Check lights	See Section 7.1.13.
<input type="checkbox"/>	Check brake	See Section 7.1.14.
<input type="checkbox"/>	Check suspension seat post	See Section 7.1.9.
<input type="checkbox"/>	Check pannier rack	See Section 7.1.5.
<input type="checkbox"/>	Check bell	See Section 7.1.10.
<input type="checkbox"/>	Check handles	See Section 7.1.11.
<input type="checkbox"/>	Check rear frame damper	See Section 7.1.4.
<input type="checkbox"/>	Check wheel concentricity	See Section 7.1.7.
<input type="checkbox"/>	Check frame	See Section 7.1.2.
<input type="checkbox"/>	Check quick releases	See Section 7.1.8.
<input type="checkbox"/>	Check guards	See Section 7.1.6.
<input type="checkbox"/>	Check USB cover	See Section 7.1.12.
Checklist: After each ride		
<input type="checkbox"/>	Clean lights	See Section 7.2.1.
<input type="checkbox"/>	Clean reflectors	See Section 7.2.1.
<input type="checkbox"/>	Clean brake	See Section 7.2.5.
<input type="checkbox"/>	Clean suspension fork	See Section 7.2.2.
<input type="checkbox"/>	Care for suspension fork	See Section 3.
<input type="checkbox"/>	Clean suspension seat post	See Section 7.2.6.
<input type="checkbox"/>	Clean rear frame damper	See Section 7.2.7.
<input type="checkbox"/>	Clean the pedals	See Section 7.2.4.

Checklist: weekly tasks		
<input type="checkbox"/>	Clean chain	See Section 7.3.18.
<input type="checkbox"/>	City, folding, cargo and children's bikes and bicycles for young adults	When dry: every 10 days In wet conditions: every 2–6 days
<input type="checkbox"/>	Trekking and racing bikes	When dry: every 140... 200 km In wet conditions: every 100 km
<input type="checkbox"/>	Mountain bikes	When dry: every 60... 100 km In wet conditions: after every ride
<input type="checkbox"/>	Belt (every 250–300 km)	See Section 7.3.17.
<input type="checkbox"/>	Care for chain.	see Section 7.4.16 and 7.4.16.1
<input type="checkbox"/>	City, folding, cargo and children's bikes and bicycles for young adults	When dry: every 10 days In wet conditions: every 2... 6 days
<input type="checkbox"/>	Trekking and racing bikes	When dry: every 140... 200 km In wet conditions: every 100 km
<input type="checkbox"/>	Mountain bikes	When dry: every 60... 100 km In wet conditions: maintain all the time
<input type="checkbox"/>	Maintain all-round chain guard.	See Section 7.4.16.1.
<input type="checkbox"/>	Check tyre pressure (at least once a week)	See Section 7.5.1.1.
<input type="checkbox"/>	Check tyres (every 10 days)	See Section 7.5.1.2.
<input type="checkbox"/>	eightpins seat post Refill oil (every 20 hours)	See Section 7.4.19.

Checklist: monthly tasks		
<input type="checkbox"/>	Cleaning the battery	See Section 7.3.2.
<input type="checkbox"/>	Clean control panel	See Section 7.3.1.
<input type="checkbox"/>	Clean on-board computer	See Section 7.3.1.
<input type="checkbox"/>	Check disc brake linings (once a month or after braking 1,000 times)	See Section 7.5.2.6.
<input type="checkbox"/>	Check rim brake brake linings (once a month or after braking 3000 times)	See Section 7.5.1.3.
<input type="checkbox"/>	Check the rim brake surface.	See Section 7.5.2.6.
<input type="checkbox"/>	Clean handbrake	See Section 7.3.15.1.
<input type="checkbox"/>	Clean brake disc	See Section 7.3.16.
<input type="checkbox"/>	Check brake disc	See Section 7.5.2.4.
<input type="checkbox"/>	Check brake Bowden cables.	See Section 7.5.2.3.
<input type="checkbox"/>	Clean pannier rack	See Section 7.3.4.
<input type="checkbox"/>	Clean handles	See Section 7.3.7.
<input type="checkbox"/>	Care for handles	See Section 7.4.8.
<input type="checkbox"/>	Check handbrake	See Section 7.5.2.1.
<input type="checkbox"/>	Check hydraulic system	See Section 7.5.2.2.
<input type="checkbox"/>	Clean cassette	See Section 7.3.14.
<input type="checkbox"/>	Clean chain and all-round chain guard	See Section 7.3.18.1.
<input type="checkbox"/>	Clean chain wheels	See Section 7.3.14.
<input type="checkbox"/>	Clean leather handles	See Section 7.3.7.1.
<input type="checkbox"/>	Care for leather handles	See Section 7.4.8.2.
<input type="checkbox"/>	Clean the leather saddle	See Section 7.3.9.1.
<input type="checkbox"/>	Care for leather saddle	See Section 7.4.11.
<input type="checkbox"/>	Clean handlebars	See Section 7.3.6.

Checklist: monthly tasks		
<input type="checkbox"/>	Cleaning the motor	See Section 7.3.3.
<input type="checkbox"/>	Clean hub	See Section 7.3.12.
<input type="checkbox"/>	Cleaning the frame	See Section 7.3.4.
<input type="checkbox"/>	Clean tyres	See Section 7.3.10.
<input type="checkbox"/>	Check back-pedal brake	See Section 7.5.2.5.
<input type="checkbox"/>	Clean saddle	See Section 7.3.9.
<input type="checkbox"/>	Clean seat post	See Section 7.3.8.
<input type="checkbox"/>	Care for seat post	See Section 7.4.9.
<input type="checkbox"/>	Clean shifter	See Section 7.3.13.1.
<input type="checkbox"/>	Cleaning gear shift	See Section 7.3.13.
<input type="checkbox"/>	Clean shift cables	See Section 7.3.13.
<input type="checkbox"/>	Check disc brake	See Section 7.5.2.4.
<input type="checkbox"/>	Clean mudguard	See Section 7.3.4.
<input type="checkbox"/>	Clean kickstand	See Section 7.3.4.
<input type="checkbox"/>	Clean spokes and spoke nipples	See Section 7.3.11.
<input type="checkbox"/>	Care for spoke nipples	See Section 7.4.13.
<input type="checkbox"/>	Clean rigid fork	See Section 7.3.4.
<input type="checkbox"/>	Clean transmission	See Section 7.3.13.
<input type="checkbox"/>	Clean front derailleur	See Section 7.3.14.
<input type="checkbox"/>	Clean stem	See Section 7.3.5.

Check list for tasks every three months		
<input type="checkbox"/>	Check brake pressure point	See Section 7.5.2.1.
<input type="checkbox"/>	Check rim brake (100 hours trip time or every 2,000 km)	See Section 7.5.2.6.
<input type="checkbox"/>	Checking the spokes	See Section 7.5.1.3.

Checklist: at least every six months (or every 1,000 km)	
<input type="checkbox"/>	Check Bowden cables gear shift See Section 7.5.15.2 .
<input type="checkbox"/>	Maintain handbrake See Section 7.4.18.1 .
<input type="checkbox"/>	Care for carbon seat post See Section 7.4.9.2 .
<input type="checkbox"/>	Check gear shift electric cables See Section 7.5.15.1 .
<input type="checkbox"/>	Care for suspension seat post See Section 7.4.9.1 .
<input type="checkbox"/>	Care for rims See Section 7.4.10 .
<input type="checkbox"/>	Check rims See Section 7.5.1.3 .
<input type="checkbox"/>	Check rim hooks See Section 7.5.1.3 .
<input type="checkbox"/>	Care for fork See Section 7.4.2 .
<input type="checkbox"/>	Check gear shift See Section 7.5.15 .
<input type="checkbox"/>	Care for pannier rack See Section 7.4.3 .
<input type="checkbox"/>	Check chain See Section 7.5.14.1 .
<input type="checkbox"/>	Check derailleur gears see Section 7.5.14.1 and 7.5.15.3
<input type="checkbox"/>	Check chain tension see Section 7.5.4.1 and 7.5.4.2
<input type="checkbox"/>	Check wheel See Section 7.5.1 .
<input type="checkbox"/>	Care for handlebars See Section 7.4.7 .
<input type="checkbox"/>	Check handlebars See Section 7.5.12 .
<input type="checkbox"/>	Check light See Section 7.5.10 .
<input type="checkbox"/>	Care for hub See Section 7.4.12 .
<input type="checkbox"/>	Check hub See Section 7.5.14.2 .
<input type="checkbox"/>	Check nipple holes See Section 7.5.1.4 .
<input type="checkbox"/>	Care for pedals See Section 7.4.15 .
<input type="checkbox"/>	Check pedal. See Section 7.5.14 .
<input type="checkbox"/>	Care for frame See Section 7.4.1 .
<input type="checkbox"/>	Check belt tension See Section 7.5.9 .
<input type="checkbox"/>	Check saddle See Section 7.5.13 .
<input type="checkbox"/>	Care for shifter See Section 7.4.14.2 .
<input type="checkbox"/>	Care for rear derailleur articulated shaft See Section 7.4.14.1 .
<input type="checkbox"/>	Care for rear derailleur jockey wheels See Section 7.4.14.1 .
<input type="checkbox"/>	Care for kickstand See Section 7.4.5 .
<input type="checkbox"/>	Check kickstand stability See Section 7.5.19 .
<input type="checkbox"/>	Check steering headset See Section 8.5.6 .

Checklist: at least every six months (or every 1,000 km)	
<input type="checkbox"/>	Servicing the stem See Section 7.4.6 .
<input type="checkbox"/>	Checking the stem See Section 7.5.11 .

Checklist: Annual tasks (or every 2000 km)	
<input type="checkbox"/>	Adjust hub with cone bearing See Section 8.5.6 .
<input type="checkbox"/>	Check nipple well (every 1,000 hours or every 2,000 km) See Section 7.5.1.5 .

 **WARNING**
Crash caused by brake failure

Oil or lubricant on the brake disc in a disc brake or on the rim of a rim brake can cause the brake to fail completely. This may cause a crash with serious injuries.

- ▶ Never allow oil or lubricant to come into contact with the brake disc or brake linings or on the rim of a rim brake.
- ▶ If the brake linings have come into contact with oil or lubricant, contact specialist dealer to have the components cleaned or replaced.
- ▶ Apply the brakes a few times to test them after cleaning, servicing or repair.

The brake system is not designed for use on a pedelec which is placed on its side or turned upside down. The brake may not function correctly as a result. This can cause a crash, which may result in injuries.

- ▶ If the pedelec is placed on its side or turned upside down, apply the brakes a couple of times before setting off to ensure they work as normal.

The brake seals are unable to withstand high pressures. Damaged brakes can fail and cause an accident with injury.

- ▶ Never clean the pedelec with a pressure washer or compressed air.

Take great care when using a hosepipe. Never point the water jet directly at the seal section.

 **CAUTION**
Crash and falling caused by unintentional activation

There is a risk of injury if the electric drive system is activated unintentionally.

- ▶ Remove the battery before cleaning.

Notice

Water may enter the inside of the bearings if you use a steam jet. This dilutes the lubricant inside, the friction increases and, as a result, the bearings are permanently damaged in the long term. Water may also penetrate the electric components and damage them permanently.

- ▶ Never clean pedelec with a pressure washer, water jet or compressed air.

Greased parts, such as the seat post, the handlebars or the stem, may no longer be safely and reliably clamped.

- ▶ Never apply grease or oil to parts which are clamped

Harsh cleaning agents such as acetone, methylene and trichloroethylene and solvents such as thinners, alcohol and corrosion protection can attack pedelec components and damage them permanently.

- ▶ Use approved care and cleaning products only.

7.1 Before each ride

Complying with these cleaning instructions is the only way to reduce wear on components, increase the operating hours and guarantee safety.

7.1.1 Checking the guards

The chain or belt guards, mudguards or the motor cover can break and fall off when the pedelec is transported or parked outside.

- ▶ Check that all guards are in place.
- ▶ Take pedelec out of service if a guard is damaged or missing. Contact specialist dealer.

7.1.2 Checking the frame

- ▶ Check frame for cracks, warping and damage to the paintwork.
- ▶ If there are any cracks, warping or damage to the paintwork, remove the pedelec from service. Contact specialist dealer.

7.1.3 Checking the fork

- ▶ Check fork for cracks, warping, tarnished components, leaked oil and damage to the paintwork. Also look at hidden parts on the underside.
- ⇒ If there are any cracks, warping, tarnished components, leaked oil or damage to the paintwork, remove the pedelec from service. Contact specialist dealer.

7.1.4 Checking the rear frame damper

- ▶ Check rear frame damper for cracks, warping, tarnished components, leaked oil and damage to the paintwork. Also look at hidden parts on the underside.
- ⇒ If there are any cracks, warping, tarnished components, leaked oil or damage to the paintwork, remove the pedelec from service. Contact specialist dealer.

7.1.5 Checking the pannier rack

- 1 Hold onto pedelec by its frame. Hold onto pannier rack with the other hand.
- 2 Move the pannier rack backwards and forwards to check that all screw connections are firmly in place.
 - ⇒ Tighten loose screws.
 - ⇒ Attach loose baskets permanently with a basket bracket or cable ties.

7.1.6 Checking the mudguards

- 1 Hold onto pedelec by its frame. Hold onto mudguard rack with the other hand.
- 2 Move the mudguard backwards and forwards to check that all screw connections are firmly in place.
 - ⇒ Tighten loose screws.

7.1.7 Check wheel concentricity

- ▶ Lift the front and rear wheels one after the other and spin each wheel when lifted.
- ⇒ If the wheel is loose or crooked when it turns, take pedelec out of service. Contact specialist dealer.

7.1.8 Checking the quick releases

- ▶ Check quick releases to ensure that all quick releases are firmly in their fully closed end position.
- ⇒ If a quick release is not firmly in its closed end position, open quick release and place in its end position.
- ⇒ If the quick release cannot be firmly placed in its end position, take pedelec out of service. Contact specialist dealer.

7.1.9 Checking the suspension seat post

- ▶ Deflect and let the suspension seat post rebound.
- ⇒ If you hear unusual noises when the suspension seat post deflects and rebounds, or it yields without any resistance, take pedelec out of service. Contact specialist dealer.

7.1.10 Checking the bell

- 1 Press the bell button downwards.
 - 2 Let button spring back.
- ⇒ If you do not hear a clear, distinct ring of the bell, replace bell. Contact specialist dealer.

7.1.11 Checking the handles

- ▶ Check the handles are firmly in place.
- ⇒ Screw loose handles firmly into place.

7.1.12 Checking the USB cover

- ⇒ If featured, check the position of the *cover on the USB port* on a regular basis and adjust if necessary.

7.1.13 Checking the riding light

- 1 Switch light on.
 - 2 Check that the headlight and rear light come on.
- ⇒ If the headlight and rear lights do not come on, take pedelec out of service. Contact specialist dealer.

7.1.14 Checking the brake

- 1 Pull both handbrakes when stationary.
 - 2 Push the pedals.
- ⇒ If no resistance is generated in the handbrake's usual position, take pedelec out of service. Contact specialist dealer.
 - ⇒ If the brake is losing fluid, take pedelec out of service. Contact specialist dealer.

7.2 After each ride

Complying with these cleaning instructions is the only way to reduce wear on components, increase the operating hours and guarantee safety.

The following items should be ready for use to clean the pedelec after each ride:









Tool		Cleaning agent	
 Cloth	 Bucket	 Water	 Dish-washing liquid
 Brush	 Fork oil	 Silicone or Teflon oil	 Acid-free lubricating grease

Table 55: Required tools and cleaning agents after each ride

7.2.1 Cleaning the riding light and reflectors



- 1 Clean headlight, rear light and reflectors with a damp cloth.

7.2.2 Cleaning the suspension fork



- 1 Remove dirt and deposits from the stanchions and deflector seals with a damp cloth. Check the stanchions for dents, scratches, staining or leaking oil.
- 2 Lubricate the dust seals and stanchions with a few drops of silicone spray.
- 3 Service the suspension fork after cleaning.

7.2.3 Caring for the suspension fork



- Treat dust seals with fork oil.

7.2.4 Cleaning the pedals



- Clean pedals with a brush and soapy water.

7.2.5 Cleaning the brake



- Clean dirt on the rim and brake components with a slightly dampened cloth.

7.2.6 Cleaning the suspension seat post



- Clean dirt on the articulated joints with a slightly dampened cloth immediately after a ride.

7.2.7 Cleaning the rear frame damper



- Clean dirt on the articulated joints with a slightly dampened cloth immediately after a ride.

7.3 Basic cleaning

Complying with these basic cleaning instructions is the only way to reduce wear on components, increase the operating hours and guarantee safety.

The following are required for basic cleaning:

Tool		Cleaning agent	
 Gloves	 Toothbrush	 Water	 Lubricant
 Cloth	 Paintbrush	 Dish-washing liquid	 Brake cleaner
 Sponge	 Watering can	 Degreaser	 Leather cleaner
 Brushes	 Bucket		

Table 56: Required tools and cleaning agents for basic cleaning

- ✓ Remove battery and on-board computer before thorough cleaning.

7.3.1 Clean on-board computer and control panel



Notice

If water enters the on-board computer, it will be permanently damaged.

- ▶ Never immerse the on-board computer in water.
 - ▶ Never use a cleaning agent.
-
- ▶ Carefully clean the on-board computer and control panel with a soft, damp cloth.

7.3.2 Cleaning the battery



CAUTION

Risk of fire and explosion due to penetration by water

The battery is only protected from simple spray water. Penetration by water can cause a short circuit. The battery may self-ignite and explode.

- ▶ Keep contacts dry and clean.
- ▶ Never immerse the battery in water.

Notice

- ▶ Never use a cleaning agent.

- 1 Clean the battery electrical connections with a dry cloth or paintbrush only.
- 2 Wipe off the decorative sides with a damp cloth.

7.3.3 Cleaning the motor



Notice

If water enters the motor, it will be permanently damaged.

- ▶ Never open the motor.
 - ▶ Never immerse the motor in water.
 - ▶ Never use cleaning agents.
-
- ▶ Carefully clean the motor on the outside with a soft, damp cloth.

7.3.4 Clean Frame, fork, pannier rack, guards and kickstand



- 1 Soak the components with dish-washing detergent if the dirt is thick and ingrained.
- 2 After leaving it to soak for a short time, remove the dirt and mud with a sponge, brush and toothbrushes.
- 3 Rinse off the components with water from a watering can.
- 4 Wipe away oil stains with a degreaser.

7.3.5 Cleaning the stem



- 1 Clean stem with a cloth and soapy water.
- 2 Rinse off component with water from a watering can.

7.3.6 Cleaning the handlebars



- 1 Clean handlebars, including handles and all gears or twist grips, with a cloth and soapy water.
- 2 Rinse off component with water from a watering can.

7.3.7 Clean handles



- 1 Clean handles with sponge, water and soapy water.
- 2 Rinse off component with water from a watering can.
- 3 Care for rubber handles after cleaning (see Section [7.4.8](#)).

7.3.7.1 Cleaning leather handles



Leather is a natural product and has similar properties to human skin. Regular cleaning and care help to prevent leather dehydrating, fading or becoming brittle or stained.

- 1 Remove dirt with a soft, damp cloth.
- 2 Remove stubborn stains with a leather cleaner.
- 3 Care for leather handles after cleaning (see Section [7.4.8.2](#)).

7.3.8 Clean seat post



- 1 Clean seat post with a cloth and soapy water.
- 2 Rinse off component with water from a watering can.
- 3 Wipe away any grease or assembly paste residue with a cloth and degreaser.

7.3.9 Cleaning the saddle



- 1 Clean the saddle with lukewarm water and a cloth dampened with soapy water.
- 2 Rinse off component with water from a watering can.

7.3.9.1 Cleaning the leather saddle

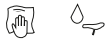

Leather is a natural product and has similar properties to human skin. Regular cleaning and care help to prevent leather dehydrating, fading or becoming brittle or stained.

- 1 Remove dirt with a soft, damp cloth.
- 2 Remove stubborn stains with a leather cleaner.
- 3 Care for leather saddle after cleaning (see Section [7.4.11](#)).

7.3.10 Cleaning the tyres



- 1 Clean tyres with a sponge, a brush and soap cleaner.
- 2 Rinse off component with water from a watering can.
- 3 Remove any embedded chips and small stones.

7.3.11 Cleaning the spokes and spoke nipples

- 1 Clean spokes from the inside to the outside with a sponge, brush and soapy water.
- 2 Clean rim with a sponge.
- 3 Rinse off component with water from a watering can.
- 4 Care for spoke nipples after cleaning (see Section [7.4.13](#)).

7.3.12 Clean hub



- 1 Put on protective gloves.
- 2 Remove dirt from hub with a sponge and soapy water.
- 3 Rinse off component with water from a watering can.
- 4 Wipe off oily dirt with a degreaser and a cloth.

7.3.13 Cleaning the switching elements



- 1 Clean gear shift and shift cables with water, a brush and dish-washing detergent.
- 2 Rinse off component with water from a watering can.

7.3.13.1 Cleaning the shifter



- Carefully clean shifter with a damp, soft cloth.

7.3.14 Clean cassette, chain wheels and front derailleur



- 1 Put on protective gloves.
- 2 Spray cassette, chain wheels and front derailleur with degreasing agent.
- 3 Clean coarse dirt with a brush after soaking for a short time.
- 4 Wash down all parts with dish-washing detergent and a toothbrush.
- 5 Rinse off component with water from a watering can.

7.3.15 Clean brake

7.3.15.1 Clean handbrake



- ▶ Carefully clean the handbrake with a damp, soft cloth.

7.3.16 Cleaning the brake disc



Notice

- ▶ Protect brake disc against lubricants and grease from hands.

- 1 Put on protective gloves.
- 2 Spray brake disc with brake disc cleaning spray.
- 3 Wipe with a cloth.

7.3.17 Cleaning the belt



Notice

- ▶ Never use aggressive (acid-based) cleaners, rust removers or degreasers when cleaning the belt.

- 1 Dampen a cloth with soapy water. Place the cloth on the belt.
- 2 Hold and apply slight pressure while slowly turning the rear wheel so that the belt passes through the cloth.

7.3.18 Cleaning the chain



Notice

- ▶ Never use aggressive (acid-based) cleaners, rust removers or degreasers when cleaning the chain.
- ▶ Never use gun oil or rust remover spray.
- ▶ Never use chain cleaning devices or chain cleaning baths.
- ▶ Have chain with all-round guard cleaned and cared for during major inspection.

- ✓ Place newspaper or paper towels underneath to collect dirt.

- 1 Slightly dampen a brush with dish-washing liquid. Brush both sides of the chain.
- 2 Dampen a cloth with soapy water. Place the cloth on the chain.
- 3 Hold and apply slight pressure while slowly turning the rear wheel, so the chain passes through the cloth.
- 4 Wipe off oily, dirty chains thoroughly with a cloth and degreaser.
- 5 Care for the chain after cleaning (see Section [7.4.16](#)).

7.3.18.1 Clean chain, including all-round chain guard



Notice

The chain guard must be removed before cleaning. Contact specialist dealer.

- ▶ Clean water hole on the chain guard lower surface.
- ▶ Care for the chain after cleaning (see Section [7.4.16.1](#)).

7.4 Servicing

Complying with these servicing instructions is the only way to reduce wear on components, increase the operating hours and guarantee safety.

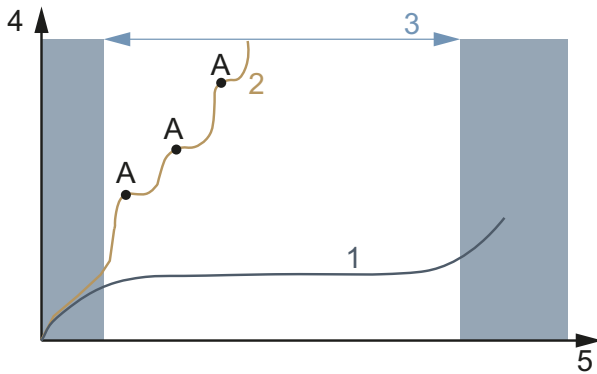

Figure 158: Diagram showing wear, operating hours (x) vs. material abrasion (y)

The service life (3) of an optimally serviced drive chain (1) is almost three times as long with lubrication (A) compared to a drive chain (2) lubricated on an irregular basis.

These tools and cleaning agents are required for servicing:











Tool		Cleaning agent	
 Cloth	 Toothbrush	 Frame wax spray	 Silicone or Teflon oil
		 Acid-free lubricating grease	 Fork oil
		 Teflon spray	 Spray oil
		 Chain oil	 Leather care product

Table 57: Required tools and cleaning agents for servicing

		 Battery terminal grease	
--	--	--	--

Table 57: Required tools and cleaning agents for servicing

7.4.1 Frame



Notice

- ▶ Hard wax polish and protection wax are particularly resistant on gloss paintwork. These car accessory retail products are unsuitable for matt paint finishes.
- ▶ Try wax spray out on a small spot before application.

- 1 Dry frame with a cloth.
- 2 Spray frame with spray wax and leave to dry.
- 3 Wipe away any wax residue with a cloth.

7.4.2 Fork



Notice

- ▶ Hard wax polish and protection wax are particularly resistant on gloss paintwork. These car accessory retail products are unsuitable for matt paint finishes.
- ▶ Try wax spray out on a small spot before application.

- 1 Dry fork with a cloth.
- 2 Spray frame care oil on frame and leave to dry.
- 3 Wipe away any wax residue with a cloth.

7.4.3 Pannier rack

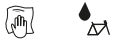

- 1 Dry pannier rack with a cloth.
- 2 Spray pannier rack with spray wax and leave to dry.
- 3 Wipe pannier rack with a cloth.
- 4 Protect chafing points on panniers with adhesive film. Replace worn adhesive film.
- 5 Care for coil springs with silicone spray or wax spray from time to time.

7.4.4 Mudguard



- ▶ Depending on the requirements for the material in the mudguard, apply hard wax polish, metal polish or a plastic care product as per the product instructions.

7.4.5 Servicing the kickstand



- 1 Dry kickstand with a cloth.
- 2 Spray kickstand rack with spray wax and leave to dry.
- 3 Wipe down kickstand with a cloth.
- 4 Lubricate the kickstand joints with spray oil.

7.4.6 Stem



- 1 Spray painted and polished metal surfaces with wax spray and leave to dry.
- 2 Wipe away any wax residue with a cloth.
- 3 Apply silicone or Teflon oil to the stem shaft tube and the quick release lever pivot point with a cloth.

- 4 If you have a Speedlifter Twist, also apply oil to the unlocking bolt groove in the Speedlifter body.
- 5 Apply a little acid-free lubricant grease between the stem quick release lever and the sliding piece to reduce the quick release lever operating force.
- 6 If you have a stem with a cone clamp, apply a new protective layer of assembly paste onto the stem and fork steerer contact point once a year.

7.4.7 Handlebars



- 1 Spray painted and polished metal surfaces with wax spray and leave to dry.
- 2 Wipe away any wax residue with a cloth.

7.4.8 Handle

7.4.8.1 Rubber handles

- 1 Apply talcum powder to sticky rubber handles.

Notice

- ▶ Never apply talcum powder to leather or foam handles.

7.4.8.2 Leather handle



Standard leather care products keep leather smooth and resistant, brighten its appearance and improve or replace stain protection.

- 1 Try leather care product out on a less visible spot before use.
- 2 Care for leather handles with a leather care product.

7.4.9 Seat post

- 1 Carefully preserve screw connections with wax spray. In doing so, ensure that no wax is applied to the metal contact surfaces.
- 2 Replace the assembly paste protective layer on the metal contact surfaces on the seat post and seat tube every year.

7.4.9.1 Suspension seat post



- 1 Lubricate articulated joints with spray oil.
- 2 Deflect and let the suspension seat post rebound five times. Remove any surplus lubricant with a clean cloth.

7.4.9.2 Carbon seat post



Notice

Rain and puddle water can cause contact corrosion if carbon seat posts are used in an aluminium frame without protective assembly paste. It may then take a great deal of force to remove the seat post. The carbon seat post may break as a result.

- 1 Take out the carbon seat post.
- 2 Remove old assembly paste with a cloth.
- 3 Apply new assembly paste with a cloth.
- 4 Re-insert the carbon seat post.

7.4.10 Rim



- Care for chrome rims, stainless steel rims and polished aluminium with chrome or metal polish. Never care for the brake surface with polish.

7.4.11 Leather saddle



Standard leather care products keep leather smooth and resistant, brighten its appearance and improve or replace stain protection.

- 1 Try leather care product out on a less visible spot before use.
- 2 Care for leather saddle from below with a leather care product. Only care for the top of leather saddles with a leather care product if they are badly worn and dried-out.
- 3 Avoid wearing light-coloured trousers after care due to staining.

7.4.12 Hub



- 1 Apply wax spray especially around the spoke holes. In doing so, ensure that no wax is applied to brake parts.
- 2 Treat rubber seals with a cloth with one or two drops of silicone spray. Never use oil if you have disc brakes.

7.4.13 Spoke nipples



- 1 Apply wax spray onto the spoke nipples from the rim side.
- 2 Treat heavily corroded spoke nipples with a drop of penetrating of special care oil.

7.4.14 Gear shift

7.4.14.1 Rear derailleur articulated shafts and jockey wheels



- ▶ Treat front and rear derailleur articulated shafts and jockey wheels with Teflon spray.

7.4.14.2 Shifter



Notice

- ▶ Never treat shifters with degreaser or penetrating oil spray.
- ▶ Lubricate articulated joints and mechanical parts which are accessible from outside with a few drops of spray oil or precision mechanics oil.

7.4.15 Pedal



- 1 Treat pedals with spray oil. In doing so, ensure that no lubricant is applied to the pedal surfaces.
- 2 Lubricate seals and mechanical parts sparingly with a few drops of oil.
- 3 Remove any surplus lubricant with a clean cloth.
- 4 Spray metal foot rests with silicone spray.

7.4.16 Caring for the chain



- ✓ Place newspaper or paper towels underneath to collect chain oil.
- 1 Lift rear wheel.
 - 2 Turn the crank briskly in an anti-clockwise direction.
 - 3 Use slight finger pressure to the chain oil bottle to apply a wafer-thin thread of oil to the chain links. The faster the crank is turned, the thinner the threads of oil will be.

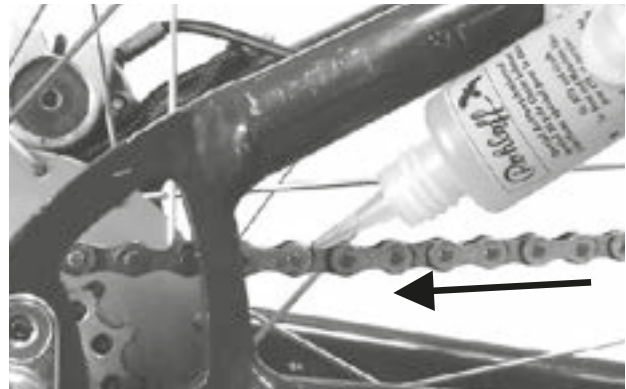

Figure 159: Lubricating the chain

- 4 Remove excessive chain oil with a cloth. If you apply too much oil, it will make the chain all the dirtier at a later point in time.
- 5 Leave chain oil to penetrate into the chain links for a few hours or overnight.

7.4.16.1 Caring for the chain and all-round chain guard



- ✓ Place newspaper or paper towels underneath to collect chain oil.
- 1 Lift rear wheel.
- 2 Turn the crank briskly in an anti-clockwise direction.
- 3 Use slight finger pressure to the chain oil bottle to apply a wafer-thin thread of oil onto the chain links through the oil hole on the upper surface of the chain guard. The faster the crank is turned, the thinner the threads of oil will be.
- 4 Remove excessive chain oil with a cloth. If you apply too much oil, it will make the chain all the dirtier at a later point in time.
- 5 Leave chain oil to penetrate into the chain links for a few hours or overnight.

7.4.17 Caring for the battery



- ▶ Grease plug terminals on the battery with terminal grease or contact spray from time to time.

7.4.18 Caring for the brake

7.4.18.1 Caring for handbrake



Notice

- ▶ Never treat brake handbrake with degreaser or penetrating oil spray.
- ▶ Lubricate articulated joints and mechanical parts which are accessible from outside with a few drops of spray oil or precision mechanics oil.

7.4.19 Lubricating the Eightpins seat post tube

- ▶ Use a 2.5 ml syringe to carefully fill Eightpins Fluid V3 very slowly into the lubricating nipple on the outer tube.



Figure 160: Lubricating the eightpins seat post

Notice

- ▶ Fill a maximum of 2.5 ml since otherwise the reservoir inside will overflow and the oil will spill into the frame.

7.5 Inspection

The following tools are required for an inspection:







	Gloves
	Ring spanners 8 mm, 9 mm, 10 mm, 13 mm, 14 mm and 15 mm
	Torque spanner Working range 5–40 Nm
	by.schulz handlebars: TORX® bits: T50, T55, and T60
	Hex key 2 mm, 2.5 mm, 3 mm, 4 mm, 5 mm, 6 mm and 8 mm
	Phillips screwdriver
	Slotted-head screwdriver

Table 58: Tools required for maintenance

7.5.1 Checking the wheel

- 1 Hold pedelec.
- 2 Hold onto the front or rear wheel and try to move the wheel sideways. In doing so, check to see if the wheel nuts or quick releases move.
 - ⇒ If the wheel moves or the wheel nut or quick release moves sideways, take pedelec out of service. Contact specialist dealer.
- 3 Lift pedelec slightly. Turn front or rear wheel. In doing so, check whether the wheel deflects sideways or outwards.
 - ⇒ If the wheel deflects sideways or outwards, take pedelec out of service. Contact specialist dealer.

7.5.1.1 Checking tyre pressure

Notice

If the tyre pressure is too low in the tyre, the tyre does not achieve its load bearing capacity. The tyre is not stable and may come off the rim.

If the tyre pressure is too high, the tyre may burst.

Tyres are wear parts and wear away due to fatigue, storage, environmental influences or mechanical impacts. Only optimum tyre pressure will guarantee greater safety, lower rolling resistance, effective protection against punctures and a longer service life.

Air loss

Even the most airtight tube will lose pressure on a continuous basis since the air pressures in a pedelec tyre are significantly higher and the wall thicknesses significantly finer than in a car tyre. Pressure loss of 1 bar per month can be regarded as normal. During this process, the pressure loss is significantly faster at high pressures and significantly slower at low pressures.

Checking tyre pressure

The permitted pressure range is indicated on the side of the tyre.



Figure 161: Tyre pressure in bar (1) and psi (2)

- ▶ Verify tyre pressure against the value noted in the pedelec pass every 10 days as a minimum.

Dunlop valve**Only applies to pedelecs with this equipment**

The tyre pressure cannot be measured on the simple Dunlop valve. You thus measure the tyre pressure in the filling hose while slowly pumping the bicycle air pump.

- ✓ It is recommendable to use a bicycle air pump with a pressure gauge.
 - 1 Unscrew and remove the valve cap.
 - 2 Undo the rim nuts.
 - 3 Connect the bicycle air pump.
 - 4 Pump up the tyre slowly and pay attention to the tyre pressure in the process.
 - 5 Correct the tyre pressure to meet the specified value in the Pedelec pass.
 - 6 If the tyre pressure is too high, unfasten the union nut, let air out and re-tighten the union nut.
 - 7 Remove the bicycle air pump.
 - 8 Screw the valve cap tight.
 - 9 Screw the rim nut gently against the rim with the tips of your fingers.
- ⇒ Correct tyre pressure if necessary (see section [6.5.8](#)).

Schrader valve**Only applies to pedelecs with this equipment**

- ✓ It is recommended to use an air pump at a filling station or a modern bicycle air with a pressure gauge. Older and simple bicycle air pumps are unsuitable for filling tyres via a Schrader valve.
 - 1 Unscrew and remove the valve cap.
 - 2 Undo the rim nuts.
 - 3 Connect the bicycle air pump.
 - 4 Pump up the tyre slowly and pay attention to the tyre pressure in the process.
- ⇒ The tyre pressure has been adjusted as per the specifications.

- 5 Remove the bicycle air pump.
 - 6 Screw the valve cap tight.
 - 7 Screw the rim nut gently against the rim with the tips of your fingers.
- ⇒ Correct tyre pressure if necessary (see section [6.5.8](#)).

Presta valve**Only applies to pedelecs with this equipment**

- ✓ It is recommendable to use a bicycle air pump with a pressure gauge. You must observe the bicycle air pump operating instructions.
 - 1 Unscrew and remove the valve cap.
 - 2 Open the knurled nut around four turns.
 - 3 Carefully attach the bicycle air pump so that you do not bend the valve insert.
 - 4 Pump up the tyre slowly and pay attention to the tyre pressure in the process.
 - 5 Correct the tyre pressure as per the specifications on the tyre.
 - 6 Remove the bicycle air pump.
 - 7 Tighten the knurled nut with your fingers.
 - 8 Screw the valve cap tight.
 - 9 Screw the knurled nut gently against the rim with the tips of your fingers.
- ⇒ Correct tyre pressure if necessary (see section [6.5.8](#)).

7.5.1.2 Checking the tyres

The tread is far less important for bicycle tyres than it is for car tyres, for example. Consequently, tyres can still be used with a worn tread with the exception of tyres on mountain bikes.

- 1 Check the tread for wear. The tyre is worn if the anti-puncture protection or the carcass cords are visible.

Since resistance to punctures also depends on the thickness of the tread, it may make sense to change the tyre at an earlier stage.



Figure 162: Tyre without tread which can be replaced (1) and tyre with puncture protection showing through (2), which must be replaced

- 2 Check the side walls for wear. If there are any cracks or tears, the tyre must be replaced.



Figure 163: Examples of fatigue cracks (1) and ageing cracks (2)

- ⇒ Replacing a wheel requires considerable mechanical expertise. If a tyre is worn, it needs to be replaced at a specialist dealer's.

7.5.1.3 Checking the rims



Crash caused by a worn rim

A worn rim can break and block the wheel. This may cause a crash with serious injuries.

- ▶ Check *Wear* on rim on a regular basis.
- ▶ Take pedelec out of service if the rim has any cracks or warping. Contact specialist dealer.

Rims are wear parts and wear away due to fatigue, mechanical impacts, environmental influences or due to braking if rim brakes are used.

- ▶ Check the rim well for wear.
- ⇒ The rims of a rim brake with invisible wear indicator are worn as soon as the wear indicator becomes visible in the area of the rim joint.
- ⇒ The rims with visible wear indicator are worn as soon as the black, all-round groove on the pad friction surface is no longer visible.
- ▶ We recommend that you also replace the *rims* at the same time as every second brake lining replacement.

7.5.1.4 Checking the nipple holes

Nipples cause fatigue and stress on the edge of the nipple hole.

- ▶ Check whether there are cracks on the edge of the nipple hole.

If there are cracks on the edge of the nipple hole, contact your specialist dealer.

7.5.1.5 Checking the nipple well

The nipple holes can weaken the tyre bed.

- ▶ Check to see if cracks are emerging from the nipple holes.
- ⇒ If there are cracks radiating from the nipple hole, contact your specialist dealer.

7.5.1.6 Checking the rim hooks

Mechanical impacts can warp the rim hooks. There is no longer a guarantee that a tyre can be fitted safely if this is the case.

- ▶ Check for twisted rim hooks.
- ⇒ Replace rims with twisted rim hooks. Never repair the rim with pliers and bend the hook back.

7.5.1.7 Checking the spokes

- ▶ Press spokes slightly together with your thumb and index finger. Check to ensure that the tension is the same for all spokes.
- ⇒ Contact your specialist dealer if the spokes are loose or are tensioned differently.

7.5.2 Checking the brake system



Crash caused by brake failure

Worn brake discs and brake linings and a lack of hydraulic fluid in the brake cable reduce the braking power. This may cause a crash with serious injuries.

- ▶ Check brake disc, brake linings and the hydraulic brake system regularly. Contact specialist dealer.

The maintenance interval for the brake depends on how often it is used and the weather conditions. If the pedelec is used under extreme conditions such as rain, dirt or high mileage, maintenance must be performed more frequently.

7.5.2.1 Checking the handbrake

- 1 Check that all screws in the handbrake are firmly in place.
 - ⇒ Tighten loose screws.
- 2 Check that handbrake is torsionally rigid on the handlebars.
 - ⇒ Tighten loose screws.
- 3 Check that there is a gap of at least 1 cm between the handbrake and the handle when the handbrake is fully applied.
 - ⇒ Adjust the grip distance if the gap is too narrow (see Section [6.5.9.5](#), Section [6.5.10.1](#) or Section [6.5.9.4](#)).
- 4 Check the braking effect by pedalling while pulling the handbrake.
 - ⇒ If the braking power is too weak, adjust the brake pressure point (see Section [6.5.9.8](#)).
 - ⇒ Contact your specialist dealer if the pressure point cannot be reached.

7.5.2.2 Checking the hydraulic brake system

- 1 Pull on the handbrake and check whether any brake fluid leaks out of the lines, connections or on the brake linings.
 - ⇒ If any brake fluid leaks from anywhere, take pedelec out of service. Contact specialist dealer.
- 2 Pull brake handbrake and hold several times.
 - ⇒ If you are unable to clearly detect the pressure point and it changes, the brake needs to be bled. Contact specialist dealer.

7.5.2.3 Checking the Bowden cables

- 1 Pull on handbrake several times. Check whether the Bowden cables get stuck or they make scraping noises.
- 2 Check the physical condition of the Bowden cables for visible damage and check to see if wire strands are broken.
 - ⇒ Have defective Bowden cables replaced. Contact specialist dealer.

7.5.2.4 Checking the disc brake

Only applies to pedelecs with this equipment

Checking the brake linings

- ▶ Check that the brake linings are no less than 1.8 mm wide at any point and there are no less than 2.5 mm between the brake lining and supporting plate.



Figure 164: Checking the brake lining when fitted with the help of the transport safety wear gauge

- 1 Check brake linings for damage and thick dirt.
 - ⇒ Have damaged or very dirty brake linings replaced. Contact specialist dealer.
- 2 Pull handbrake and hold.
- 3 In doing so, check whether the transport safety wear gauge can fit between the brake lining supporting plates.
 - ⇒ If the transport safety wear gauge fits between the supporting plates, the brake linings have not reached their wear limit. Contact your specialist dealer if they are *Wear*.

Checking the brake discs

- ✓ Put on gloves as the brake disc is very sharp.
- 1 Take hold of brake disc and wiggle it gently to check whether the brake disc is positioned against the wheel free of backlash.
 - 2 Check that the brake linings move steadily and symmetrically back towards the brake disc when you pull and release handbrake.
 - ⇒ If the brake disc can be moved or the brake linings move erratically, contact your specialist dealer.
 - 3 Check that the brake disc is no less than 1.8 mm thick at any point.
 - ⇒ If the brake disc is under the wear limit and is less than 1.8 mm thick, the brake disc must be replaced. Contact specialist dealer.

7.5.2.5 Checking the back-pedal brake

Only applies to pedelecs with this equipment

- ✓ There are sharp corners and edges on the back-pedal brake. Wear gloves.
- 1** Hold and check counter support to ensure it is firmly attached to rear frame down tube.
 - ⇒ Tighten screw into the counter support if it is loose.
- 2** Carry out brake test. Listen for noises while doing so.
 - ⇒ If braking with the backpedal makes noises, contact specialist dealer.

7.5.2.6 Checking the rim brake

Only applies to pedelecs with this equipment

Checking the brake linings

- ▶ We recommend that you also replace the *rim*s at the same time as every second brake lining replacement.
- 1 Check whether the brake linings are worn evenly on both sides of the rim. Check whether the brake linings are worn to one side.
 - ⇒ If the brake linings are worn unevenly or worn to one side, contact your specialist dealer.
- 2 Check whether the brake lining wear limit has been reached.
 - ⇒ If the brake linings have reached their wear limit, they need to be changed. Contact specialist dealer.
- 3 Check whether the brake linings can be twisted.
 - ⇒ If the brake linings twist, the brake lining bracket is defective and must be replaced. Contact specialist dealer.
- 4 Check that the brake linings move steadily and symmetrically back towards the rim when you pull and release the handbrake.
 - ⇒ If the brake linings move irregularly, contact your specialist dealer.

Checking the rim braking surface for wear

The side wall is more prone to wear in rim brakes. The Wear depends on the stress loads during rides. Dirt between the brake lining and rim and strong braking forces can have an impact on the service life.

The rim must be replaced if the wall is less than 0.9 mm thick. If deep grooves are visible, rim hooks will warp towards the outside or the braking power will change, contact your specialist dealer as soon as possible.

- ▶ Replacing a rim requires considerable mechanical expertise. Only a specialist dealer should carry out this task.

Adjusting the V-brake

- ▶ Check that the braking effect initiates after one third of the handbrake distance is reached.
 - ⇒ Turn the setting screw on the brake handle to the left and right to adjust the gap between the brake shoes and the rim uniformly to 1-1.5 mm.
 - ⇒ If the brake handle has no setting screw or the gap between the brake shoes and the rim can only be set above 1.5 mm, contact your specialist dealer.

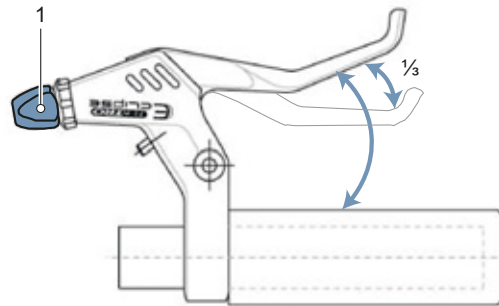

Figure 165: Turn setting screw (1) until brakes initiate after $\frac{1}{3}$ of the handbrake distance is reached

7.5.3 Checking the chain

- ▶ Check chain for rust, damage and chain links that are difficult to move.
- ⇒ Replace rusted, damaged or difficult-to-move chains since they will not withstand the tensile loads from the drive and will soon break. Contact specialist dealer.

7.5.4 Checking the chain tension

Notice

Excessive chain tension increases wear. If the chain tension is too low, there is a risk that the *chain* will slip off the *chain wheels*.

- ▶ Check the chain tension once a month.

7.5.4.1 Check tension in derailleur gears

The rear derailleur tensions the chain on pedelecs with derailleur gears.

- 1 Check to see if the chain is sagging.
 - 2 Gently press the rear derailleur forwards to check whether it moves and whether it goes back into position by itself.
- ⇒ If the chain is sagging or the rear derailleur does not go back into position by itself, contact your specialist dealer.

7.5.4.2 Check tension in hub gear

Remove the chain guard on pedelecs with a circumferential chain guard.

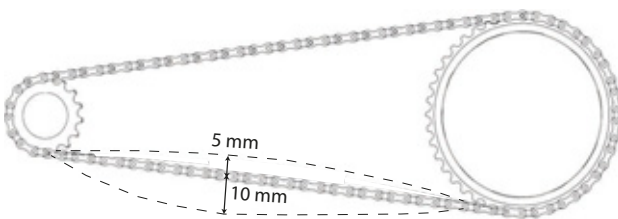

Figure 166: Checking the chain tension (example): 5 mm upwards, 10 mm downwards = 15 mm deviation

- 1 Lift chain upwards. Measure the distance to the centre. Press chain downwards. Measure the distance to the centre.

- 2 Add the two values together to calculate the deviation.
- 3 Check the chain tension at three to four points.
 - ⇒ If the deviation is greater than 20 mm, tighten chain.
 - ⇒ If the deviation is less than 10 mm, Loosen chain.
- ▶ If a hub gear is fitted, the rear wheel must be pushed backwards and forwards to tighten the chain. Contact specialist dealer.
- ▶ In the case of pedelecs with a hub gear or back-pedal brake, the chain is tensioned by an eccentric bearing or movable fork end in the bottom bracket axle. Special tools and specialist knowledge are required to tension the chain. Contact specialist dealer.

7.5.5 Checking the belt for wear

Each chain has a wear limit. If this limited is exceeded, the chain needs to be replaced.

Manufacturer	Wear limits
SHIMANO	>1%
KCM	>0.8 mm per link
SRAM	>0.8%
ROHLOFF	S: >0.1 mm per link A: >0.075 mm per link

Table 59: Chain wear limit by manufacturer

7.5.5.1 Rough check

You can perform a rough check on the chain wheel by hand on conventional chains

- 1 Place the chain on the largest chain wheel.
 - 2 Lift the chain from the front to the centre of the bike.
- ⇒ If the chain can be lifted more than half a link from the chain wheel, carry out a check or contact your specialist dealer.

7.5.5.2 Check

There is a different wear gauge for each chain, depending on the manufacturer:



Figure 167: Example of a KMC gauge



Figure 168: Example of a SHIMANO gauge

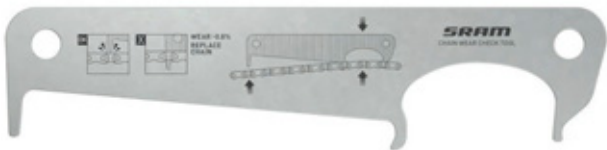

Figure 169: Example of a SRAM gauge



Figure 170: Example of a ROHLOFF gauge



Figure 171: Example of a KMC digital gauge

1 Insert gauge between two chain links on the right-hand side.

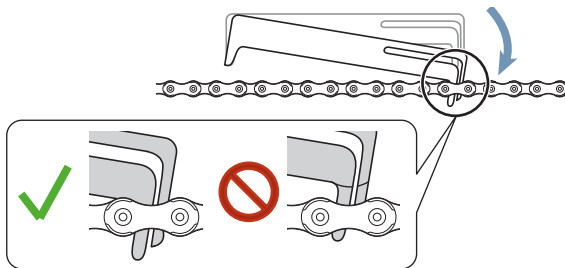

Figure 172: Gauge is inserted

2 Lower gauge down to the left-hand side.

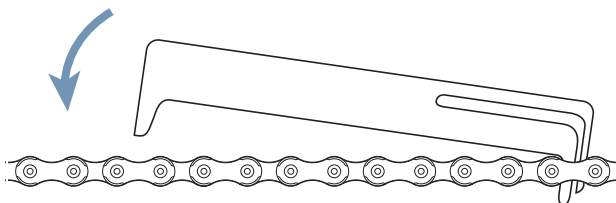

Figure 173: Lower gauge to the left

⇒ If the gauge does not fit between the links, the chain is not worn yet.

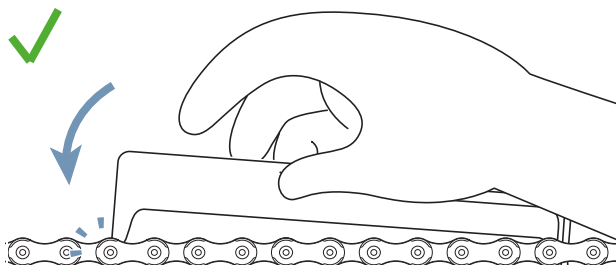

Figure 174: Gauge does not fit

⇒ If the gauge does not fit between the links, the chain is worn and must be replaced. Contact specialist dealer.

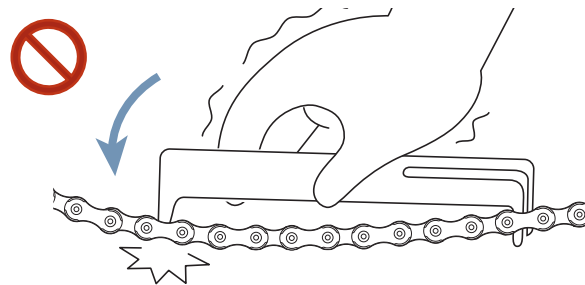

Figure 175: Gauge fits

7.5.6 Checking the belt

7.5.7 Checking the belt for wear

► Check belt for indications of wear:

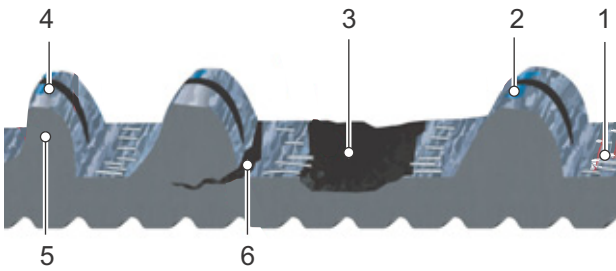

Figure 176: Indications of wear on a belt

- 1 Carbon tensile fibres are exposed
- 2 Worn webbing with visible polymer
- 3 Missing belt tooth
- 4 Imbalance
- 5 Shark tooth
- 6 Cracks

⇒ If there is one or more indications of wear, replace belt. Contact specialist dealer.

7.5.8 Checking the belt sprockets for wear

► Check belt sprocket.

⇒ The tooth profile is rounded and the teeth are thick. The belt drive sprocket does not need to be replaced.

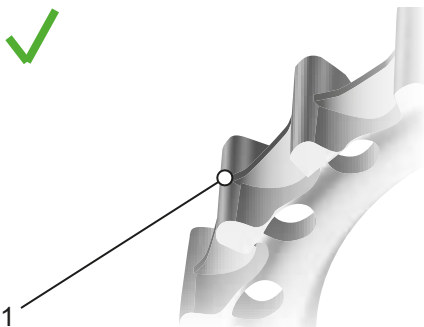

Figure 177: Optimum tooth profile

⇒ The tooth profile is pointed and teeth have worn thinner. Replace belt sprocket. Contact specialist dealer.

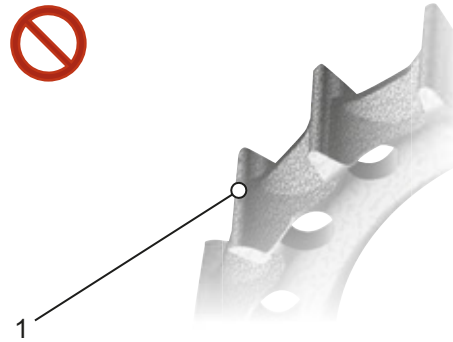

Figure 178: Worn tooth profile

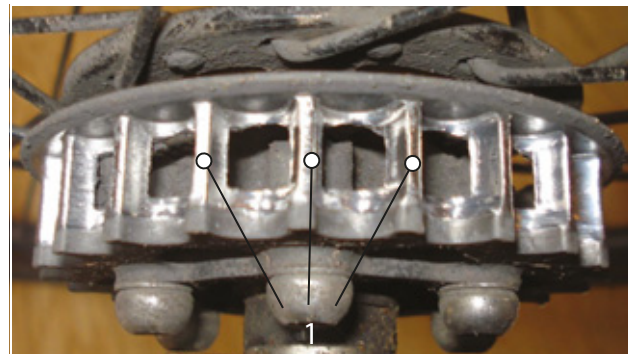

Figure 179: Photo showing example of worn tooth profile

7.5.9 Check belt tension

If the belt tension is too low, this can cause the system to miss out a tooth or slip, i.e. the teeth on the belt slip over the teeth on the rear wheel belt sprocket. Excessive tension can cause damage to the bearings, sluggishness in the system and increased wear on the electric drive system.

The adjustment of the belt tension varies depending on the pedelec. Common tensioning systems include angled or vertical drop-outs, horizontally sliding dropouts and eccentric bottom brackets.

There are three common methods of measuring belt tension:

- Gates Carbon Drive mobile app for iPhone® and Android®,
- Gates Krikkit tension meter and
- Eco tension tester.

With any of these methods, the tension along the belt may vary slightly, so you should repeat the process several times. Turn the pedal a quarter after each measurement. Measure again.

The tools measure the tension only. They do not provide specifications for the required voltage. The table below contains specifications for the correct tensioning range for Gates Carbon Drive belts.

	Steady pedalling	Sports Use
MTBs* and single-speed bicycles	45– 60 Hz (35– 45 lbs)	60– 75 Hz (45– 53 lbs)
Hub gear/pinion gear	35– 50 Hz (28– 40 lbs)	

Table 60: Specifications for tensioning

* The CDN and SideTrack systems are not permitted for mountain bikes, e-bikes with mid-drive motor or gears, bikes without a gear shift or for trekking or touring bikes.

These tension specifications are designed as initial guidance and may have to be corrected upwards or downwards depending on the body size, gear ratio and the force applied to the pedals.

7.5.9.1 Gates Carbon Drive mobile app



The Gates Carbon Drive mobile app measures the belt tension based on the belt's natural frequencies (Hz). To do so, the app uses the phone's mic to record the sound of the belt and

determines the main frequency.

- ✓ Download Gates Carbon Drive mobile app free of charge from the App Store or Google Play on your mobile phone.
- ✓ Measure in a quiet environment.
- ✓ Ensure that the phone microphone is switched on.

- 1 Open app.
 - 2 Click on the voltage symbol.
 - 3 Click on MEASURE.
 - 4 Point phone microphone towards the belt.
 - 5 Pluck the belt so that the belt vibrates like a guitar string.
 - 6 It is recommended to take several measurements for comparison. Turn the crank a quarter. Repeat frequency measurement.
 - 7 Check the belt frequency displayed against the specifications for tensions in Table 44.
- ⇒ If the value is higher than the specification, reduce belt tension,
- ⇒ If the value is within the specified range, the belt tension has been correctly adjusted.
- ⇒ If the value is lower than the specification, increase belt tension.

7.5.9.2 Gates Kriket tension meter Not included in price

- ✓ Check that the measurement indicator is at the very bottom.

- 1 Extend index finger into the finger loop. Place on the check gauge.

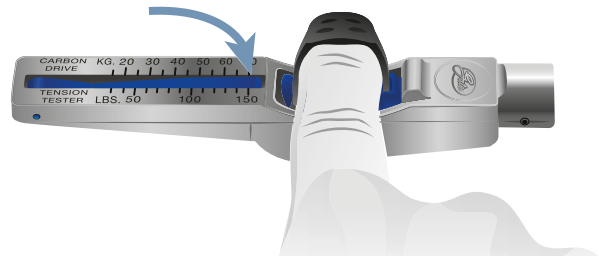

Figure 180: Index finger in the check gauge

- 2 Position check gauge on the upper surface of the belt. Position check gauge in the middle of the belt length.

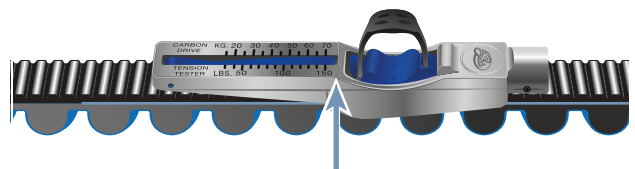

Figure 181: Check gauge on belt

- 3 Press the check gauge down with just one finger until it clicks into place.

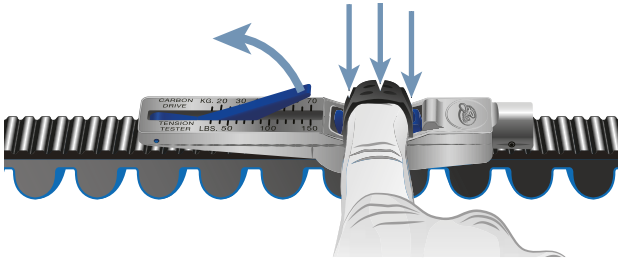

Figure 182: Pressing the check gauge down with one finger

- 4 Take reading where line A meets line B.

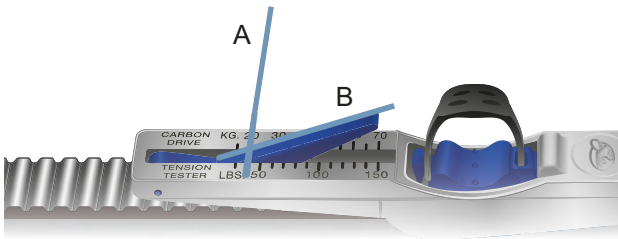

Figure 183: Example of a reading: 20 kg

- 5 Turn the pedal a quarter. Repeat measurement at least three times.
- 6 Convert value read from kg and into pounds and inch per pound.
Example: 20 kg = 44 In = 44 lbs
- 7 Compare value with Table 44 Tension specification.
 - ⇒ If the value is higher than the specification, reduce belt tension,
 - ⇒ If the value is within the specified range, the belt tension has been correctly adjusted.
 - ⇒ If the value is lower than the specification, increase belt tension.

7.5.9.3 ECO tension tester

Not included in price

- 1 Attach the measuring stick on the belt.

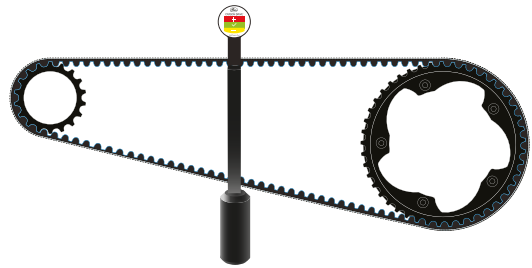

Figure 184: Attached measuring stick

- 2 Place the ruler on both belt sprockets.



Figure 185: Ruler in place

- ⇒ Read tension on the tension indicator.

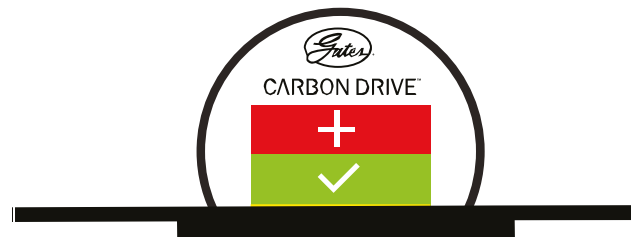

Figure 186: Example: On yellow along lower edge, so reduce belt tension slightly

- Red = increase belt tension
- Green = belt tension is set correctly
- Yellow = reduce belt tension

7.5.10 Checking the riding light

- 1 Check the cable connections on the headlight and rear light for damage and corrosion and ensure they are firmly in position.
- ⇒ If cable connections are damaged or corroded, or are not firmly in positioned. take pedelec out of service. Contact specialist dealer.
- 2 Switch light on.
- 3 Check that the headlight and rear light come on.
- ⇒ If the headlight or rear lights do not come on, take pedelec out of service. Contact specialist dealer.
- 4 Place pedelec 5 m from the wall.
- 5 Stand the pedelec up straight. Hold the handlebars straight with both hands. Do not use the kickstand.

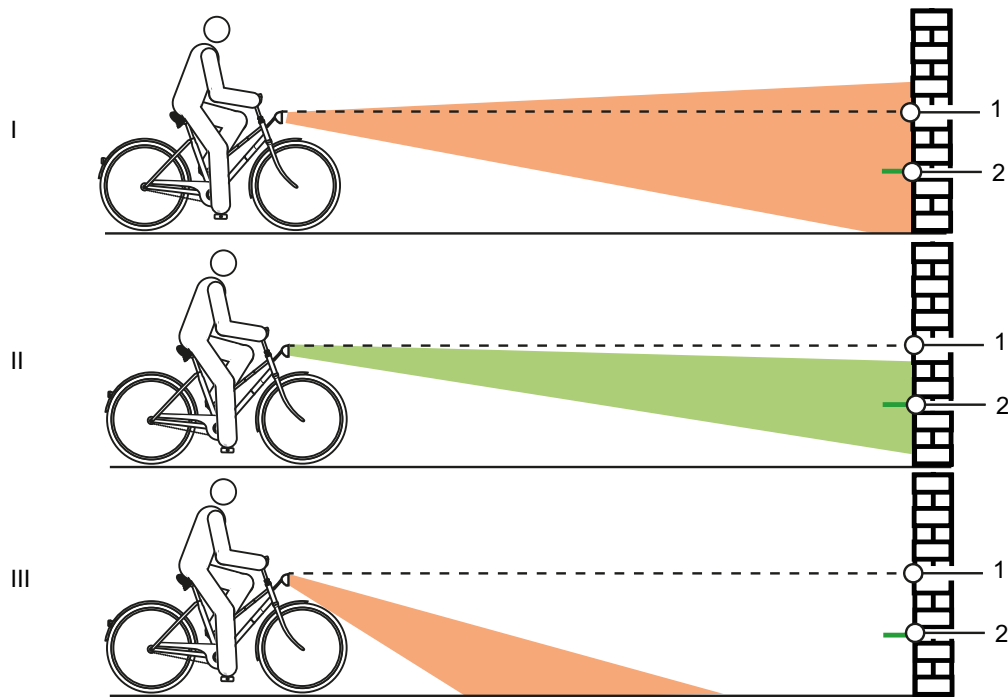

Figure 187: Light positioned too high (1), correctly (2) and too low (3)

- 6 Check the position of the light beam.
- ⇒ If the light is positioned too high or too low, adjust riding light (see Section [6.5.14](#)).

7.5.11 Checking the stem

- ▶ The stem and quick release system must be inspected at regular intervals. The specialist dealer should adjust them if they require adjustment.
- ▶ If the hexagon socket head screw is also loosened, the bearing clearance also needs to be adjusted. Medium-strength thread locker, such as Loctite blue, then needs to be applied to the loosened screws and the screws tightened as per specifications.
- ▶ Check metal contact surfaces on cone, stem clamping screw and fork steerer for corrosion.
- ⇒ Take pedelec out of service if there is any wear or signs of corrosion. Contact specialist dealer.

7.5.12 Checking the handlebars

- 1 Take hold of handlebars with both hands on the handles.
 - 2 Move handlebars up and down and press to tilt.
- ⇒ If the handlebars move, Contact specialist dealer.
- 3 Place front wheel in position where it can't move sideways (e.g. in a bike stand).
 - 4 Hold handlebars firmly with both hands.
 - 5 Check if the handlebars are able to twist against the front wheel.
- ⇒ If the handlebars can move, contact your specialist dealer.

7.5.13 Checking the saddle

- 1 Hold saddle firmly.
 - 2 Check whether the saddle twists, tilts or can be pushed in one direction or other.
- ⇒ If the saddle twists, tilts or can be pushed in one direction or other, adjust the saddle (see Section 6.5.4).
 - ⇒ Contact your specialist dealer if the saddle cannot be fixed into position.

7.5.14 Checking the seat post

- 1 Take seat post out of the frame.
 - 2 Check seat post for cracks and corrosion.
 - 3 Reinsert seat post.
 - 4 Check pedal.
 - 5 Hold pedal and try to move it sideways toward the inside or outside. In doing so, observe whether the crank arm or bearing move sideways.
- ⇒ If the pedal, crank arm or crank bearing moves sideways, fasten screw on the pedal crank rear.
- 6 Hold pedal and try to move it upwards and downwards vertically. In doing so, observe whether the pedal, crank arm or crank bearing moves vertically.
- ⇒ If the pedal, crank arm or crank bearing moves vertically, fasten screw.

7.5.14.1 Checking the derailleur gears

The chain is tensioned by the rear derailleur in pedelecs with derailleur gears.

- 1 Place the pedelec on stand.
 - 2 Check to see if the chain is sagging.
 - 3 Gently press the rear derailleur forwards to check whether it moves and whether it goes back into position by itself.
- ⇒ If the chain is sagging or the rear derailleur does not go back into position by itself, contact your specialist dealer.

7.5.14.2 Checking the hub gear

In the case of pedelecs with a hub gear or back-pedal brake, the chain or the belt is tensioned by an eccentric bearing or movable fork end in the bottom bracket axle. Special tools and specialist knowledge are required to tension the chain.

Contact specialist dealer.

✓ Remove the chain guard on pedelecs with a circumferential chain guard.

- 1 Place the pedelec on stand.
- 2 Check the chain or belt tension in three or four positions, turning the crank a full revolution.

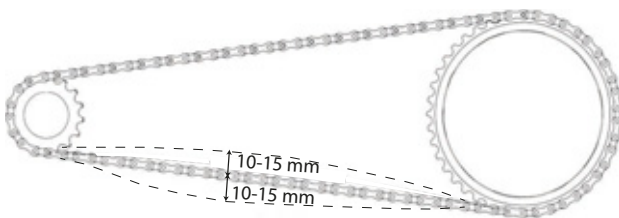

Figure 188: Checking the chain tension

- ⇒ If the chain or the belt can be pushed more than 2 cm, the chain will need to be re-tensioned. Contact specialist dealer.
- ⇒ If the chain or belt can only be pushed up and down less than 1 cm, you will need to the chain or belt slightly. Contact specialist dealer.
- ⇒ The ideal chain and belt tension has been achieved if the chain can be pushed between a maximum of 10 and 15 mm in the middle between the pinion and the toothed wheel. The crank must also turn without resistance.

7.5.15 Check gear shift

- 1 Check that all gear shift components are free of damage.
- 2 Contact your specialist dealer if components are damaged.
- 3 Place the pedelec on stand.
- 4 Turn the pedal crank clockwise.
- 5 Switch through all speeds.
- 6 Check that pedelec can switch through all speeds without making unusual noises.
- 7 Adjust the gear shift if gears cannot be changed correctly.

7.5.15.1 Electric gear shift

- 1 Check the cable connections for damage and corrosion and ensure they are firmly in position.
- ⇒ If cable connections are loose, damaged or corroded, contact your specialist dealer.

7.5.15.2 Mechanical gear shift

- 1 Change gear a number of times. Check whether the Bowden cables get stuck or they make scraping noises.
 - 2 Check the physical condition of the Bowden cables for visible damage and check to see if wire strands are broken.
- ⇒ Have defective Bowden cables replaced. Contact specialist dealer.

7.5.15.3 Checking the derailleur gears

- 1 Check that there is clearance between the chain tensioner and spokes.
 - ⇒ If there is no clearance or the chain scrapes against the spokes or tyres, contact your specialist dealer.
- 2 Check that there is clearance between the chain or rear derailleur and spokes.
 - ⇒ If there is no clearance or the chain scrapes against the spokes, contact your specialist dealer.

7.5.16 Adjusting gear shift

7.5.16.1 Adjusting the ROHLOFF hub

Only applies to pedelecs with this equipment

- 1 Check whether shift cable tension is set in such a way that there is a perceptible play of around 5 mm when the shift handle is turned.
- 2 Adjust the shift cable tension by turning the tension adjuster.
 - ⇒ Unscrew the tension adjuster to increase the shift cable tension.
 - ⇒ Tighten the tension adjuster to decrease the shift cable tension.

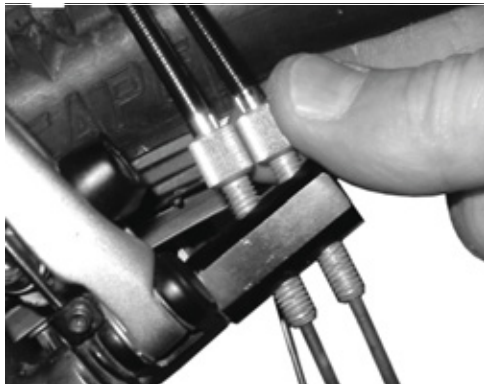

Figure 189: The tension adjuster on ROHLOFF hub versions with internal switch control is located on the tension counter support



Figure 190: The tension adjuster on ROHLOFF hub versions with external switch control is located on the cable box positioned on the left-hand side

- 3 If the marking and numbers on the shift handle to no longer coincide after the gear shift is adjusted, tighten one of the tension adjusters and screw out the other tension adjuster to the same extent.

7.5.17 Adjusting cable-operated gear shift, dual-cable

Only applies to pedelecs with this equipment

- ▶ For a smooth gear shift, set the adjusting sleeves underneath the chain stay on the frame.
- ▶ The shift cable has around 1 mm play when it is pulled out gently.

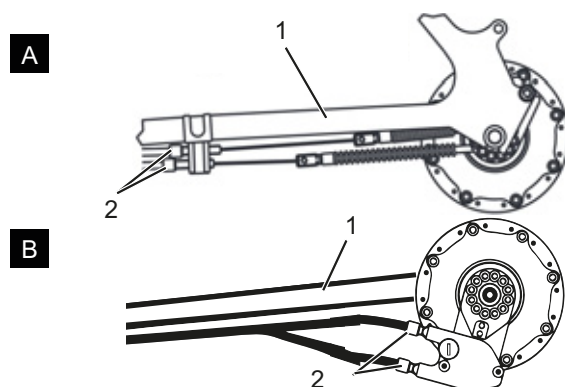

Figure 191: Adjusting sleeves (2) on two alternative versions (A and B) of a dual-cable, Bowden-cable-operated gear shift on the chain stay (1)

7.5.18 Adjusting Bowden-cable-operated twist grip, dual-cable

Only applies to pedelecs with this equipment

- ▶ For a smooth gear shift, set the adjusting sleeves on the shifter housing.
- ⇒ There is noticeable play of 2 to 5 mm (1/2 gear) when you turn the twist grip.

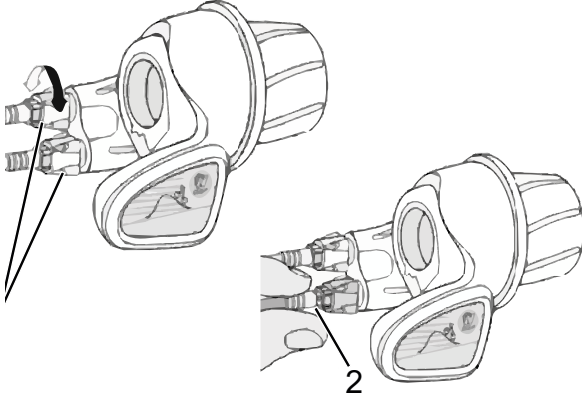

Figure 192: Twist grip with adjusting sleeves (1) and play in the gear shift (2)

7.5.19 Checking kickstand stability

- 1 Place the pedelec on a slight elevation of 5 cm.
 - 2 Extend kickstand.
 - 3 Jolt pedelec to check stability.
- ⇒ If pedelec topples over, tighten screws or change height of the kickstand.

8 Inspection and maintenance

8.1 Initial inspection

After 200 km or 4 weeks after purchase

Vibrations produced while riding can cause screws and springs that were tightened during pedelec manufacture to settle or come loose.

- ▶ Arrange an appointment for the initial inspection directly when purchasing the pedelec.
- ▶ Have the initial inspection entered and stamped in the maintenance book.



- ▶ Carrying out the initial inspection, see Section 8.4.

8.2 Major inspection

every six months

You must have your specialist dealer perform a major inspection every six months as a minimum. This is the only way to ensure that the pedelec remains safe and fully functional.

Tasks require technical expertise, special tools and special lubricants. The pedelec may become damaged if the stipulated major inspection and procedures are not carried out. This is why only specialist dealers may carry out the major inspection.

- ▶ Contact your specialist dealer and arrange an appointment.
- ▶ Enter and stamp major inspection tasks in the maintenance book.



- ▶ Perform major inspection

8.3 Component-specific maintenance

High-quality components require extra maintenance. Tasks require technical expertise, special tools and special lubricants. The pedelec may become damaged if the stipulated maintenance intervals and procedures are not carried out. This is why only specialist dealers may carry out maintenance.

Correct maintenance on the fork not only guarantees a long service life, but also ensures optimal performance.

Each maintenance interval shows the maximum cycling hours for the required type of maintenance that the component manufacturer recommends.

- ▶ Optimise performance with shorter maintenance intervals, depending on use, terrain and environmental conditions.



- ▶ Enter any components with extra maintenance requirements with their corresponding maintenance intervals into the maintenance book when the pedelec is purchased.
- ▶ Inform the buyer of the additional maintenance schedule.
- ▶ Enter and stamp maintenance tasks in the maintenance book.

Inspection and maintenance intervals for suspension fork		
SR SUNTOUR suspension fork		
<input type="checkbox"/>	Maintenance 1	Every 50 hours
<input type="checkbox"/>	Maintenance 2	Every 100 hours
FOX suspension fork		
<input type="checkbox"/>	Maintenance	Every 125 hours or once a year
RockShox suspension fork		
<input type="checkbox"/>	Maintenance of stanchions for: Paragon™, XC™ 28, XC 30, 30™, Judy®, Recon™, Sektor™, 35™*, Bluto™, REBA®, SID®, RS-1™, Revelation™, PIKE®, Lyrik™, Yari™, BoXXer	Every 50 hours
<input type="checkbox"/>	Maintenance of spring and damper unit for: Paragon, XC 28, XC 30,30 (2015 and earlier), Recon (2015 and earlier), Sektor (2015 and earlier), Bluto (2016 and earlier), Revelation (2017 and earlier), REBA (2016 and earlier), SID (2016 and earlier), RS-1 (2017 and earlier), BoXXer (2018 and earlier)	Every 100 hours
<input type="checkbox"/>	Maintenance of spring and damper unit for: 30 (2016+), Judy (2018+), Recon (2016+), Sektor (2016+), 35 (2020+)*, Revelation (2018+), Bluto (2017+), REBA (2017+), SID (2017+), RS-1 (2018+), PIKE (2014+), Lyrik (2016+), Yari (2016+), BoXXer (2019+)	Every 200 hours

Inspection and maintenance intervals for seat post		
by.schulz suspension seat post		
<input type="checkbox"/>	Maintenance	After the first 250 km; every 1,500 km after that
SR SUNTOUR suspension seat post		
<input type="checkbox"/>	Maintenance	Every 100 hours or once a year
eightpins suspension seat post		
<input type="checkbox"/>	Clean wiper	20 hours
<input type="checkbox"/>	Clean slide bushing	40 hours
<input type="checkbox"/>	Replace slide bushing, wiper and felt strip	100 hours
<input type="checkbox"/>	Seal service for gas pressure spring	200 hours
RockShox dropper post		
<input type="checkbox"/>	Venting of remote control lever and/or maintenance of lower seat post unit for: Reverb™ A1/A2/B1, Reverb Stealth A1/A2/B1/C1*	Every 50 hours
<input type="checkbox"/>	Detach lower seat post, clean brass pins, check and replace if necessary and apply new grease for Reverb AXS™ A1*	Every 50 hours
<input type="checkbox"/>	Venting of remote control lever and/or maintenance of lower seat post unit for: Reverb B1, Reverb Stealth B1/C1*, Reverb AXS™ A1*	Every 200 hours
<input type="checkbox"/>	Complete maintenance of seat post for: Reverb A1/A2, Reverb Stealth A1/A2	Every 200 hours
<input type="checkbox"/>	Complete maintenance of seat post for: Reverb B1, Reverb Stealth B1	Every 400 hours
<input type="checkbox"/>	Complete maintenance of seat post for: Reverb AXS™ A1*, Reverb Stealth C1*	Every 600 hours
FOX suspension seat post		
<input type="checkbox"/>	Maintenance	Every 125 hours or once a year
All other suspension seat posts		
<input type="checkbox"/>	Maintenance	Every 100 hours

Inspection and maintenance intervals for rear frame damper		
RockShox rear frame damper		
<input type="checkbox"/>	Service air chamber assembly	Every 50 hours
<input type="checkbox"/>	Service damper and spring	Every 200 hours
FOX rear frame damper		
<input type="checkbox"/>	Maintenance	Every 125 hours or once a year
SR SUNTOUR rear frame damper		
<input type="checkbox"/>	Complete shock absorber service including damper reassembly and air seal replacement	Every 100 hours

Inspection and maintenance intervals for hub		
SHIMANO 11-speed hub		
<input type="checkbox"/>	Internal oil change and maintenance	1,000 km after start of use, then every 2 years or 2,000 km
All other SHIMANO gear hubs		
<input type="checkbox"/>	Lubricate internal components	Once a year or every 2,000 km
ROHLOFF Speedhub 500/14		
<input type="checkbox"/>	Clean cable box and grease cable drum interior	Every 500 km
<input type="checkbox"/>	Oil change	Every 5,000 km or at least once a year
Pinion		
<input type="checkbox"/>	Maintenance 1 Check drive elements and replace if necessary Clean cable pulley, slide surfaces and gear box interior, epicyclic wheels, etc. thoroughly and grease generously	Every 500 km
<input type="checkbox"/>	Maintenance 2 Replace chain rings and change oil	Every 10,000 km

 **WARNING**
Injury due to damaged brakes

Special tools and specialist knowledge are required to repair the brakes. Incorrect or unauthorised assembly can damage the brakes. This may lead to an accident with serious injuries.

- ▶ Only specialist dealers may carry out repairs on brakes.
- ▶ Only carry out work or changes, such as dismantling, sanding or painting, which are permitted and described in the brake operating instructions.

Injury to the eyes

Problems may arise if the settings are not made properly and you may sustain serious injuries as a result.

- ▶ Always wear safety glasses during Inspection and maintenance work.

 **CAUTION**
Crash and falling caused by unintentional activation

There is a risk of injury if the electric drive system is activated unintentionally.

- ▶ Remove the battery before inspection or maintenance.

Crash caused by material fatigue

If the service life of a component has expired, the component may suddenly fail. This may cause a crash with injuries.

- ▶ Have the specialist dealer carry out basic cleaning of the pedelec every six months, preferably at the same time as the required servicing work.

 **CAUTION**
Hazard for the environment due to toxic substances

The brake system contains toxic and environmentally harmful oils and lubricants. Such fluids will contaminate if they enter the sewers or groundwater.

- ▶ Dispose of lubricants and oils left over after repairs in an environmentally responsible way in accordance with statutory regulations.

Notice

The motor is maintenance-free and only qualified specialist personnel may open it.

- ▶ Never open the motor.

8.4 Carry out initial inspection

Incorrectly fastened screws may come loose due to impact. The stem may no longer be firmly fixed in its position as a result. This will cause a crash with injuries.

- ▶ Check the handlebars and the stem quick release system are firmly in position after the first two hours of riding.

Vibrations produced while riding can cause screws and springs that were tightened during manufacture of the pedelec to settle or come loose.

- 1 Check quick release system is fixed in position.
- 2 Check all tightening torques of screws and screw connections.



8.5 Inspection and maintenance instructions

Complying with these inspection and maintenance instructions is the only way to reduce wear on components, increase the operating hours and guarantee safety.

Diagnosis and documentation of current status

Components	Frequency	Description			Criteria		Measures if rejected
		Inspection	Tests	Inspection/maintenance	Acceptance	Rejection	
Chassis							
Frame	Once a month	Dirt	...	Section 7.3.4	O.K.	Dirt	Cleaning
	6 months	Servicing	...	Section 7.4.1	O.K.	Untreated	Wax
	6 months	Check for damage – fracture, scratches	Section 8.6.1	...	O.K.	Damage detected	Take pedelec out of service, new frame as specified in parts list
Carbon frame (optional)	Once a month	Dirt	Section 7.3.4	...	O.K.	Dirt	Cleaning
	6 months	Servicing	...	Section 7.4.1	O.K.	No wax	Wax
	6 months	Damage to paintwork	Section 8.6.1.1	...	O.K.	Damage to paintwork	Apply paint
	6 months	Damage from impact	Section 8.6.1.1	...	O.K.	Damage from impact	Take pedelec out of service, new frame as specified in parts list
ROCKSHOX Rear frame damper (optional)	6 months	Check for damage, corrosion, fracture	See ROCKSHOX component maintenance instructions	Maintenance as specified by manufacturer Air chamber assembly group, damper and spring.	O.K.	Damage detected	New rear frame damper as specified in parts list
FOX Rear frame damper (optional)	6 months	Check for damage, corrosion, fracture	...	Send to FOX	O.K.	Damage detected	New rear frame damper as specified in parts list
SR SUNTOUR Rear frame damper (optional)	6 months	Check for damage, corrosion, fracture	See SR SUNTOUR component maintenance instructions	Maintenance as specified by manufacturer Complete shock absorber service including damper reassembly and air	O.K.	Damage detected	New rear frame damper as specified in parts list
Steering system							
Handlebars	Once a month	Cleaning	...	Section 7.3.6	O.K.	Dirt	Cleaning
	6 months	Wax	...	Section 7.4.7	O.K.	Untreated	Wax
	6 months	Check mount fastening	Section 7.5.12	...	O.K.	Loose, rust	Retighten screws; new handlebars as specified in parts list if necessary
Stem	Once a month	Cleaning	...	Section 7.3.5	O.K.	Dirt	Cleaning
	6 months	Wax	...	Section 7.4.6	O.K.	Untreated	Wax
	6 months	Check mount fastening	Section 7.5.11 and Section 8.6.4	...	O.K.	Loose, rust	Retighten screws; new stem as specified in parts list if necessary



Components	Frequency	Description			Criteria		Measures if rejected
		Inspection	Tests	Maintenance	Acceptance	Rejection	
Handles	Once a month	Cleaning	...	Section 7.3.7	O.K.	Dirt	Cleaning
	Once a month	Care	Section 7.4.8	...	O.K.	Untreated	Talcum powder
	before each ride	Wear; check if fastened securely	Section 7.1.11	...	O.K.	Missing, wobbles	Retighten screws, new handles and coverings as specified in parts list
Steering headset	6 months	Clean and check for damage	...	Clean, lubricate and adjust	O.K.	Unclean	Clean and lubricate
Fork (rigid)	6 months	Check for damage, corrosion, fracture	...	Dismount, check, lubricate, refit	O.K.	Damage detected	New fork as specified in the parts list
Carbon fork (optional)	6 months	Check for damage, corrosion, fracture	...	Maintenance as specified by manufacturer Lubrication, oil change as specified by manufacturer	O.K.	Damage detected	New fork as specified in the parts list
SR SUNTOUR suspension fork (optional)	6 months	Check for damage, corrosion, fracture	...	Maintenance as specified by manufacturer Lubrication, oil change as specified by manufacturer	O.K.	Damage detected	New fork as specified in the parts list
FOX suspension fork (optional)	6 months	Check for damage, corrosion, fracture	...	Send to FOX	O.K.	Damage detected	New rear frame damper as specified in parts list
RockShox suspension fork (optional)	6 months	Check for damage, corrosion, fracture	...	Maintenance as specified by manufacturer Lubrication, oil change as specified by manufacturer	O.K.	Damage detected	New fork as specified in the parts list
Spinner suspension fork (optional)	6 months	Check for damage, corrosion, fracture	...	Maintenance as specified by manufacturer Lubrication, oil change as specified by manufacturer	O.K.	Damage detected	New fork as specified in the parts list
Wheel							
Wheel	before each ride	Concentricity	Section 7.1.7	...	O.K.	Not straight	Re-mount wheel
	6 months	Assembly	Section 7.5.1	...	O.K.	Loose	Adjust quick release
Tyres	Once a month	Cleaning	Section 7.3.10	...	O.K.	Dirt	Cleaning
	once a week	Tyre pressure	Section 7.5.1.1	...	O.K.	Tyre pressure too low/ too high	Adjust tyre pressure
	10 days	Wear	Section 7.3.10	...	O.K.	Worn profile	New tyre as specified in the parts list



Components	Frequency	Description			Criteria		Measures if rejected
		Inspection	Tests	Maintenance	Acceptance	Rejection	
Rims	6 months	Wax	...	Section 7.4.10	O.K.	Untreated	Wax
	6 months	Wear	Section 7.5.1.3	...	O.K.	Defective rim	New rim as specified in the parts list
	Once a month	Wear on brake surface	Section 7.5.2.6	...	O.K.	Worn brake surface	New rim as specified in the parts list
Spokes	Once a month	Cleaning	...	Section 7.3.11	O.K.	Dirt	Cleaning
	3 months	Check tension	Section 7.5.1.3	...	O.K.	Loose, tension varies	Re-tension spokes or new spokes as specified in parts list
	6 months	Check rim hooks	Section 7.5.1.3	...	O.K.	Twisted rim hooks	New rim as specified in the parts list
Spoke nipples	Once a month	Cleaning	...	Section 7.3.11	O.K.	Dirt	Cleaning
	Once a month	Wax	...	Section 7.4.13	O.K.	Untreated	Wax
Nipple holes	6 months	Check for cracks	Section 7.5.1.4	...	O.K.	Cracks	New rim as specified in the parts list
Nipple well	Once a year	Check for cracks	Section 7.5.1.5	...	O.K.	Cracks	New rim as specified in the parts list
Hub	Once a month	Cleaning	...	Section 7.3.12	O.K.	Dirt	Cleaning
	Once a month	Care	...	Section 7.4.12	O.K.	Untreated	Treat
Hub with cone bearing (optional)	Once a month	Cleaning	...	Section 7.3.12	O.K.	Dirt	Cleaning
	Once a month	Care	...	Section 7.4.12	O.K.	Untreated	Treat
	6 months	Check mount fastening	O.K.	Loose, rust	Retighten screws; new handlebars as specified in parts list if necessary
	Once a year	Adjust	O.K.	Not adjusted	New position
Hub gear (optional)	Once a month	Cleaning	...	Section 7.3.12	O.K.	Dirt	Cleaning
	Once a month	Care	...	Section 7.4.12	O.K.	Untreated	Treat
	6 months	Check mount fastening	O.K.	Loose, rust	Retighten screws; new handlebars as specified in parts list if necessary
	6 months	Functional check	Section 7.5.14.2	incorrect switching	Readjust hub
Saddle and seat post							
Saddle	Once a month	Cleaning	...	Section 7.3.9	O.K.	Dirt	Cleaning
	6 months	Check mount fastening	Section 7.5.13	...	O.K.	Loose	Retighten screws
Leather saddle (optional)	Once a month	Cleaning	...	Section 7.3.9.1	O.K.	Dirt	Cleaning
	6 months	Care	...	Section 7.4.11	O.K.	Untreated	Leather wax
	6 months	Check mount fastening	Section 7.5.13	...	O.K.	Loose	Retighten screws
Seat post	Once a month	Cleaning	...	Section 7.3.8	O.K.	Dirt	Cleaning
	6 months	Care	O.K.	Untreated	Leather wax
	6 months	Complete clean, check fastening and paint protection film	...	Section 8.6.8	O.K.	Loose	Tighten screws, new paint protection film



Components	Frequency	Description			Criteria		Measures if rejected
		Inspection	Tests	Maintenance	Acceptance	Rejection	
Carbon seat post (optional)	Once a month	Cleaning	...	Section 7.3.8	O.K.	Dirt	Cleaning
	6 months	Care	...	Section 7.4.9.2	O.K.	Untreated	Assembly paste
	6 months	Complete clean, check fastening and paint protection film	...	Section 8.6.8.1	O.K.	Loose	Tighten screws, new paint protection film; new seat post as specified in parts list if damaged
Suspension seat post (optional)	Once a month	Cleaning	O.K.	Dirt	Cleaning
	6 months	Care	...	Section 7.4.9.1	O.K.	Untreated	Oils
	100 hours or 6 months	Complete clean, check fastening and paint protection film	Section 8.6.8	...	O.K.	Loose	Tighten screws, new paint protection film
by.schulz suspension seat post (optional)	After the first 250 km; every 1500 km after that	Complete clean, check fastening and paint protection film, lubricate	Section 8.6.8.2	...	O.K.	Loose	Tighten screws, new paint protection film; new seat post as specified in parts list if damaged
SR SUNTOUR suspension seat post	Every 100 hours or Once a year	Complete clean, check fastening and paint protection film, lubricate	Section 8.6.8.3	...	O.K.	Loose	Tighten screws, new paint protection film; new seat post as specified in parts list if damaged
eightpins NGS2 Suspension seat post	20 Hours	Refill oil	...	Section 7.4.19	O.K.	No oil	Refill oil
	20 Hours	Clean wiper	...		O.K.	Dirt	Cleaning
	40 Hours	Clean slide bushing	...		O.K.	Dirt	Cleaning
	100 Hours	Replace slide bushing, wiper and felt strip	...		O.K.	No replacement	Replace
	200 Hours	Seal service for gas pressure spring	...		O.K.	No service	Carry out the service
eightpins H01 Suspension seat post	20 Hours	Refill oil	...	Section 7.4.19	O.K.	No oil	Refill oil
	20 Hours	Clean wiper	...		O.K.	Dirt	Cleaning
	40 Hours	Clean slide bushing	...		O.K.	Dirt	Cleaning
	100 Hours	Replace slide bushing, wiper and felt strip	...		O.K.	No replacement	Replace
	200 Hours	Seal service for gas pressure spring	...		O.K.	No service	Carry out the service



Components	Frequency	Description			Criteria		Measures if rejected
		Inspection	Tests	Maintenance	Acceptance	Rejection	
RockShox dropper post	50 Hours	Venting	...	See manufacturer	O.K.		
	50 Hours	Cleaning	...	See manufacturer	O.K.		
	200 Hours	Venting	...	See manufacturer	O.K.		
	200 Hours	Complete maintenance	...	See manufacturer	O.K.		
	400 Hours	Complete maintenance	...	See manufacturer	O.K.		
	600 Hours	Complete maintenance	...	See manufacturer	O.K.		
FOX suspension seat post	125 hours or Once a year	Complete maintenance	See manufacturer	At the manufacturer FOX	
Safety guards							
Belt or chain guards	6 months	Attachment	Check mount fastening	...	O.K.	Loose	Retighten screws
Guard	6 months	Attachment	Check mount fastening	...	O.K.	Loose	Retighten screws
Motor cover	6 months	Attachment	Check mount fastening	...	O.K.	Loose	Retighten screws
Brake system							
Handbrake	6 months	Attachment	Check mount fastening	...	O.K.	Loose	Retighten screws
Brake fluid	6 months	Check fluid level	Depending on time of year	...	O.K.	Too little	Top up brake fluid; <i>take Pedelec out of service</i> if damaged; new brake hoses
Brake linings	6 months	Brake linings, brake discs and rims	Check for damage	...	O.K.	Damage detected	New brake linings, brake discs and rims
Back-pedal brake braking armature	6 months	Attachment	Check mount fastening	...	O.K.	Loose	Retighten screws
Brake system	6 months	Attachment	Check mount fastening	...	O.K.	Loose	Retighten screws
Lighting system							
Light cabling	6 months	Connections, correct wiring	Check	...	O.K.	Cable defective, no light	New cabling
Rear light	6 months	Side light	Functional check	...	O.K.	No constant light	New rear light as specified in parts list; replace if necessary
Front light	6 months	Side light, daytime riding light	Functional check	...	O.K.	No constant light	New front light as specified in parts list; replace if necessary
Reflectors	6 months	All complete, state, fastening	Check	...	O.K.	Damaged or not all complete	New reflectors



Components	Frequency	Description			Criteria		Measures if rejected
		Inspection	Tests	Maintenance	Acceptance	Rejection	
Drive/gear shift							
Chain/cassette/pinion/chainring	6 months	Check for damage	Check for damage	...	O.K.	Damage	Refasten if necessary or replace as specified in parts list
Chain guard/spoke guard	6 months	Check for damage	Check for damage	...	O.K.	Damage	Replace as specified in parts list
Bottom bracket axle/crank	6 months	Check mount fastening	Check mount fastening	...	O.K.	Loose	Retighten screws
Pedals	6 months	Check mount fastening	Check mount fastening	...	O.K.	Loose	Retighten screws
Shifter	6 months	Check mount fastening	Check mount fastening	...	O.K.	Loose	Retighten screws
Shift cables	6 months	Check for damage	Check for damage	...	O.K.	Loose and defective	Adjust shift cables; new shift cables if necessary
Front derailleur	6 months	Check for damage	Check for damage	...	O.K.	Gear shift difficult or not possible	Adjust
Rear derailleur	6 months	Check for damage	Check for damage	...	O.K.	Gear shift difficult or not possible	Adjust
Electric drive system							
On-board computer	6 months	Check for damage	Check for damage	...	O.K.	No screen, defective screen display	Restart, test battery, new software or new on-board computer, <i>decommissioning</i> ,
Control panel	6 months	Check control panel for damage	Check for damage	...	O.K.	No response	Restart; contact control panel manufacturer, new control panel
Tachometer	6 months	Calibration	Speed measurement	...	O.K.	Pedelec travelling 10% too fast/slow	Take pedelec out of service until the source of the error is found
Cabling	6 months	Visual inspection	Visual inspection	...	O.K.	Failure in system, damage, kinked cables	New cabling
Rechargeable battery	6 months	First examination	See Section on Assembly	...	O.K.	Error message	Contact battery manufacturer; <i>take out of service</i> , new battery
Battery mount	6 months	Firmly in position, lock, contacts	Check mount fastening	...	O.K.	Loose; lock doesn't close, no contacts	New battery mount
Motor	6 months	Visual inspection and mount	Check mount fastening	...	O.K.	Damage, loose	Refasten motor, contact motor manufacturer, new motor; <i>take out of service</i>
Software	6 months	Check version	Check software version	...	In latest version	Not latest version	Import update



Components	Frequency	Description			Criteria		Measures if rejected
		Inspection	Tests	Maintenance	Acceptance	Rejection	
Miscellaneous							
Pannier rack	before each ride	Stability	Section 7.1.5	...	O.K.	Loose	Firm
	Once a month	Dirt	...	Section 7.3.4	O.K.	Dirt	Cleaning
	6 months	Servicing	...	Section 7.4.3	O.K.	Untreated	Wax
	6 months	Check fastening and paint protection film	Section 8.5.2	...	O.K.	Loose	Tighten screws, new paint protection film
Kickstand	Once a month	Dirt	...	Section 7.3.4	O.K.	Dirt	Cleaning
	6 months	Servicing	...	Section 7.4.5	O.K.	Untreated	Wax
	6 months	Attachment	Section 7.5.19	...	O.K.	Loose	Retighten screws
	6 months	Stability	Section 7.5.19	...	O.K.	Tips over	Change kickstand height
Bell	before each ride	Sound	Functional check, Section 7.1.10.	...	O.K.	No ring, too quiet, missing	New bell as specified in the parts list
Attachments (optional)	6 months	Attachment	Check mount fastening	...	O.K.	Loose	Retighten screws

Technical inspection, checking safety, test ride

Components	Description		Criteria		Measures if rejected
	Assembly/inspection	Tests	Acceptance	Rejection	
Brake system	6 months	Functional check	O.K.	No full braking; braking distance too long	Locate defective part in brake system and correct
Gear shift under operating load	6 months	Functional check	O.K.	Problems when shifting gear	Readjust gear shift
Suspension components (fork, shock absorber, seat post)	6 months	Functional check	O.K.	Suspension too deep or no longer exists	Locate defective component and correct
Electric drive system	6 months	Functional check	O.K.	Loose connection, problems when riding, accelerate	Locate faulty component in electric drive system and remedy
Lighting system	6 months	Functional check	O.K.	No continuous light, not bright enough	Locate defective part in lighting system and correct
Test ride	6 months	Functional check	No strange noises	Strange noises	Locate source of noise and correct



8.5.1 Inspecting the frame

- 1 Check frame for cracks, warping and damage to the paintwork.
- ⇒ If there are any cracks, warping or damage to the paintwork, remove the pedelec from service. New frame as specified in the parts list.

8.5.1.1 Inspect the carbon frame

You need to distinguish between scratches on the paintwork and impacts if the carbon frame paintwork is damaged.

- ▶ Ask customer what caused the damage.
- ▶ Examine damage with a magnifying glass to see if fibres are permanently damaged or delamination has taken place.

8.5.2 Inspecting the pannier rack

Scratches, cracks and breaks may appear on the pannier rack caused by the panniers and cargo boxes.

- 1 Examine pannier rack for scratches, cracks and breaks.
- ⇒ Replace damaged pannier racks.
- ⇒ If the paint protection film is missing or has worn away, affix a new paint protection film.

8.5.3 Inspect and maintain rear frame damper

Only applies to pedelecs with this equipment



WARNING

Injury due to explosion

The air chamber is pressurised. If the air system is serviced in a rear frame damper, it can explode and cause serious injury.

- ▶ Wear safety goggles, protective gloves and safety clothing when assembling or carrying out maintenance on the bicycle.
- ▶ Release the air for the air chambers. Detach all air insert fitments.
- ▶ Never service or dismantle a rear frame damper if it has not completely rebounded.

Intoxication from suspension oil

Suspension oil is poisonous to the touch, irritates respiratory tracts and causes cancer, sterility and mutation in germ cells.

- ▶ Always wear safety goggles and nitrile gloves when carrying suspension oil.
- ▶ Never perform inspection or maintenance when you are pregnant.
- ▶ Use an oil catchment tray under the section where the rear frame damper is being serviced.

Intoxication from lubrication oil

The lubrication oil for Eightpins seat posts is toxic if touched or inhaled.

- ▶ Always wear safety goggles and nitrile gloves when working with lubrication oil.
- ▶ Lubricate seat post in the open air or in a well-ventilated room only.
- ▶ Avoid skin coming into contact with lubrication oil. Wear nitrile gloves when lubricating, cleaning and servicing the vehicle.
- ▶ Use an oil catchment tray under the section where the seat post is serviced.

 **CAUTION**
Hazard for the environment due to toxic substances

The rear frame damper contains toxic and environmentally harmful oils and lubricants. Such fluids will contaminate if they enter the sewers or groundwater.

- ▶ Dispose of lubricants and oils left over after repairs in an environmentally responsible way in accordance with statutory regulations.

- 1 Dismantle the rear frame damper.
 - 2 Clean and inspect its interior and exterior.
 - 3 Recondition air springs.
 - 4 Replace airtight seals on air springs.
 - 5 Change oil.
- ⇒ Replace dust wipers.

8.5.4 Inspect gear hub

8.5.4.1 Adjusting the hub with cone bearing

In the case of hubs with a cone bearing, the bearing shell fixed in the hub cone body rotates with its larger ball bearing surfaces around the inner bearing cone resting against the fork end. The outer bearing shell rotating around the stationary bearing cone is subject to considerably more evenly distributed loads thanks to its larger ball running surface.

- 1 Attach a small, red colour marking on the lock nut.
 - 2 Turn the wheel axle 40° to 90° every 1,000 to 2,000 km.
- ⇒ The bearing cone is subject to evenly distributed loads.

8.5.5 Inspecting the stem

Incorrectly fastened screws may come loose due to impact. The stem may no longer be firmly fixed in its position as a result. This will cause a crash with injuries.

- ▶ Check the handlebars and the stem's quick release are firmly in position.

8.5.6 Inspect and grease steering headset

- 1 Remove fork.
- 2 Clean steering headset. If it is very dirty, flush the bearing with cleaning agents such as WD-40 or Karamba.
- 3 Check steering headset for damage.
 - ⇒ If the steering headset is damaged, replace steering headset as specified in the parts list.
- 4 Grease steering headset and bearing seat with highly viscous, water-repellent grease (e.g. Dura Ace special grease by SHIMANO).
- 5 Re-fit fork with steering headset as per fork instructions.



8.5.7 Inspecting axle with quick release

CAUTION

Crash caused by unfastened quick release

A faulty or incorrectly installed quick release may become caught in the brake disc and block the wheel. This will cause a crash.

- ▶ Install the front wheel quick release lever on the opposite side to the brake disc.

Crash caused by faulty or incorrectly installed quick release

The brake disc becomes very hot during operation. Parts of the quick release may become damaged as a result. The quick release comes loose. This will cause a crash with injuries.

- ▶ The front wheel quick release lever and the brake disc must be situated on opposite sides.

Crash caused by incorrectly set clamping force

Excessively high clamping force will damage the quick release and cause it to lose its function.

Insufficient clamping force will cause a detrimental transmission of force. The suspension fork or the frame may break. This will cause a crash with serious injuries.

- ▶ Never fasten a quick release using a tool (e.g. hammer or pliers).
- ▶ Only use the clamping lever with the specified set clamping force.

- 1 Undo quick release.
- 2 Fasten quick release.
- 3 Check the position and clamping force of the quick release lever.

- ⇒ The quick release lever is flush with the lower housing.
- ⇒ You should be able to see slight impression on the palm of your hand when you close the quick release lever.



Figure 193: Adjusting the quick release clamping force

- 4 Use a 4 mm hexagon socket spanner to adjust the clamping lever clamping force if required.
- 5 Check the quick release lever position and clamping force again.

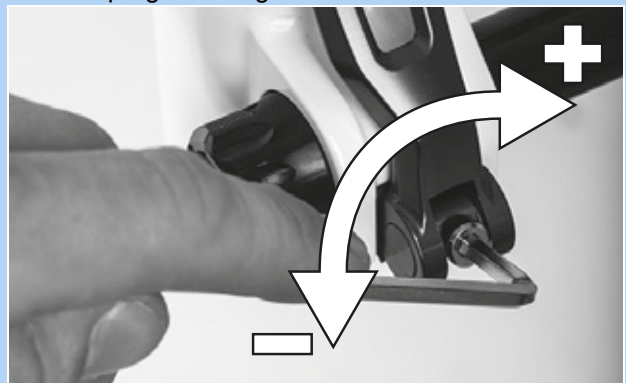

Figure 194: Adjusting the quick release clamping force



8.5.8 Inspecting the fork

WARNING

Injury due to explosion

The air chamber is pressurised. When the air system in a faulty suspension fork is maintained, it may explode and cause serious injury.

- ▶ Wear safety goggles, protective gloves and safety clothing when assembling or carrying out maintenance on the bicycle.
- ▶ Release the air for the air chambers. Detach all air insert fitments.
- ▶ Never service or dismantle a suspension fork if it has not completely rebounded.

CAUTION

Hazard for the environment due to toxic substances

The suspension fork contains toxic and environmentally harmful oils and lubricants. Such fluids will contaminate if they enter the sewers or groundwater.

- ▶ Dispose of lubricants and oils left over after repairs in an environmentally responsible way in accordance with statutory regulations.

- 1 Remove fork.
- 2 Check fork for cracks, warping and damage to the paintwork.
 - ⇒ If there are any cracks, warping or damage to the paintwork, remove the pedelec from service. New fork as specified in the parts list.
- 3 Clean inside and exterior.
- 4 Grease fork.
- 5 Install fork.

8.5.8.1 Inspect the carbon suspension fork

Only applies to pedelecs with this equipment

- 1 Remove fork.
- 2 Check fork for cracks, warping and damage to the paintwork.
- 3 You need to distinguish between scratches on the paintwork and impacts if the carbon suspension fork paintwork is damaged.
 - ▶ Ask customer what caused the damage.
 - ▶ Examine damage with a magnifying glass to see if fibres are permanently damaged or delamination has taken place.

8.5.8.2 Inspect the suspension fork

Only applies to pedelecs with this equipment

- 1 Remove fork.
- 2 Check fork for cracks, warping and damage to the paintwork.
 - ⇒ If there are any cracks, warping or damage to the paintwork, remove the pedelec from service. New fork as specified in the parts list.
- 3 Dismantle suspension fork.
- 4 Lubricate dust seals and slide bushings.
- 5 Check torques.
- 6 Clean inside and exterior.
- 7 Grease fork.
- 8 Install fork.
- 9 Adjust suspension fork (see Section 6.3.14).



8.5.9 Inspecting the seat post



WARNING

Intoxication from lubrication oil

The lubrication oil for Eightpins seat posts is toxic if touched or inhaled.

- ▶ Always wear safety goggles and nitrile gloves when working with lubrication oil.
- ▶ Lubricate seat post in the open air or in a well-ventilated room only.
- ▶ Avoid skin coming into contact with lubrication oil. Wear nitrile gloves when lubricating, cleaning and servicing the vehicle.
- ▶ Use an oil catchment tray under the section where the seat post is serviced.

- 1 Remove seat post from the frame.
 - 2 Clean seat post on the inside and outside.
 - 3 Examine seat post rack for scratches, cracks and breaks.
- ⇒ Replaced damaged seat post as specified in the parts list.
- 4 Fit seat post as per height specifications in the pedelec pass.

8.5.9.1 Inspect carbon seat post

Only applies to pedelecs with this equipment

You need to distinguish between scratches on the paintwork and impacts if the carbon seat post paintwork is damaged.

- ▶ Ask customer what caused the damage.
- ▶ Examine damage with a magnifying glass to see if fibres are permanently damaged or delamination has taken place.



8.5.9.2 Inspecting and greasing BY.SCHULZ suspension seat post

Only applies to pedelecs with this equipment

- 1 Remove seat post from the frame.
 - 2 Remove safety and protective cover.
 - 3 Clean seat post on the inside and outside.
 - 4 Examine seat post rack for scratches, cracks and breaks.
- ⇒ Replaced damaged seat post as specified in the parts list.
- 5 Lubricate screws in the parallel suspension.
 - 6 Reinsert seat post as per height specifications in the pedelec pass. Check screws for correct tightening torques.

□	Torques G1 M8 seat clamp screw M5 fixing grub screws	20 ... 24 Nm 3 Nm
---	---	----------------------

□	Torque G2 M6 seat clamp screw M5 fixing grub screws	12 ... 14 Nm 3 Nm
---	--	----------------------

- 7 Put on safety and protective cover.

8.5.9.3 Inspecting and greasing RS SUNTOUR suspension seat post

Only applies to pedelecs with this equipment

- 1 Remove seat post from the frame.
 - 2 Remove safety and protective cover.
 - 3 Examine seat post rack for scratches, cracks and breaks.
- ⇒ Replaced damaged seat post as specified in the parts list.
- ⇒ If the paint protection film protecting a child seat is missing or has worn away, affix a new paint protection film.
- 4 Undo pre-tensioning adjuster and take out steel spring.
 - 5 Clean seat post on inside and outside.
 - 6 Grease seat post on inside with SR SUNTOUR grease no. 9170-001.
 - 7 Lubricate pressure roller with bicycle chain oil.
- ▶ Lubricate articulated joints in parallel suspension with bike chain oil.

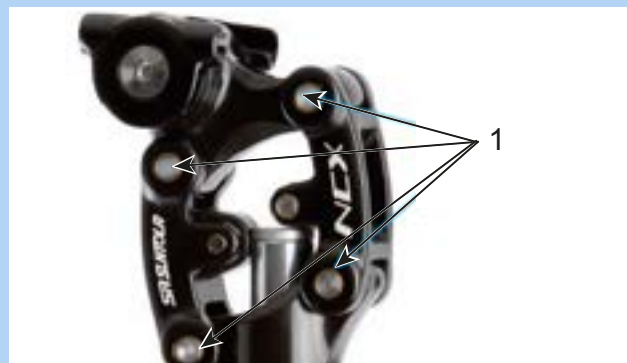

Figure 195: SR SUNTOUR suspension seat post lubrication points

- 8 Reinsert seat post as per height specifications in the pedelec pass.
- 9 Check screws for correct tightening torques.

□	SR SUNTOUR suspension seat post torques Seat clamp screw M5 fixing grub screws	15–18 Nm 3 Nm
---	---	------------------

- 10 Put on safety and protective cover.



8.5.9.4 FOX component-specific maintenance

FOX Service must perform maintenance on suspension forks, rear frame damper and suspension seat posts.

- ▶ Maintenance includes a complete inspection of interiors and exteriors.
- ▶ All dampers are reconditioned.
- ▶ The airtight seals are replaced in air suspension forks.
- ▶ The air spring is reconditioned.
- ▶ The oil is changed.
- ▶ The dust wipers are replaced.

More information at:

www.foxracingshox.de/service

9 Troubleshooting, fault clearance and repair

9.1 Preventing pain

A pedelec is a sports vehicle which promotes health.

After the first few rides, you may experience sore muscles the next day. However, permanent pain should never occur during or after a ride.

Medical problems may be the cause of pain. Any such problems should thus always be discussed openly with a doctor.

In most cases, however, pain after pedelec rides is due to a lack of training and components set incorrectly or components that are not adjusted to the rider's physique.

The most common complaints are:

- 1 Sitting discomfort
- 2 Pain in hips
- 3 Backache
- 4 Pain in shoulders and nape of neck
- 5 Numb or aching hands
- 6 Pain in upper thigh
- 7 Pain in the knee
- 8 Pain in the foot

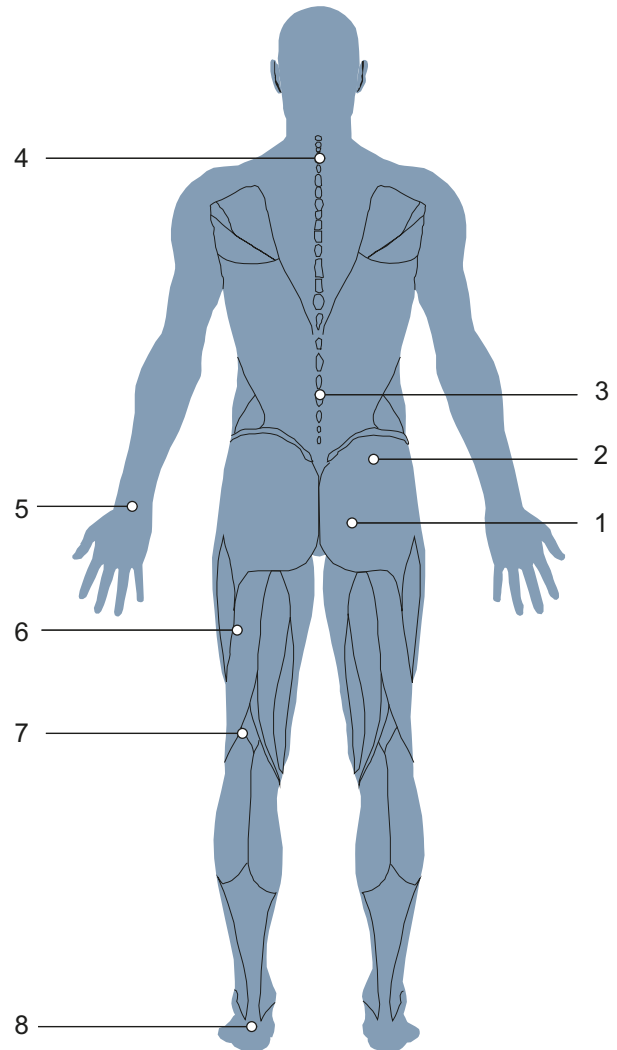

Figure 196: Known pain due to lack of training and/or incorrect component adjustment

9.1.1 Sitting discomfort

Around 50% of all pedelec riders experience sitting discomfort:

- Pressure pain in the sitting bones
- Pain in the lower back
- Pressure pain and numbness in perineal region

Solution

- Adopt an optimal riding position (see Section 6.5.3).
- Adjust the saddle height and tilt (see Section 6.5.4).
- Wear cycling shorts and use chamois cream (see Section 6.12).
- Use an ergonomically adjusted saddle (see Section 6.5.4).



- Ride standing up now and again.

9.1.2 Pain in hips

Lower back pain is often not caused by the back muscles, but by the iliopsoas muscle instead. This muscle is part of the inner hip musculature and flexes the hip. It is attached to the thigh bone and reaches up to the spine. Pain can occur in the back if this muscle is strained too much or shortened.

Solution



- Strengthening exercises for the iliopsoas muscle
- Stretching exercises for hip flexors and extensors.

9.1.3 Backache

Riding a pedelec strengthens the back musculature. The greater the saddle-to-bar drop is, the greater the strain on the back musculature is. At the beginning, a posture where you lean too far forward can lead to pain in the back, arms and wrists. The abdominal muscles are the counterpart to the back muscles and stabilise the pelvis and the back. Back pain is thus often caused by weak abdominal muscles.

Solution



- Contact specialist dealer. You need to adopt a more upright sitting position (see Section 6.5.3).
- Stretching exercises for the back and abdominal muscle ligaments and moderate bicycle training will lengthen the tendons and build new back and abdominal muscles.

The desired position can be adopted after a period of training.

9.1.4 Pain in shoulders and nape of neck

The weight of the upper body places a strain on the shoulders due to the bent-forward posture. The more stretched the position is, the more strain there is on the shoulders.

The specific posture adopted is often the source of pain. Pedelec riders often extend their arms. Impacts such as those occurring on bumpy roads are thus transmitted to the shoulders without suspension. This causes severe pain.

Another source of pain is a hunchback. Due to the posture adopted, the neck needs to be extended backwards excessively so that the rider can look forwards. This causes strain in the neck and shoulder muscles.

9.1.5 Numb or aching hands

Your hands are one of the three points of contact when you ride a pedelec. The hands transmit the weight of the upper body to the handlebars. In the upright Holland position, there is almost no weight applied whereas body weight is at its highest in the sports position. The force is applied to a small area on the handle, meaning the pressure load on the hands is very high. Hands are highly sensitive and can bear a maximum of 20% of body weight during prolonged exposure to load.

9.1.6 Pain in upper thigh

Pain in the upper thigh is usually due to muscular problems. A muscular imbalance between the extensors, flexors and adductors can cause this pain.

Solution



- A more upright riding position will immediately reduce pain.
- Always bend elbows slightly.
- ⇒ The elbow joint will not block. The arms cushion impacts.
- Adjust the handlebars (see Section 6.5.5)
- Always adopt an optimal riding position (see Section 6.5.3).

Solution

- Position handles perfectly (see Section 6.5.5.1, 6.5.5.2 and 6.5.8)
- Move hands and arms while riding (see Section 6.15)
- Use padded cycling gloves (see Section 2.15)
- Optimise handles (see Section 6.5.7).

Solution

- Increasing assistance on the pedelec will bring immediate relief.



- Targeted exercises to correct imbalance and shortening of the thigh muscles.
- Stretching exercises for the thigh muscles.

9.1.7 Knee pain

Pedelec riding is a sport that is easy on the knee joints and is recommended for beginners. Very powerful forces are transmitted from the thigh to the foot via the knee when pedalling. As a result, the tendons and cartilage in the knee are subjected to great stress.

Pain on the inside and outside of the knee is often caused by incorrect adjustment of the click system and the foot being out of position as a consequence. Pain in the lower part of the knee usually stems from an improper riding position

Cold weather can also cause knee pain. Tendons are less elastic at low temperatures and thus rub against the knee more.

If the knee is out of position, the cartilage becomes very worn. Ligaments that are too short or muscular imbalances can increase this effect. Pain on the top of the kneecap often indicates a muscular imbalance. Pain under the kneecap is usually related to excessive pressure in the knee joint and consequential irritation to the patellar tendon

9.1.8 Pain in the foot

Your feet are one of three points of contact when you ride a pedelec. Feet transmit force from the upper thigh to the pedal, thus driving the pedelec. In the process, your feet are subjected to between 100% and, during jumps, even up to 1,000% of your body weight

Foot pain often arises when the saddle is too low or the foot is placed incorrectly on the pedal.

Unsuitable shoes can also be the cause of pain in the feet.

Solution

- Contact specialist dealer. Have the pedelec adjusted (see Section 6.5). Then measure the wheel.
- Avoid cold.



- Get imbalances under control through stretching exercises, strengthening the muscles and Blackroll training.

Solution

- Wear sturdy shoes which are not too tightly laced. (see Section 2.5)
- Position feet correctly on the pedals (see Section 6.13).
- Adjust the saddle height to an optimum position (see Section 6.5.4).

9.2 Troubleshooting and fault clearance

The components in the electric drive system are constantly checked automatically. If an error is detected, an error message appears on the *display*. The electric drive system may shut off automatically, depending on the type of error.

9.2.1 The electric drive system or display do not start up

If the display and/or the electric drive system do not start up, proceed as follows:

- 1 Check whether the battery is switched on. If not, start the battery.
- ⇒ Contact your specialist dealer if the LEDs on the **battery level indicator** do not light up.
- 2 If the LEDs on the **battery level indicator** light up, but the electric drive system does not start up, remove the battery.
- 3 Insert the battery.
- 4 Start the electric drive system.

- 5 If the electric drive system won't start, remove the battery.
- 6 Clean all the contacts with a soft cloth.
- 7 Insert the battery.
- 8 Start the electric drive system.
- 9 If the electric drive system won't start, remove the battery.
- 10 Fully charge the battery.
- 11 Insert the battery.
- 12 Start the electric drive system.
- 13 If the electric drive system does not start, **press the On-Off button (control panel) for at least 8 seconds.**
- 14 If the electric drive system does not start after about 6 seconds, **press the On-Off button (control panel) for at least 2 seconds.**
- 15 Contact your specialist dealer if the electric drive system won't start.

9.2.2 Warning messages and LEDs

All warning messages and the meaning of the different LEDs are explained in Section 6.2.

9.2.3 Errors in the assistance system

Symptom	Cause	Remedy
Assistance is not available.	Is the speed too high?	▶ Check on-screen indicators. The electronic gear assistance is only active up to a maximum speed of 25 km/h.
	Is the battery charged sufficiently?	1 Check battery is charged. 2 Recharge the battery if it is almost flat.
	The battery may become too hot during rides at high temperatures, up long inclines or when carrying a heavy load for a long time.	1 Switch off the electric drive system. 2 Wait a moment and then check again.
	The rechargeable battery, display or assistance switch may be connected incorrectly, or one or more of them may have a problem.	▶ Contact specialist dealer.
Assistance is not available.	Are the pedals being pushed?	▶ The pedelec is not a motorbike. Push the pedals.
	Is the system switched on?	▶ Press On-Off button (battery) to switch on the system.
	Is the assistance mode set to [OFF]?	1 Set the assistance mode to a different level of assistance than [OFF]. 2 Contact your specialist dealer if you still feel that the no assistance is being supplied.

Table 61: Error solution for assistance system

Symptom	Cause	Remedy
The assisted journey distance is too short.	The battery does not perform as well in winter weather.	This does not indicate a problem.
	The journey distance can be shorter depending on the road conditions, the gear level and the total light usage time.	<ol style="list-style-type: none"> 1 Check battery is charged. 2 Recharge the battery if it is almost flat.
	Is the battery fully charged?	▶ If the distance covered with a fully charged battery has become shorter, the battery may be affected. Replace the battery with a new one.
	The battery is a consumable. Repeated charging and long periods of use cause the battery to degrade (loss of power).	▶ If the distance you can cover with one single charge is very short, replace the battery with a new one.
It is difficult to pedal.	Are the tyres pumped to an adequate pressure?	▶ Pump up tyres.
	Is the assistance mode set to [OFF]?	▶ Set level of assistance to [HIGH], [STD], [ECO] or [AUTO].
	The battery charge might be low.	<ol style="list-style-type: none"> 1 Check battery is charged. 2 Recharge the battery if it is almost flat.
	Have you switched on the system with your foot on the pedal?	<ol style="list-style-type: none"> 1 Switch on the system again without applying pressure to the pedals. 2 If assistance is still not supplied, contact your specialist dealer.

Table 61: Error solution for assistance system

9.2.4 Battery error

Symptom	Cause	Remedy
The battery discharges very quickly.	The battery may be at the end of its useful life.	► Replace old battery with new one.
The battery cannot be recharged.	Is the charger mains plug firmly connected to the socket?	<ol style="list-style-type: none"> 1 Disconnect the charger mains plug. 2 Insert the mains plug. 3 Start charging.
	Is the charger plug firmly connected to battery?	<ol style="list-style-type: none"> 1 If the battery still won't recharge, disconnect the charger plug. 2 Insert charger plug. 3 Start charging.
	Is the adapter firmly connected to the charger plug or the battery's charging port?	<ol style="list-style-type: none"> 1 If you are still unable to recharge the battery, connect the adapter with the charger plug or the battery's charger connection. 2 Start charging.
	Is the connection terminal for the charger, charger adapter or battery dirty?	<ol style="list-style-type: none"> 1 If you are still unable to recharge the battery, wipe the connection terminals with a dry cloth to clean them. 2 Start charging. 3 If the battery still won't recharge, contact your specialist dealer.
The battery does not start charging when the charger is connected.	The battery may be at the end of its useful life.	► Replace old battery with new one.
The battery and charger become hot.	The battery or charger temperature may have exceeded the operating temperature range.	<ol style="list-style-type: none"> 1 Interrupt charging process. 2 Wait a moment. 3 Start charging. 4 If the battery is too hot to touch, there might be a problem with the battery. Contact specialist dealer.
The charger is hot.	If the charger is used continuously to charge batteries, it may become hot.	<ol style="list-style-type: none"> 1 Wait a moment. 2 Start charging.
The LED on the charger does not light up.	The LED on the charger will go out when the battery is fully charged.	This is not a malfunction.
	Is the charger plug firmly connected to battery?	<ol style="list-style-type: none"> 1 Check the connection for any contaminants. 2 Insert charger plug. 3 Contact your specialist dealer if there is no change.
	Is the battery fully charged?	<ol style="list-style-type: none"> 1 Disconnect the charger mains plug if there is no change. 2 Insert the mains plug. 3 Start charging. 4 Contact your specialist dealer if the LED on the charger still doesn't light up.
The battery cannot be removed.		► Contact specialist dealer.
The battery cannot be inserted.		► Contact specialist dealer.
Fluid is leaking from the battery.		► Observe all the warnings in Section 2 Safety.
There is an unusual smell.		<ol style="list-style-type: none"> 1 Remove the battery from the pedelec immediately. 2 Contact the fire service. 3 Observe all the warnings in Section 2 Safety.

Table 62: Error solution for battery

Symptom	Cause	Remedy
Fumes are emitted from the battery.		<ol style="list-style-type: none"> 1 Remove the battery from the pedelec immediately. 2 Contact the fire service. 3 Observe all the warnings in Section 2 Safety.

Table 62: Error solution for battery

9.2.5 On-board computer error

Symptom	Cause	Remedy
No data are shown on the on-board computer when you press the On-Off button on the battery.	The battery may not be charged enough.	<ol style="list-style-type: none"> 1 Charge the battery. 2 Switch on the power.
	Is the power switched on?	▶ Press the on-off button to switch the power on.
	Is the battery charged?	▶ If the battery is fitted to the pedelec and is being charged, it cannot be switched on. Interrupt charging.
	Is the connector fitted to the power cable correctly?	▶ Check that the power cable connector has not been disconnected. If this is not the case, contact your specialist dealer.
	A component may be connected which the system is unable to recognise.	▶ Contact specialist dealer.
The selected gear level is not shown on the on-board computer.	The gear level is only shown if the electronic gear shift is being used.	▶ Check that the power cable connector has not been disconnected. If this is not the case, contact your specialist dealer.
The gear shift will switch automatically when the pedelec starts up again after a stop.	In the case of pedelecs with an electronic hub gear, the pedelec is set to shift automatically into a gear that makes it easier to start after a stop ([start mode]).	This is not a malfunction.
The gear set in [Start mode] is not engaged when the pedelec is stopped.	You may have applied too much pressure on the pedals.	▶ It is easier to change gears if you pedal more gently.

Table 63: On-board computer error solution

9.2.6 Riding light does not work

Symptom	Cause	Remedy
The front light or rear light does not go on, even when the switch is pressed.	The basic settings in the electric drive system have probably been configured incorrectly. The light is faulty.	<ol style="list-style-type: none"> 1 Take pedelec out of service immediately. 2 Contact specialist dealer.

Table 64: Riding light error solution

9.2.7 Other electric drive system errors

Symptom	Cause	Remedy
Two beeps will sound if a switch is pressed but the switch cannot be operated.	Pressed switch mode has been deactivated.	► This is not a malfunction.
Three beeps are sounded.	A fault or warning has occurred.	► This occurs when a warning or an error is shown on the on-board computer. Follow the instructions for the code in Section 6.2 System Messages.
If an electronic gear shift is used, pedal assistance becomes less effective when the gear is changed.	This is because the computer sets the pedal assistance to the optimum level.	► This is not a malfunction.
A noise can be heard after switching.		► Contact specialist dealer.
It is normal to hear a noise coming from the rear wheel when cycling as normal.	The gear shift setting may not have been made properly.	► Contact specialist dealer.
If the pedelec is brought to a stop the pedelec, the gear transmission does not switch to the position pre-configured in the functional feature.	You may have applied too much pressure on the pedals.	► It is easier to change gears if you press onto the pedals gently.

Table 65: Other electric drive system errors

9.2.8 Problems with freewheel

Symptom	Cause	Remedy
Freewheel blocked.	Cover forgotten after fitting.	▶ Contact specialist dealer. Check installation correct.
	After fitting, socket was compressed by over-tightening the quick-release axle.	▶ Contact specialist dealer. Measure the length of the socket. If the socket is shorter than 15.4 mm, replace socket.
Freewheel does not lock into place or slips.	After maintenance: Too much or wrong grease on the toothed discs.	▶ Contact specialist dealer. Remove hub. Clean and grease toothed disc.
	Toothed discs are worn.	▶ Contact specialist dealer. Replace toothed disc.
	One or both springs were forgotten after fitting.	▶ Contact specialist dealer. Check installation correct.
	One or both toothed discs are fitted the wrong way round after assembly.	▶ Contact specialist dealer. Check installation correct.
Hub has axial clearance.	Ball bearings are worn	▶ Contact specialist dealer. Replace ball bearings.
	One or both toothed discs are fitted the wrong way round after assembly.	▶ Contact specialist dealer. Check installation correct.
Hub is stiff when turned.	Ball bearings are worn.	▶ Contact specialist dealer. Replace ball bearings.
	Ball bearings have been driven in too firmly after assembly	▶ Contact specialist dealer. Check installation correct.
	Installation sequence for ball bearings not observed.	▶ Contact specialist dealer. Check installation correct.
Hub makes noise	Ball bearings are worn	▶ Contact specialist dealer. Replace ball bearings.
Cassette caused notches on the freewheel body.	Steel cassette works its way into the aluminium bar on the freewheel body.	▶ Contact specialist dealer. Remove notches on the cassette surface with a file.
Freewheel body is stiff when turned.	Ball bearings in the freewheel body are worn.	▶ Contact specialist dealer. Replace freewheel body.
Freewheel is too loud or too quiet.	Perception of freewheel noise is subjective. While some pedelec riders prefer loud freewheel noise, others like a quite freewheel more.	▶ This is not a malfunction. The amount of grease between the toothed discs may have an effect on the freewheel noise. Less grease increases freewheel noise but also causes greater wear.

Table 66: Error solution for freewheel

9.2.9 Problems with hub gear

Symptom	Cause	Remedy
A noise is heard when the pedals are turning.	All gear speeds except 1.	▶ This is not a malfunction.
A noise is heard when the pedelec is pushed backwards.	All gear speeds except 1.	
Noises and vibrations occur on switching on.	All gear speeds.	
Gear shifting feels different, depending on the gear speed.	All gear speeds.	
A noise is heard whenever the rider isn't pedalling while riding.	All gear speeds.	
The gears are difficult to engage.	The cable has not been installed properly.	▶ Contact specialist dealer.
	The gear shift unit has been set to the override state.	▶ Contact specialist dealer. (readjust gear shift unit)
Gears cannot be engaged smoothly.	Shift cable tension setting not correct.	▶ Carefully pull the <i>adjusting sleeve</i> away from the shifter housing, turning it as you do so. ▶ Check the gear shift function after each adjustment.
The gear speed cannot be changed.	The cable was not set correctly.	▶ Contact specialist dealer. (Reset gear shift unit; check whether the gear speed can be changed when the wheel is detached from the frame.)
Strange noises are produced	When switching gears	▶ Contact specialist dealer.
	When pedalling	
The gear speed shown on the indicator differs from the speed in the hub.	The cable was not set correctly.	▶ Contact specialist dealer.
	The internal unit has a defect.	
The hub rotates with difficulty only or does not rotate smoothly.	The cone is firmly positioned.	▶ Contact specialist dealer.
	The internal unit has a defect.	▶ Contact specialist dealer.
A rattling noise is heard when pedalling.	The section around the cone is damaged.	▶ Contact specialist dealer.
Free rotation is not smooth if the rider does not pedal.		▶ Contact specialist dealer.
The brakes are too sensitive.		▶ Contact specialist dealer.
The brakes are not strong enough.		▶ Contact specialist dealer.
The rider needs to push the pedals too far back before the brakes engage.		▶ Contact specialist dealer.
The wheels block if the pedelec is pushed backwards.		▶ Contact specialist dealer.

Table 67: Error solution for limit stop

Symptom	Cause	Remedy
Strange noises occur when the brakes are applied.		▶ Contact specialist dealer.
Rotation feels stiff during free rotation.		▶ Contact specialist dealer.
Chain jumps between the gearwheels when gear is changed.	Gearwheels and/or chain worn.	▶ Contact specialist dealer. New chain, gearwheels or hub.

Table 67: Error solution for limit stop

9.2.10 Problems with disc brakes

Symptom	Cause	Remedy
Ringing and unusual sounds from disc brakes.	Riding on asphalt with off-road tyres.	▶ Contact specialist dealer. Fit a city or trekking tyre.
Low braking power from the disc brake.	Dirty or greasy brake disc.	▶ Clean brake disc thoroughly with white spirit or brake cleaner.
	Worn brake disc or brake lining, brake lining vitrified.	▶ Contact specialist dealer.
Metallic noises from disc brake.	Worn brake linings.	▶ Contact specialist dealer. New brake linings and brake disc.
Spongy, soft or poor pressure point in disc brakes.	Brake calliper fitted incorrectly, brake disc loose, brake disc or brake lining worn or brake system leaking.	▶ Contact specialist dealer.
Noises when rim brake is applied.	Dirt.	1 Clean brake disc and brake thoroughly. 2 If the problem is not solved, contact your specialist dealer.
	Worn or wrong brake linings.	▶ Contact specialist dealer. New brake linings and brake discs.
	Wheel, hub or axle fitted incorrectly.	▶ Contact specialist dealer. Check brake system and wheel assembly.
	Brake calliper and/or brake disc fitted incorrectly.	
	Incorrect torques.	
	Brake disc damaged by side impact.	
	Vitrified brake linings.	
	Brake system leaking.	
Incorrect torques.		
Incorrect brake mount height.		

Table 68: Disc brake error solution

9.2.11 Problems with rim brakes

Symptom	Cause	Remedy
Noises when rim brake is applied.	Break in brakes. A rim brake's full braking power is not produced until the rider has cycled several kilometres.	► This is not a malfunction. During the first 50 km or so after replacing the brake linings, check the rims and brake linings regularly and clean to remove any residues.
	Dirt.	1 Clean rim and brake thoroughly. 2 If the problem is not solved, contact your specialist dealer.
	Worn or wrong brake linings.	► Contact specialist dealer. New brake linings and rims.
	Wheels, hub or axle fitted incorrectly.	► Contact specialist dealer. Check brake system and wheel assembly.
	Incorrect torques.	
	Incorrect brake mount height.	

Table 69: Rim brake error solution

9.2.12 Problems with back-pedal brake

Symptom	Cause	Remedy
Brake is too sensitive.		<ol style="list-style-type: none"> 1 Contact specialist dealer. Lubricate brake hub. 2 Replace brake shoe unit.
Brake is too weak.		<ol style="list-style-type: none"> 1 Contact specialist dealer. Replace brake shoe unit. 2 If the problem should persist, replace the internal hub unit.
The rider needs to push the pedals too far back before the brakes engage.		<ol style="list-style-type: none"> 1 Contact specialist dealer. Replace brake shoe unit. 2 If the problem should persist, replace the internal hub unit.
The wheels block if the pedelec is pushed backwards.		<ul style="list-style-type: none"> ▶ Contact specialist dealer. Replace internal hub unit.
Unusual noises when braking		<ol style="list-style-type: none"> 1 Contact specialist dealer. Lubricate brake hub. 2 Replace brake shoe unit.
Rotation feels stiff during free rotation.		<ul style="list-style-type: none"> ▶ Contact specialist dealer. Replace brake shoe unit.

Table 70: Error solution for back-pedal brake

9.2.13 SR SUNTOUR suspension fork

9.2.13.1 Rebound too fast

The suspension fork rebounds too quickly, producing a "pogo stick" effect, where the wheel lifts from the ground in an uncontrolled way. This impairs traction and control (blue line).

Fork head and handlebars are deflected upwards if the wheel bounces back from the ground. Body weight may be thrown up and back in an uncontrolled way (green line).



Figure 197: Suspension fork rebounding too quickly

Solution



Figure 198: SR SUNTOUR rebound screw (1)

► Turn **rebound screw** in a clockwise direction.

⇒ The rebound speed is decreased (slower return).

9.2.13.2 Rebounding too slowly

The fork does not rebound quickly enough after absorbing a bump. The fork also remains deflected over subsequent bumps, which reduces deflection and increases the hardness of impacts. Available deflection, traction and control decrease (blue line).

The fork remains in a deflected state, causing the headset and handlebars to move to a lower position. Body weight is shifted forward after the impact (green line).

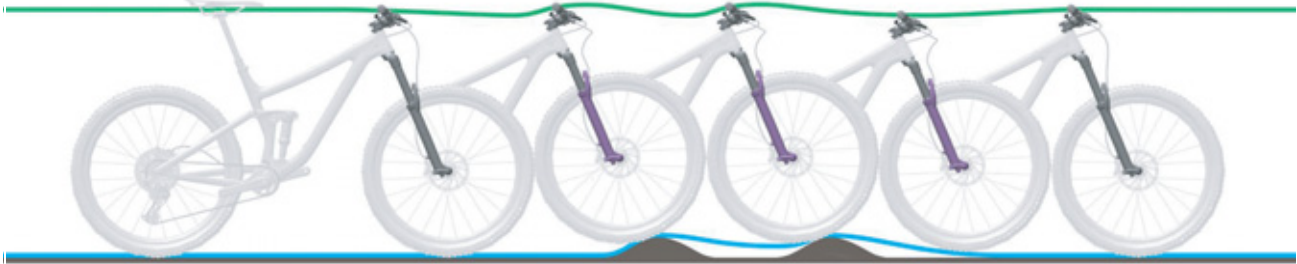

Figure 199: Suspension fork rebounding too slowly

Solution



Figure 200: SR SUNTOUR rebound screw (1)

- ▶ Turn **rebound screw** in an anti-clockwise direction.
- ⇒ The rebound speed is increased (faster return).

9.2.13.3 Suspension too soft on inclines

The fork deflects at a low point in the terrain. The deflection is quickly used up, body weight shifts forward and the pedelec loses some momentum.

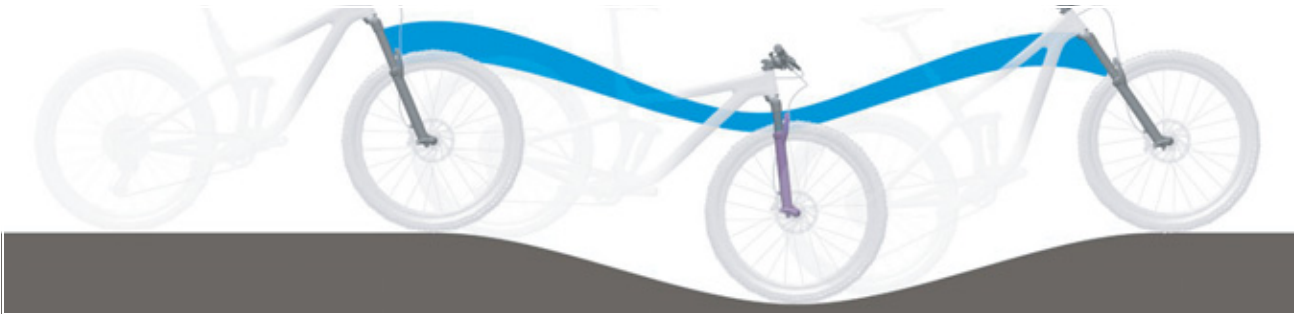

Figure 201: Excessively soft suspension in the suspension fork on hilly terrain

Solution



Figure 202: Changing compression adjuster to a harder setting

- ▶ Turn **compression adjuster** in a clockwise direction towards LOCK.
- ⇒ The damping and compression hardness are increased and the deflection stroke speed. Efficiency on hilly and flat terrain is improved.

9.2.13.4 Excessively hard damping on bumps

When the bike hits a bump, the fork deflects too slowly and the wheel lifts up from the bump. Traction decreases when the wheel no longer touches the ground.

The headset and handlebars are deflected upwards significantly, which can impair control.

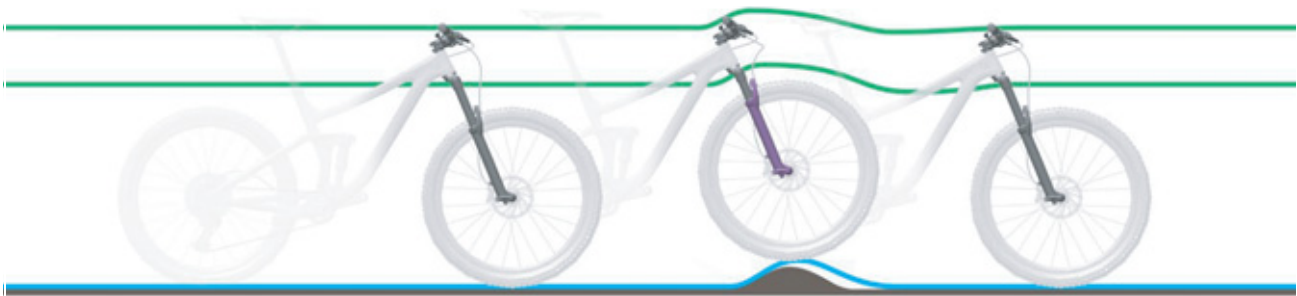

Figure 203: Excessively hard damping in the suspension fork on bumps

Solution

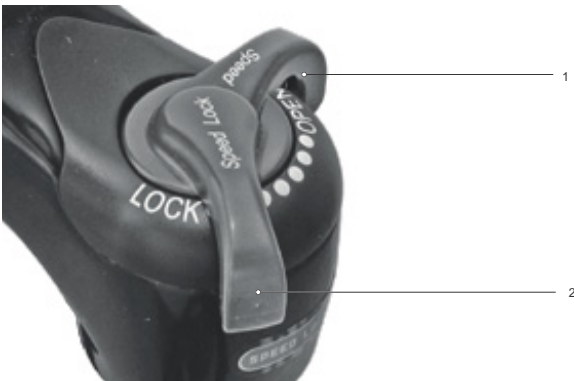

Figure 204: Changing compression adjuster to a softer setting

- ▶ Turn **compression adjuster** in a clockwise direction towards OPEN.
- ⇒ The damping and compression hardness reduces and the deflection stroke speed is reduced. Sensitivity to small bumps is increased.

9.2.14 RockShox suspension fork

9.2.14.1 Rebound too fast

The suspension fork rebounds too quickly, producing a "pogo stick" effect, where the wheel lifts from the ground in an uncontrolled way. This impairs traction and control (blue line).

Fork head and handlebars are deflected upwards if the wheel bounces back from the ground. Body weight may be thrown up and backwards in an uncontrolled way (green line).



Figure 205: Suspension fork rebounding too quickly

Solution

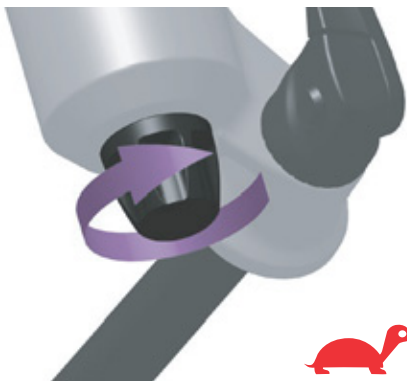

Figure 206: Turning the rebound screw damper towards tortoise symbol

- ▶ Turn the rebound screw clockwise towards the tortoise symbol.
- ⇒ The rebound speed is decreased (slower return).

9.2.14.2 Rebounding too slowly

The fork does not rebound quickly enough after absorbing a bump. The fork also remains deflected over subsequent bumps, which reduces deflection and increases the hardness of impacts. Available deflection, traction and control decrease (blue line).

The fork remains in a deflected state, causing the headset and handlebars to move to a lower position. Body weight is shifted forward after the impact (green line).



Figure 207: Suspension fork rebounding too slowly

Solution



Figure 208: Turning the rebound screw damper towards hare symbol

- ▶ Turn the rebound screw anti-clockwise towards the hare symbol.
- ⇒ The rebound speed is increased (fast return).

9.2.14.3 Suspension too soft on inclines

The fork deflects at a low point in the terrain. The deflection is quickly used up, body weight shifts forward, and the pedelec loses some momentum.

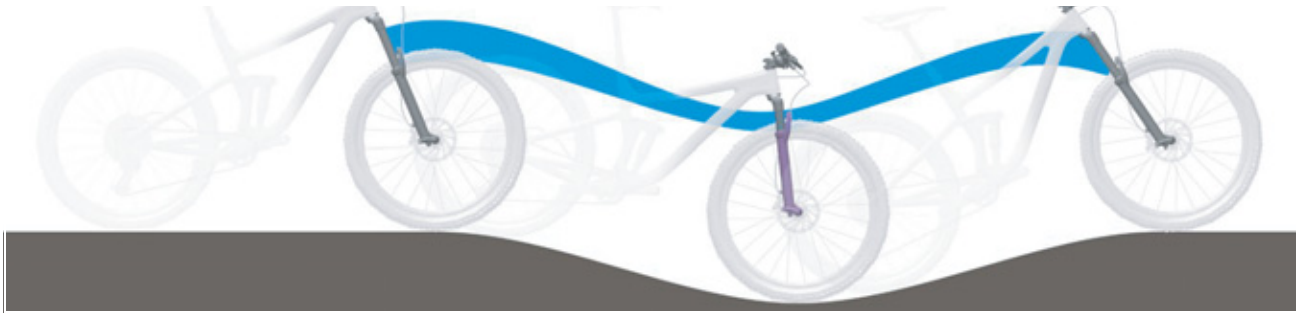

Figure 209: Excessively soft suspension in the suspension fork on hilly terrain

Solution



Figure 210: Changing compression adjuster to a harder setting

- ▶ Turn compression adjuster clockwise.
- ⇒ The damping and compression hardness is increased, and the deflection stroke speed is reduced. Efficiency on hilly and flat terrain is improved.

9.2.14.4 Excessively hard damping on bumps

When the bike hits a bump, the fork deflects too slowly and the wheel lifts up from the bump. Traction decreases when the wheel no longer touches the ground.

The headset and handlebars are deflected upwards significantly, which can impair control.



Figure 211: Excessively hard damping in the suspension fork on bumps

Solution



Figure 212: Adjust the compression adjuster so that it is softer

- ▶ Turn **compression adjuster** anti-clockwise.
- ⇒ The damping and compression hardness is reduced and the deflection stroke speed is increased. Sensitivity to small bumps is increased.

9.2.15 Rear frame damper

9.2.15.1 Rebound too fast

The rear frame damper rebounds too quickly, producing a "pogo stick" effect or causing the bike to bounce after the wheel hits a bump and lands on the ground again. This impairs traction and control due to the uncontrolled speed at which the damper rebounds after deflecting (blue line).

Saddle and handlebars are deflected upwards when the wheel bounces back from the ground. The rider's body weight may be shifted upwards and forwards if the damper fully rebounds too quickly (green line).



Figure 213: Rear frame damper rebounding too quickly

Solution



Figure 214: SR SUNTOUR rebound adjuster wheel (1) on the rear frame damper

- ▶ Turn **rebound wheel** towards plus.
- ⇒ The deflection movement is reduced.

9.2.15.2 Rebounding too slowly

The rear frame damper does not rebound quickly enough after a bump has been compensated and is not in the required initial position when the wheel hits the next bump. The rear frame damper remains compressed during successive bumps, thus reducing deflection and ground contact and increasing hardness on the next impact. The rear wheel bounces off the second bump since the rear frame damper does not rebound quickly enough to make contact with the ground and return to the initial position again. The available deflection and traction are reduced (blue line).

The rear frame damper remains in a deflected state after contact with the first bump. When the rear wheel hits the second bump, the saddle follows the path of the rear wheel instead of remaining in a horizontal position. The available deflection and potential absorption of bumps are reduced, which causes instability and loss of control during successive bumps (green line).

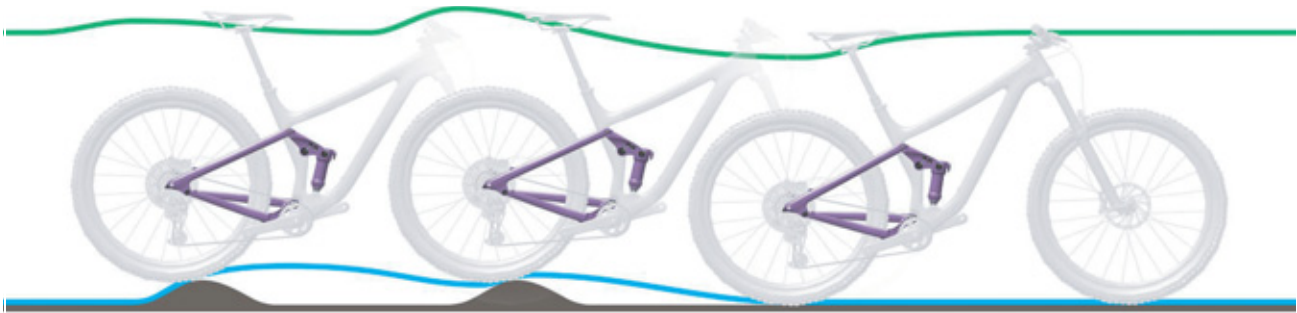

Figure 215: Rear frame damper rebounding too slowly

Solution



Figure 216: SR SUNTOUR rebound adjuster wheel (1) on the rear frame damper

- ▶ Turn **rebound wheel** towards minus.
- ⇒ The rebound movement is increased.

9.2.15.3 Suspension too soft on inclines

The rear frame damper deflects deeply through the deflection range. The deflection is quickly used

up, body weight shifts downwards and the pedelec loses some momentum.



Figure 217: Excessively soft suspension in the rear frame damper on hilly terrain

Solution

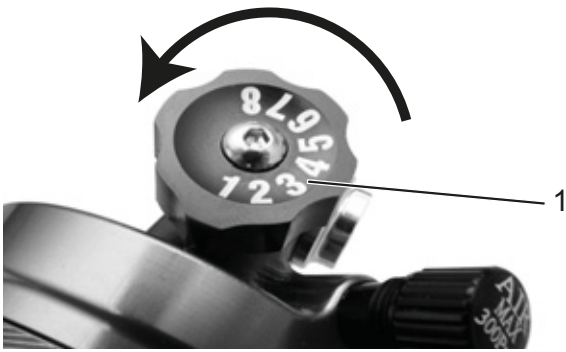

Figure 218: SR SUNTOUR compression adjuster (1) on the rear frame damper

► Turn **compression adjuster** clockwise.

⇒ The damping and compression hardness is increased, and the deflection stroke speed is reduced. Efficiency on hilly and flat terrain is improved.

9.2.15.4 Excessively hard damping on bumps

When the bike hits a bump, the damper deflects too slowly and the rear wheel lifts up from the bump. Traction is reduced (blue line).

Saddle and pedelec rider are deflected upwards and forwards, the rear wheel loses contact with the ground and control is reduced (green line).



Figure 219: Excessively hard damping in the rear frame damper on bumps

Solution

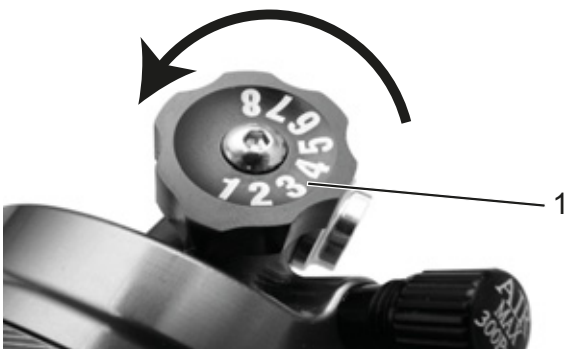

Figure 220: SR SUNTOUR compression adjuster (1) on the rear frame damper

- ▶ Turn **compression adjuster** anti-clockwise.
- ⇒ The damping and compression hardness is reduced and the deflection stroke speed is increased. Sensitivity to small bumps is increased.

9.2.16 RockShox rear frame damper

9.2.16.1 Rebound too fast

The rear frame damper rebounds too quickly, producing a "pogo stick" effect or causing the bike to bounce after the wheel hits a bump and lands on the ground again. This impairs traction and control due to the uncontrolled speed at which the damper rebounds after deflecting (blue line).

Saddle and handlebars are deflected upwards when the wheel bounces back from the ground. The rider's body weight may be shifted upwards and forwards if the damper fully rebounds too quickly (green line).



Figure 221: Rear frame damper rebounding too quickly

Solution

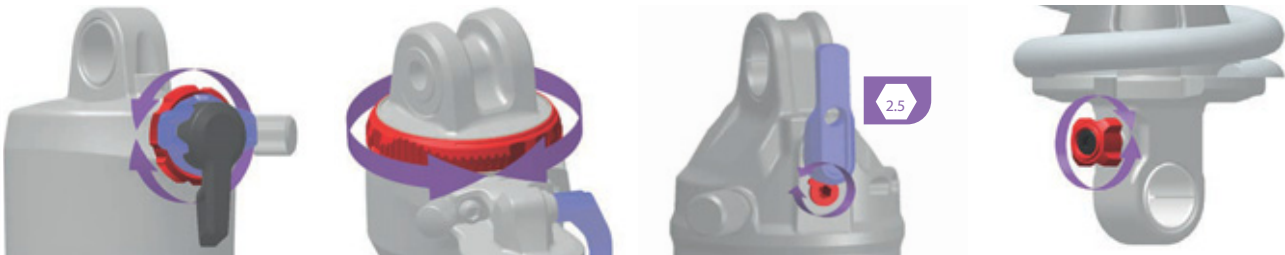

Figure 222: Position and shape of the rebound adjuster (red) depends on the model

- ▶ Turn **rebound adjuster** in a clockwise direction.
- ⇒ Rebound damping is increased. The rebound speed is reduced and traction and control is increased.

9.2.16.2 Rebounding too slowly

The rear frame damper does not rebound quickly enough after a bump has been compensated and is not in the required initial position when the wheel hits the next bump. The rear frame damper remains compressed during successive bumps, thus reducing deflection and ground contact and increasing hardness on the next impact. The rear wheel bounces off the second bump since the rear frame damper does not rebound quickly enough to make contact with the ground and return to the initial position again. The available deflection and traction are reduced (blue line).

The rear frame damper remains in a deflected state after contact with the first bump. When the rear wheel hits the second bump, the saddle follows the path of the rear wheel instead of remaining in a horizontal position. The available deflection and potential absorption of bumps are reduced, which causes instability and loss of control during successive bumps (green line).

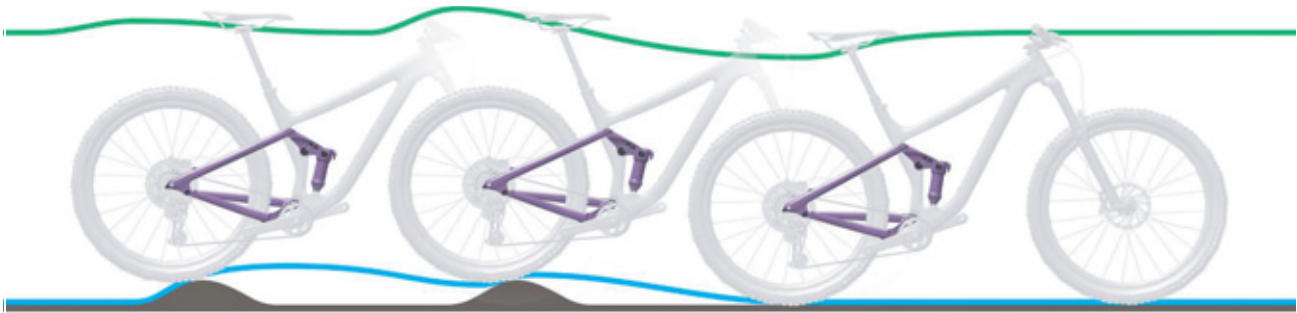

Figure 223: Rear frame damper rebounding too slowly

Solution

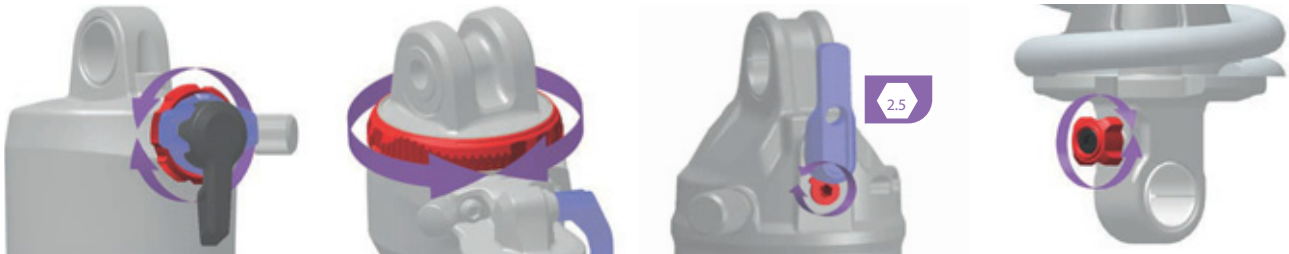

Figure 224: Position and shape of the rebound adjuster (red) depends on the model

- ▶ Turn **rebound adjuster** in an anti-clockwise direction.
- ⇒ Rebound damping is reduced. The rebound speed is increased. Performance while riding over bumps is improved.

9.2.16.3 Suspension too soft on inclines

The rear frame damper deflects deeply through the deflection range. Deflection is quickly used up,

to the pedelec rider's weight shifts forward and the pedelec loses some momentum.



Figure 225: Excessively soft suspension in the rear frame damper on hilly terrain

Solution

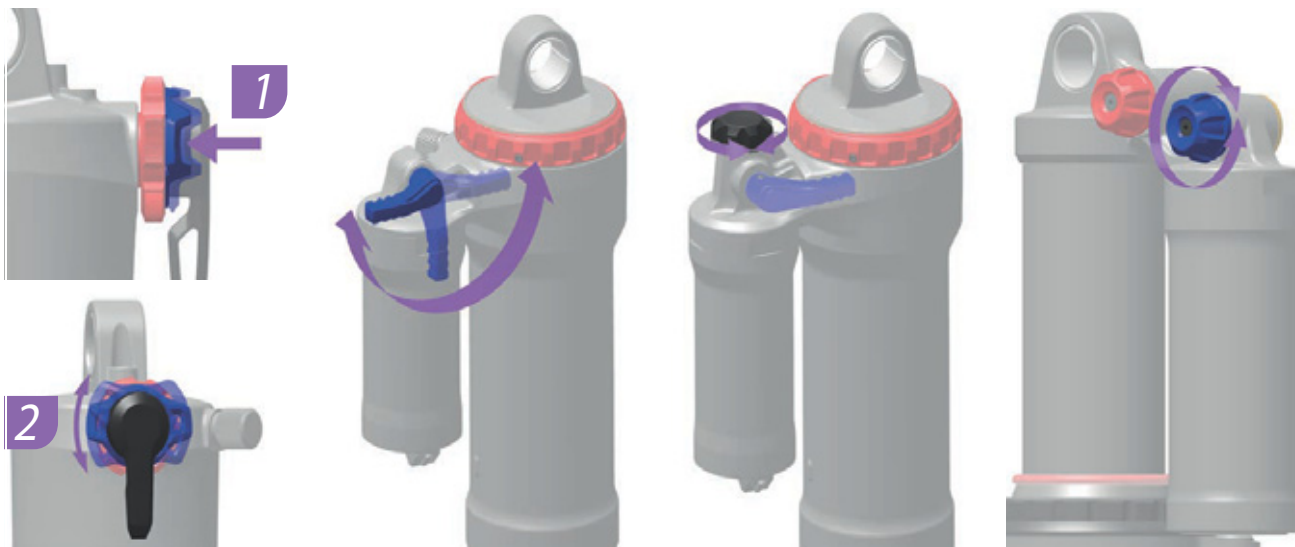

Figure 226: Position and shape of the compression adjuster (blue) depends on the model

► Turn **compression adjuster** clockwise.

⇒ The damping and compression hardness is increased, and the deflection stroke speed is reduced.

9.2.16.4 Excessively hard damping on bumps

When the bike hits a bump, the damper deflects too slowly and the rear wheel lifts up from the bump. Traction is reduced (blue line).

Saddle and pedelec rider are deflected upwards and forwards, the rear wheel loses contact with the ground and control is reduced (green line).



Figure 227: Excessively hard damping in the rear frame damper on bumps

Solution

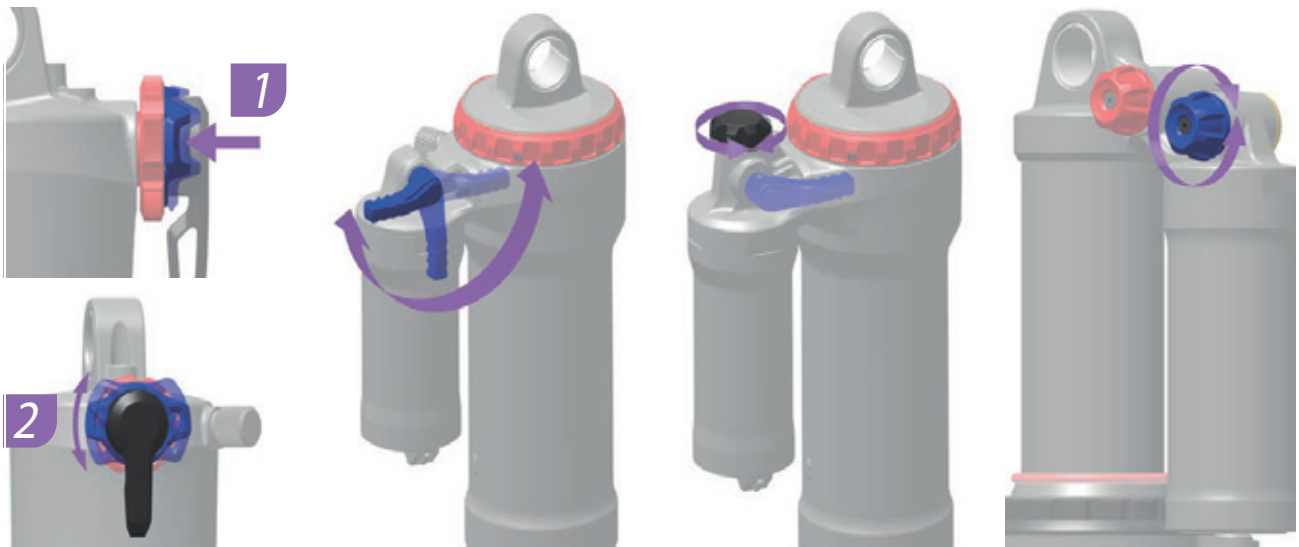

Figure 228: Position and shape of the compression adjuster (blue) depends on the model

- ▶ Turn **compression adjuster** anti-clockwise.
- ⇒ The damping and compression hardness is reduced and the deflection stroke speed is increased. Sensitivity to small bumps is increased.

9.2.17 Other errors

Symptom	Cause	Remedy
Two beeps will sound if a switch is pressed but the switch cannot be operated.	Pressed switch mode has been deactivated.	▶ This is not a malfunction.
Three beeps are sounded.	A fault or warning has occurred.	▶ This occurs when a warning or an error is shown on the on-board computer. Follow the instructions for the code in Section 6.2 System Messages.
If an electronic gear shift is used, pedal assistance becomes less effective when the gear is changed.	This is because the computer sets the pedal assistance to the optimum level.	▶ This is not a malfunction.
A noise can be heard after switching.		▶ Contact specialist dealer.
It is normal to hear a noise coming from the rear wheel when cycling as normal.	The gear shift setting may not have been made properly.	▶ Contact specialist dealer.
If the pedelec is brought to a stop the pedelec, the gear transmission does not switch to the position pre-configured in the functional feature.	You may have applied too much pressure on the pedals.	▶ Press on the pedals only gently to make it easier to change the transmission.

Table 71: Other drive system errors

9.3 Repair

Special expertise and tools are required for many repairs. For this reason, repairs may only be carried out at a specialist dealer. These include:

- Replacing tyre, tube and spokes
- Replace brake linings, rims and brake discs
- Replace and tension the chain.

9.3.1 Original parts and lubricants

The individual pedelec parts have been carefully selected and matched to one other.

Only original parts and lubricants must be used for maintenance and repair.

The constantly updated accessory approval and parts lists are in Section 11, Documents and Drawings.

- ▶ Follow the operating instructions for the new components.

9.3.2 Repairing the frame

9.3.2.1 Removing paint damage on frame

- 1 Gently sand paintwork damage with 600-grit sandpaper.
- 2 Smooth edges.
- 3 Apply one or two coats of repair paint.

9.3.2.2 Removing damage from impact on the carbon frame

There may be damage to the laminate beneath the paintwork in the case of impact. The frame may break even under light stress.

- 1 Take pedelec out of service.
- 2 Send frame to a fibre composite repair company or purchase new frame as specified in the parts list.

9.3.3 Repairing the suspension fork

9.3.3.1 Removing paint damage on the fork

- 1 Gently sand paintwork damage with 600-grit sandpaper.
- 2 Smooth edges.
- 3 Apply one or two coats of repair paint.

9.3.3.2 Removing damage from impact on the carbon frame

There may be damage to the laminate beneath the paintwork in the case of impact. The fork may break even under light stress.

- ▶ Take pedelec out of service. New fork as specified in the parts list.
 - ⇒ The fork must be free from any defects.
- 4 Clean inside and exterior.
 - 5 Grease fork.
 - 6 Install fork.

9.3.3.3 Repairing the seat post

Repairing paint damage on the seat post

- 1 Gently sand paintwork damage with 600-grit sandpaper.
- 2 Smooth edges.
- 3 Apply one or two coats of repair paint.

9.3.3.4 Repairing damage from impact on the carbon post seat post

There may be damage to the laminate beneath the paintwork in the case of impact. The carbon seat post may break even under light stress.

- 1 Take pedelec out of service.
- 2 New carbon seat post as specified in parts list.

9.3.4 Replacing the riding light

- ▶ Only use components in the corresponding power class for replacement.

9.3.5 Adjusting the headlight

- ▶ The *headlight* must be positioned so that its light beam shines on the road 10 m in front of the pedelec (see Section 6.4).

9.3.6 Checking suspension fork-tyre clearance

The tyre clearance needs to be checked each time a suspension fork tyre is replaced.

- 1 Release pressure from the fork.
- 2 Press fork together fully.
- 3 Measure the gap between the top of the tyre and the crown's lower surface. The gap must not be less than 10 mm. If the tyre is too large, the tyre will touch the crown's lower surface when the fork is fully pressed together.
- 4 Release pressure on fork and pump it up again if it is an air suspension fork.
- 5 Take into account the fact that the gap will be smaller if there is a guard. Check again to ensure that there is sufficient clearance for the tyre.

10 Recycling and disposal



This device is marked according to the European Directive 2012/19/EU on waste electrical and electronic equipment – WEEE and the European Directive 2006/66/EC on accumulators.

The directive provides the framework for the return and recycling of used devices across the EU. Consumers are legally required to return all used batteries of any type. It is forbidden to dispose of batteries in domestic waste.

The battery manufacturer is legally obliged to take back used and old batteries free of charge according to Section 9 German Batteries Act. The pedelec frame, battery, motor, on-board computer and charger are recyclable materials. You must dispose of and recycle them separately from the domestic waste in compliance with applicable statutory regulations. Separate collection and

recycling saves reserves of raw materials and ensures that all the regulations for protection of health and the environment are adhered to when recycling the product and/or the battery.

- ▶ Never dismantle the pedelec, battery or charger for disposal.

The pedelec, on-board computer, the unopened and undamaged battery and the charger can be returned to any specialist dealer free of charge. Further disposal options may be available, depending on the region.

- ▶ Store the individual parts of the decommissioned pedelec in a dry place, free from frost, where they are protected from direct sunlight.

10.1 Guidelines on removal of waste

Waste type	Disposal
Non-hazardous waste	
 Recycling	
Waste paper, cardboard	Return paper collection bin, paper container, undamaged transport packaging to suppliers
Scrap metal and aluminium	Take to municipal collection points or have collected by waste disposal companies
Tyres, tubes	Tyre manufacturers' collection points, collection forms and fax templates available from tyre manufacturer Otherwise, residual waste bin (grey bin)
Fibre composite components (e.g. carbon, GRP)	Large carbon components such as defective frames and carbon rims can be sent to special collection points for recycling; see www.cfk-recycling.de/index.php?id=57
Dual system sales packaging made of plastic, metal and composite material, lightweight packaging	Collection by waste disposal firm where applicable; return transport packaging to suppliers Plastic waste bin (yellow bin)
CDs, DVDs	Take to municipal collection points since they are made of high-grade plastic and are easy to recycle Otherwise, residual waste bin (grey bin)

Table 72: Removal of waste guidelines

Waste type	Disposal
Dispose of	
Residual waste	Residual waste bin (grey bin)
Biodegradable lubricants Biodegradable oils Cleaning cloths covered in biodegradable oil	Residual waste bin (grey bin)
Filament lamps, halogen lamps	Residual waste bin (grey bin)
Hazardous waste	
 Recycling	
Batteries, rechargeable batteries	Return to the battery manufacturer.
Electric devices: Motor Display Control panel Wiring	Take to a municipal collection point for electronic waste
Dispose of	
Waste oil Cleaning cloths daubed in oil Lubrication oil Gear oil Lubricating grease Cleaning fluids Kerosene White spirit Hydraulic fluid Brake fluid	Never mix different oil fluids. Store in original container. Small amounts (mainly <30 kg) Take to municipal collection points for hazardous waste (e.g. mobile toxic waste collection service) Larger quantities (>30 kg) Collection by waste disposal companies
Paints Varnishes Thinners	Take to municipal collection points for hazardous waste (e.g. mobile toxic waste collection service)
Neon lights, energy-saving lamps	Take to municipal collection points for hazardous waste (e.g. mobile toxic waste collection service)

Table 72: Removal of waste guidelines



11 Documents

11.1 Assembly report

Date:

Frame number:

Components	Description	Tests	Criteria		Measures if rejected
			Acceptance	Rejection	
Front wheel	Assembly		O.K.	Loose	Adjust quick release
Kickstand	Check mount fastening	Functional check	O.K.	Loose	Retighten screws
Tyres		Tyre pressure check	O.K.	Tyre pressure too low/ too high	Adjust tyre pressure
Frame	Check for damage – fracture, scratches		O.K.	Damage detected	<i>Take out of operation</i> , new frame
Handles, coverings	Check mount fastening		O.K.	Not provided	Retighten screws, new handles and coverings as specified in parts list
Handlebars, stem	Check mount fastening		O.K.	Loose	Retighten screws; new stem as specified in parts list if necessary
Steering headset	Check for damage	Functional check	O.K.	Loose	Retighten screws
Saddle	Check mount fastening		O.K.	Loose	Retighten screws
Seat post	Check mount fastening		O.K.	Loose	Retighten screws
Guard	Check mount fastening		O.K.	Loose	Retighten screws
Pannier rack	Check mount fastening		O.K.	Loose	Retighten screws
Attachments	Check mount fastening		O.K.	Loose	Retighten screws
Bell		Functional check	O.K.	No ring, too quiet, missing	New bell as specified in the parts list
Suspension elements					
Fork, suspension fork	Check for damage		O.K.	Damage detected	New fork as specified in the parts list
Rear frame damper	Check for damage		O.K.	Damage detected	New fork as specified in the parts list
Suspension seat post	Check for damage		O.K.	Damage detected	New fork as specified in the parts list
Brake system					
Handbrake	Check mount fastening		O.K.	Loose	Retighten screws
Brake fluid	Check fluid level		O.K.	Too little	Refill with brake fluid; new brake hoses if damaged
Brake linings	Check brake linings, brake discs and rims for damage		O.K.	Damage detected	New brake linings, brake discs and rims
Back-pedal brake braking armature	Check mount fastening		O.K.	Loose	Retighten screws
Lighting system					
Rechargeable battery	First examination		O.K.	Error message	<i>Take out of service</i> ; contact battery manufacturer, new battery
Light cabling	Connections, correct wiring		O.K.	Cable defective, no light	New cabling
Rear light	Side light	Functional check	O.K.	No constant light	<i>Take out of service</i> ; new rear light as specified in parts list; replace if necessary
Front light	Side light, daytime riding light	Functional check	O.K.	No constant light	<i>Take out of service</i> ; new front light as specified in parts list; replace if necessary
Reflectors	All complete, state, fastening		O.K.	Damaged or not all complete	New reflectors



Drive/gear shift					
Chain/cassette/pinion/chaining	Check for damage		O.K.	Damage	Refasten if necessary or replace as specified in parts list
Chain guard/spoke guard	Check for damage		O.K.	Damage	Replace as specified in parts list
Bottom bracket axle/crank	Check mount fastening		O.K.	Loose	Retighten screws
Pedals	Check mount fastening		O.K.	Loose	Retighten screws
Shifter	Check mount fastening	Functional check	O.K.	Loose	Retighten screws
Shift cables	Check for damage	Functional check	O.K.	Loose and defective	Adjust shift cables; new shift cables if necessary
Front derailleur	Check for damage	Functional check	O.K.	Switching gears difficult or not possible	Adjust
Rear derailleur	Check for damage	Functional check	O.K.	Switching gears difficult or not possible	Adjust
Electric drive					
On-board computer	Check for damage	Functional check	O.K.	No screen, defective screen display	Restart, test battery, new software or new on-board computer; <i>take out of service</i> ,
Control panel	Control panel Check for damage	Functional check	O.K.	No response	Restart; contact control panel manufacturer, new control panel
Tachometer		Speed measurement	O.K.	Pedelec travelling 10% too fast/slow	Take pedelec out of service until the source of the error is found
Cabling	Visual inspection		O.K.	Failure in system, damage, kinked cables	New cabling
Battery mount	Firmly in position, lock, contacts	Functional check	O.K.	Loose; lock doesn't close, no contacts	New battery mount
Motor	Visual inspection and mount		O.K.	Damage, loose	Refasten motor, contact motor manufacturer, new motor
Software	Check version		In latest version	Not latest version	Import update

Technical inspection, checking safety, test ride

Components	Description		Criteria		Measures if rejected
	Assembly/inspection	Tests	Acceptance	Rejection	
Brake system		Functional check	O.K.	No full braking; braking distance too long	Locate defective part in brake system and correct
Gear shift under operating load		Functional check	O.K.	Problems when shifting gear	Readjust gear shift
Suspension components (fork, shock absorber, seat post)		Functional check	O.K.	Suspension too deep or no longer exists	Locate defective component and correct
Electric drive system		Functional check	O.K.	Loose connection, problems when riding, accelerate	Locate faulty components in electric drive and remedy
Lighting system		Functional check	O.K.	No continuous light, not bright enough	Locate defective part in lighting system and correct
Test ride			No strange noises	Strange noises	Locate source of noise and correct

Date:	
Fitter's name:	
Final inspection by workshop manager:	



11.2 Inspection and maintenance log

Diagnosis and documentation of current status

Date:

Frame number:

Components	Frequency	Description			Criteria		Measures if rejected
		Inspection	Tests	Inspection/maintenance	Acceptance	Rejection	
Front wheel	6 months	Assembly			O.K.	Loose	Adjust quick release
Kickstand	6 months	Check mount fastening	Functional check		O.K.	Loose	Retighten screws
Tyres	6 months		Tyre pressure check		O.K.	Tyre pressure too low/too high	Adjust tyre pressure
Frame	6 months	Check for damage – fracture, scratches			O.K.	Damage detected	Take pedelec out of service, new frame
Handles, coverings	6 months	Wear; check if fastened securely			O.K.	Not provided	Retighten screws, new handles and coverings as specified in parts list
Handlebars, stem	6 months	Check mount fastening			O.K.	Loose	Retighten screws; new stem as specified in parts list if necessary
Steering headset	6 months	Check for damage	Functional check	Lubricating and adjustment	O.K.	Loose	Retighten screws
Saddle	6 months	Check mount fastening			O.K.	Loose	Retighten screws
Seat post	6 months	Check mount fastening			O.K.	Loose	Retighten screws
Guard	6 months	Check mount fastening			O.K.	Loose	Retighten screws
Pannier rack	6 months	Check mount fastening			O.K.	Loose	Retighten screws
Attachments	6 months	Check mount fastening			O.K.	Loose	Retighten screws
Bell	6 months		Functional check		O.K.	No ring, too quiet, missing	New bell as specified in the parts list
Suspension elements							
Fork, suspension fork	To manufacturer's specifications*	Check for damage, corrosion, fracture		Maintenance as specified by manufacturer Lubrication, oil change as specified by manufacturer	O.K.	Damage detected	New fork as specified in the parts list
Rear frame damper	To manufacturer's specifications*	Check for damage, corrosion, fracture		Maintenance as specified by manufacturer Lubrication, oil change as specified by manufacturer	O.K.	Damage detected	New fork as specified in the parts list
Suspension seat post	To manufacturer's specifications*	Check for damage		Maintenance as specified by manufacturer	O.K.	Damage detected	New fork as specified in the parts list



Components	Frequency	Description			Criteria		Measures if rejected
		Inspection	Tests	Maintenance	Acceptance	Rejection	
Brake system							
Handbrake	6 months	Check mount fastening			O.K.	Loose	Retighten screws
Brake fluid	6 months	Check fluid level		Depending on time of year	O.K.	Too little	Top up brake fluid; take Pedelec out of service if damaged; new brake hoses
Brake linings	6 months	Check brake linings, brake discs and rims for damage			O.K.	Damage detected	New brake linings, brake discs and rims
Back-pedal brake braking armature	6 months	Check mount fastening			O.K.	Loose	Retighten screws
Brake system	6 months	Check mount fastening		Functional check	O.K.	Loose	Retighten screws
Lighting system							
Rechargeable battery	6 months	First examination			O.K.	Error message	Contact battery manufacturer; take battery out of use; new battery
Light cabling	6 months	Connections, correct wiring			O.K.	Cable defective, no light	New cabling
Rear light	6 months	Side light	Functional check		O.K.	No constant light	New rear light as specified in parts list; replace if necessary
Headlight	6 months	Side light, daytime riding light	Functional check		O.K.	No constant light	New headlight light as specified in parts list; replace if necessary
Reflectors	6 months	All complete, state, fastening			O.K.	Damaged or not all complete	New reflectors
Drive/gear shift							
Chain/cassette/pinion/chainring	6 months	Check for damage			O.K.	Damage	Refasten if necessary or replace as specified in parts list
Chain guard/spoke guard	6 months	Check for damage			O.K.	Damage	Replace as specified in parts list
Bottom bracket axle/crank	6 months	Check mount fastening			O.K.	Loose	Retighten screws
Pedals	6 months	Check mount fastening			O.K.	Loose	Retighten screws
Shifter	6 months	Check mount fastening	Functional check		O.K.	Loose	Retighten screws
Shift cables	6 months	Check for damage	Functional check		O.K.	Loose and defective	Adjust shift cables; new shift cables if necessary
Front derailleur	6 months	Check for damage	Functional check		O.K.	Switching gears difficult or not possible	Adjust
Rear derailleur	6 months	Check for damage	Functional check		O.K.	Switching gears difficult or not possible	Adjust



Components	Frequency	Description			Criteria		Measures if rejected
		Inspection	Tests	Maintenance	Acceptance	Rejection	
Electric drive system							
On-board computer	6 months	Check for damage	Functional check		O.K.	No screen, defective screen display	Restart; test battery; new software or new on-board computer; remove from service,
Control panel	6 months	Control panel Check for damage	Functional check		O.K.	No response	Restart; contact control panel manufacturer, new control panel
Tachometer	6 months		Speed measurement		O.K.	Pedelec travelling 10% too fast/slow	Take pedelec out of service until the source of the error is found
Cabling	6 months	Visual inspection			O.K.	Failure in system, damage, kinked cables	New cabling
Battery mount	6 months	Firmly in position, lock, contacts	Functional check		O.K.	Loose; lock doesn't close, no contacts	New battery mount
Motor	6 months	Visual inspection and mount			O.K.	Damage, loose	Refasten motor, contact motor manufacturer, new motor; <i>take out of service</i>
Software	6 months	Check version			In latest version	Not latest version	Import update

Technical inspection, checking safety, test ride

Components	Description		Criteria		Measures if rejected
	Assembly/inspection	Tests	Acceptance	Rejection	
Brake system	6 months	Functional check	O.K.	No full braking; braking distance too long	Locate defective part in brake system and correct
Gear shift under operating load	6 months	Functional check	O.K.	Problems when shifting gear	Readjust gear shift
Suspension components (fork, shock absorber, seat post)	6 months	Functional check	O.K.	Suspension too deep or no longer exists	Locate defective component and correct
Electric drive	6 months	Functional check	O.K.	Loose connection, problems when riding, accelerate	Locate faulty component in electric drive and remedy
Lighting system	6 months	Functional check	O.K.	No continuous light, not bright enough	Locate defective part in lighting system and correct
Test ride	6 months	Functional check	No strange noises	Strange noises	Locate source of noise and correct

Date:	
Fitter's name:	
Final inspection by workshop manager:	



Notes

11.3 Parts list

11.3.1 E-Stream EVA 1 27.5"

22-18-1057

Fork	Bulls Lytro 34 BLACK LOR Air CTS Boost 1.8	Deflection: 120 mm
Damper
Steering headset	ACROS, AZX-262R1	...
Handlebars	Bulls	35 mm
Handles	#/BULLS	#
Stem	MTBi-Sport	with CCS slot
Saddle	#	BULLS Sportive Ergo
Seat post	Bulls #	...
Saddle clamp	MONKEYLINK, QR-ML2	...
Crank bearing	FSA	165 mm
Pedals	BULLS MTB	
Rear derailleur	SHIMANO, Deore RD-M5120-SGS Shadow Plus	10-speed derailleur gears
Shifter	SHIMANO, Deore SL-M4100	Shifter
Derailleur
Cassette/cassette sprocket	SHIMANO, Deore CS-M4100-10	11-42T
Chain	KMC, E10S	...
Belt
Brake, front/rear	SHIMANO, BR-MT420, BR-MT410	Hydraulic disc brake
Handbrake, front/rear	SHIMANO, BL-MT4100	...
Disc, front/rear	#	180 mm, centre lock
Wheel set
Rim, front/rear	RYDE, Disc 30	#
Hub, front	SHIMANO, HB-MT400	Cassette hub for disc brake
Hub, rear	SHIMANO, FH-MT400	Cassette hub
Spokes	#	#
Tyres	SCHWALBE, Smart Sam K-Guard	65-584, 27.5 × 2.60
Tube	#	#
Headlight	#	#
Rear light	#	#
Dynamo
Pannier rack	#	#
Guard	#	#
Chain guard
Lock	ABUS	#

Stand/stand mount	#	#
Motor	BROSE, S-Mag Plus FIT	250 Watt, 85 Nm
Rechargeable battery	BMZ, UltraCore 555	555 Wh
Display	FIT, LCD Remote	...
Charger	FIT	4 A

...not available

Not yet available when the instructions were produced

11.3.2 E-Stream EVA TR1 27.5"

22-18-1060

Fork	Bulls, Lytro 34 LOR Air 1.8 CTS Boost	Deflection: 120 mm
Damper	SR SUNTOUR	Unair LOR8
Steering headset	ACROS, AZX-262R1	...
Handlebars	BULLS	35 mm
Handles	#/BULLS	#
Stem	MTBi-Sport	with CCS slot
Saddle	#	BULLS Sportive Ergo
Seat post	Bulls #	...
Saddle clamp	MONKEYLINK, ML-CC	...
Crank bearing	FSA	165 mm
Pedals	BULLS MTB	...
Rear derailleur	SHIMANO, Deore RD-M5120-SGS Shadow Plus	10-speed derailleur gears
Shifter	SHIMANO, Deore SL-M4100	Shifter
Derailleur
Cassette/cassette sprocket	SHIMANO, Deore CS-M4100-10	11-42T
Chain	KMC, E10S	...
Belt
Brake, front/rear	SHIMANO, BR-MT420, BR-MT410	Hydraulic disc brake
Handbrake, front/rear	SHIMANO, BL-MT4100	...
Disc, front/rear	#	180 mm, centre lock
Wheel set
Rim, front/rear	RYDE, Disc 30	#
Hub, front	SHIMANO, HB-MT400	Cassette hub for disc brake
Hub, rear	SHIMANO, FH-MT400	Cassette hub
Spokes	#	#
Tyres	SCHWALBE, Nobby Nic Performance	65-584, 27.5 × 2.60
Tube	#	#
Headlight	#	#
Rear light	#	#
Dynamo
Pannier rack	#	#
Guard	#	#
Chain guard
Lock	ABUS	#
Stand/stand mount	#	#
Motor	BROSE, S-Mag Plus FIT	250 Watt, 85 Nm

Rechargeable battery	BMZ, UltraCore 555	555 Wh
Display	FIT, LCD Remote	...
Charger	FIT	4 A

...not available

Not yet available when the instructions were produced

11.3.3 E-Stream EVA TR2 27.5"

22-18-1061

Fork	Bulls Lytro 34 LOR Air 1.8 CTS Boost	Deflection: 120 mm
Damper	SR SUNTOUR	Unair LOR8
Steering headset	ACROS, AZX-262R1	...
Handlebars	BULLS	35 mm
Handles	#/BULLS	#
Stem	MTBi-Sport	with CCS slot
Saddle	#	BULLS Sportive Ergo
Seat post	Bulls #	...
Saddle clamp	MONKEYLINK, ML-CC	...
Crank bearing	FSA	165 mm
Pedals	BULLS MTB	...
Rear derailleur	SHIMANO, Deore RD-M5120-SGS Shadow Plus	12-speed derailleur gears
Shifter	SHIMANO, Deore RD-M5120-SGS Shadow Plus	Shifter
Derailleur
Cassette/cassette sprocket	SHIMANO, Deore CS-M4100-10	11-42T
Chain	KMC, E10S	...
Belt
Brake, front/rear	SHIMANO, BR-MT420/BR-MT410	Hydraulic disc brake
Handbrake, front/rear	SHIMANO, BL-MT4100	...
Disc, front/rear	#	180 mm, centre lock
Wheel set
Rim, front/rear	RYDE, Disc 30	#
Hub, front	SHIMANO, HB-MT400	Cassette hub for disc brake
Hub, rear	SHIMANO, FH-MT400	Cassette hub
Spokes	#	#
Tyres	SCHWALBE, Nobby Nic Performance	65-584, 27.5 × 2.60
Tube	#	#
Headlight	#	#
Rear light	#	#
Dynamo
Pannier rack	#	#
Guard	#	#
Chain guard
Lock	ABUS	#
Stand/stand mount	#	#
Motor	BROSE, S-Mag Plus FIT	250 Watt, 85 Nm

Rechargeable battery	BMZ, UltraCore 555	555 Wh
Display	FIT, LCD Remote	...
Charger	FIT	4 A

...not available

Not yet available when the instructions were produced

11.3.4 E-Stream EVO 1 29"

22-18-2007, 22-18-1056

Fork	Bulls, Lytro 34 BLACK LOR Air CTS Boost 1.8	Aluminium
Damper
Steering headset	ACROS, AZX-262R1	...
Handlebars	Bulls	35 mm
Handles	#/BULLS	#
Stem	MTBi-Sport	with CCS slot
Saddle	#	BULLS Sportive Ergo
Seat post	Bulls #	...
Saddle clamp	MONKEYLINK, ML-CC	...
Crank bearing	FSA	165 mm
Pedals	BULLS MTB	
Rear derailleur	SHIMANO, Deore RD-M5120-SGS Shadow Plus	10-speed derailleur gears
Shifter	SHIMANO, Deore SL-M4100	Shifter
Derailleur
Cassette/cassette sprocket	SHIMANO, Deore CS-M4100-10	11-42T
Chain	KMC, E10S	...
Belt
Brake, front/rear	SHIMANO, BR-MT420/BR-MT410	Hydraulic disc brake
Handbrake, front/rear	SHIMANO, BL-MT4100	...
Disc, front/rear	#	180 mm, centre lock
Wheel set
Rim, front/rear	RYDE, Disc 30	#
Hub, front	SHIMANO, HB-MT400	Cassette hub for disc brake
Hub, rear	SHIMANO, FH-MT400	Cassette hub
Spokes	#	#
Tyres	SCHWALBE, Smart Sam K-Guard	65-622, 29 × 2.60
Tube	#	#
Headlight	#	#
Rear light	#	#
Dynamo
Pannier rack	#	#
Guard	#	#
Chain guard
Lock	ABUS	#
Stand/stand mount	#	#
Motor	BROSE, S-Mag Plus FIT	250 Watt, 85 Nm

Rechargeable battery	BMZ, UltraCore 555	555 Wh
Display	FIT, LCD Remote	...
Charger	FIT	4 A

...not available

Not yet available when the instructions were produced

11.3.5 E-Stream EVO 2 Street 27.5"

22-18-1058

Fork	Bulls, Lytro 35 SL Supreme LOR Air 1.8 CTS Boost	Deflection: 120 mm
Damper
Steering headset	ACROS, AZX-262R1	...
Handlebars	ZECURE, MTB	...
Handles	#/BULLS	#
Stem	MTBi-Sport	with CCS slot
Saddle	#	BULLS Sportive Ergo
Seat post	Bulls #	...
Saddle clamp	MONKEYLINK, ML-CC	...
Crank bearing	FSA	165 mm
Pedals	ZECURE, MTB	...
Rear derailleur	SHIMANO, Deore RD-M6100-SGS Shadow Plus	12-speed derailleur gears
Shifter	SHIMANO, Deore XT SL-M610-I	Shifter
Derailleur
Cassette/cassette sprocket	SHIMANO, Deore CS-M6100 -12	10-51T
Chain	SHIMANO, CN-M6100	...
Belt
Brake, front/rear	SHIMANO, BR-MT420, BR-MT410	Hydraulic disc brake
Handbrake, front/rear	SHIMANO, BL-MT4100	...
Disc, front/rear	#	203 mm, centre lock
Wheel set
Rim, front/rear	RYDE, Disc 30	#
Hub, front	SHIMANO, HB-MT400	Cassette hub for disc brake
Hub, rear	SHIMANO, FH-MT410	Cassette hub
Spokes	#	#
Tyres	SCHWALBE, Smart Sam K-Guard	57-584, 27.5 × 2.25
Tube	#	#
Headlight	FUXON, FF-100 EB	100 lux
Rear light	FUXON, R-Glow	.
Dynamo
Pannier rack	MONKEYLOAD	MonkeyLoad system carrier
Guard	#	Aluminium
Chain guard
Lock	ABUS	#
Stand/stand mount	PLETSCHER, Comp Flex 40	...
Motor	BROSE, S-Mag Plus FIT	250 Watt, 85 Nm

Rechargeable battery	BMZ, UltraCore 555	555 Wh
Display	FIT, LCD Remote	...
Charger	FIT	4 A

...not available

Not yet available when the instructions were produced

11.3.6 E-Stream EVO AM 2 29"

22-18-1005

Fork	Bulls, Lytro 35 SL Supreme LOR Air 1.8 CTS Boost with sportive mini fender	Aluminium
Damper	SR SUNTOUR, Unair LOR8	
Steering headset	ACROS, AZX-262R1	...
Handlebars	Bulls	35 mm
Handles	#/BULLS	#
Stem	BULLS The Frog	...
Saddle	#	BULLS Sportive Ergo
Seat post	Limotec, A1	...
Saddle clamp	MONKEYLINK, ML-CC	...
Crank bearing	FSA	165 mm
Pedals	ZECURE, MTB	MTB
Rear derailleur	SHIMANO, Deore RD-M6100-SGS Shadow Plus	12-speed derailleur gears
Shifter	SHIMANO, Deore XT SL-M610-I	...
Derailleur
Cassette/cassette sprocket	SHIMANO, Deore CS-M6100 -12	10-51T
Chain	SHIMANO, CN-M6100	...
Belt
Brake, front/rear	SHIMANO, BR-MT420/BR-MT410	Hydraulic disc brake
Handbrake, front/rear	SHIMANO, BL-MT4100	...
Disc, front/rear	#	203 mm/180 mm, centre lock
Wheel set
Rim, front/rear	RYDE, Disc 30	#
Hub, front	SHIMANO, HB-MT400	Cassette hub for disc brake
Hub, rear	SHIMANO, FH-MT410	Cassette hub
Spokes	#	#
Tyres	SCHWALBE, Nobby Nic Performance	65-622, 29 × 2.60
Tube	#	#
Headlight	#	#
Rear light	#	#
Dynamo
Pannier rack	#	#
Guard	#	#
Chain guard
Lock	ABUS	#
Stand/stand mount	#	#

Motor	BROSE, S-Mag Plus FIT	250 Watt, 85 Nm
Rechargeable battery	BMZ, UltraCore 555	555 Wh
Display	FIT, LCD Remote	...
Charger	FIT	4 A

...not available

Not yet available when the instructions were produced

11.3.7 E-Stream EVO AM 3 29"

22-18-1004

Fork	ROCKSHOX, 35 Gold RL 1.8 tapered with mini sportive fender	Aluminium
Damper	ROCKSHOX, RT Select+	...
Steering headset	ACROS, AZX-262R1	...
Handlebars	Bulls	35 mm
Handles	#/BULLS	#
Stem	BULLS The Frog	...
Saddle	SELLE ROYAL	Vivo Ergo
Seat post	Limotec, A1	...
Saddle clamp	MONKEYLINK, ML-CC	...
Crank bearing	FSA	#
Pedals	ZECURE, MTB	
Rear derailleur	SHIMANO, Deore XT RD-M8100-SGS Shadow Plus	12-speed derailleur gears
Shifter	SHIMANO, SLX SL-M7100-IR I	...
Derailleur
Cassette/cassette sprocket	SHIMANO, SLX CS-M7100-12	10-51T
Chain	SHIMANO, CN-M7100	...
Belt
Brake, front/rear	SHIMANO, SLX BR-M7120	Hydraulic disc brake
Handbrake, front/rear	SHIMANO, BL-M7100	...
Disc, front/rear	#	203 mm, centre lock
Wheel set
Rim, front/rear	RYDE, Disc 30	#
Hub, front	SHIMANO, HB-MT400	Cassette hub for disc brake
Hub, rear	SHIMANO, FH-MT410	Cassette hub
Spokes	#	#
Tyres	MAXXIS, DHF, AM, EN/ Minion DHR II, AM, EN	29× 2.60
Tube	#	#
Headlight	#	#
Rear light	#	#
Dynamo
Pannier rack	#	#
Guard	#	#
Chain guard
Lock	ABUS	#
Stand/stand mount	#	#

Motor	BROSE, S-Mag Plus FIT	250 Watt, 85 Nm
Rechargeable battery	BMZ, UltraCore 555	555 Wh
Display	FIT, LCD Remote	...
Charger	FIT	4 A

...not available

Not yet available when the instructions were produced

11.3.8 E-Stream EVO AM 4 29"

22-18-1001

Fork	FOX, 36 Rhythm Float Boost with sportive mini fender	Deflection: 150 mm
Damper	FOX, Float DPS Performance	...
Steering headset	ACROS, AZX-262R1	...
Handlebars	Bulls	35 mm
Handles	#	#
Stem	BULLS The Frog	...
Saddle	SELLE ROYAL	Vivo Ergo
Seat post	Limotec, A1	...
Saddle clamp	MONKEYLINK, ML-CC	...
Crank bearing	FSA	165 mm
Pedals	ZECURE, MTB	
Rear derailleur	SHIMANO, Deore XT RD-M8100-SGS Shadow Plus	12-speed derailleur gears
Shifter	SHIMANO, Deore XT SL-M8100 I	...
Derailleur
Cassette/cassette sprocket	SHIMANO, SLX CS-M7100-12	10-51T
Chain	SHIMANO, CN-M7100	...
Belt
Brake, front/rear	SHIMANO, Deore XT BR-M8100	Hydraulic disc brake
Handbrake, front/rear	SHIMANO, BL-M8100	...
Disc, front/rear	#	203 mm, centre lock
Wheel set
Rim, front/rear	RYDE, Disc 30	#
Hub, front	SHIMANO, HB-MT400	Cassette hub for disc brake
Hub, rear	SHIMANO, FH-MT410	Cassette hub
Spokes	#	#
Tyres	MAXXIS, DHF, AM, EN/ Minion DHR II, AM, EN	29× 2.60
Tube	#	#
Headlight	#	#
Rear light	#	#
Dynamo
Pannier rack	#	#
Guard	#	#
Chain guard
Lock	ABUS	#
Stand/stand mount	#	#
Motor	BROSE, S- Mag Pro FIT	250 Watt, 90 Nm

Rechargeable battery	BMZ, UltraCore 555	555 Wh
Display	FIT, LCD Remote	...
Charger	FIT	4 A

...not available

Not yet available when the instructions were produced

11.3.9 Lacuba EVO Cross

22-15-1033, 22-15-1034

Fork	SR SUNTOUR, XCM 32 ATB Coil	Deflection: 80 mm
Damper
Steering headset	FSA, no.57 SC	...
Handlebars	ZECURE	
Handles	#	Plastic
Stem	FUXON, AS-SUVI	with CCS slot
Saddle	ZECURE	MTB
Seat post	#	#
Saddle clamp	#	Aluminium
Crank bearing	FSA	170 mm
Pedals	WELLGO, C-211	with sandpaper
Rear derailleur	SHIMANO, Deore RD-M5120	10-speed derailleur gears
Shifter	SHIMANO, Deore SL-M4100	Deore SL-M4100
Derailleur
Cassette/cassette sprocket	SHIMANO,	11-42T
Chain	KMC, E10S	...
Belt
Brake, front/rear	SHIMANO, BR-MT200	Hydraulic disc brake
Handbrake, front/rear	SHIMANO, BL-MT201	DUAL CONTROL lever
Disc, front/rear	#	180 mm, centre lock
Wheel set
Rim, front/rear	RYDE, Taurus 2000	#
Hub, front	FORMULA, DC-20FQR	Aluminium, 6-BOLT TYPE, 14G × 24H
Hub, rear	FORMULA, DC-22RQR	Aluminium, 6-BOLT TYPE, 13Gx32H
Spokes	#	#
Tyres	SCHWALBE, G-One Allround	57-622, 29 × 2.25
Tube	#	#
Headlight	FUXON, FS-50 EB	50 lux
Rear light	FUXON, RL-Mini	...
Dynamo
Pannier rack	#	#
Guard	SKS, Velo MTB 65	...
Chain guard	HORN, Catena 17	...
Lock	ABUS	#
Stand/stand mount	PLETSCHER, Comp 40	...
Motor	BROSE, S-Mag Eco Fit	...

Rechargeable battery	BMZ, UltraCore 555	555 Wh
Display	FIT, LCD Remote	...
Charger	FIT	4 A

...not available

Not yet available when the instructions were produced

12 Glossary

Bicycle for young adults

Source: ISO 4210-2: pedelec designed for use on public roads by a young adult whose weight is less than 40 kg, with maximum saddle height of 635 mm or more and less than 750 mm. (see ISO 4210).

Brake lever

Source: EN 15194:2017: lever used to apply the brake.

Braking distance

Source: EN 15194:2017: distance travelled by a pedelec between the commencement of braking and the point at which the pedelec comes to rest.

Cargo bike

Source: DIN 79010: pedelec mainly designed to carry goods.

CE marking

Source: Directive on Machinery: the manufacturer uses the CE marking to declare that the pedelec complies with the applicable requirements.

City and trekking bicycles

Source: EN-ISO 4210 - 2: pedelec designed for use on public roads primarily for means of transportation or leisure.

Consumables

Source: EN 82079-1: any part or material that is needed to continue using or maintain the product.

Continuous power rating

Source: ISO 15194:2017, output power specified by the manufacturer at which the motor reaches its thermal equilibrium under the specified ambient conditions.

Decommissioning

Source: DIN 31051: intentional, unlimited interruption in an object's functional capability.

Disc brake

Source: EN 15194:2017: brake in which brake pads are used to grip the lateral faces of a thin disc attached to or incorporated into the wheel hub.

Drive belt

Source: EN 15194:2017: seamless ring belt which is used as a means of transmitting drive force.

Electrical control system

Source: EN 15194:2017: electronic and/or electrical component or an assembly of components provided for installation into a vehicle, together with all electrical connections and associated wiring for the motor electrical power assistance.

Electrically power assisted cycle, bicycle

Source: EN 15194:2017: electrically power assisted cycle pedelec EPAC bicycles, equipped with pedals and an auxiliary electric motor, which cannot be propelled exclusively by means of the auxiliary electric motor, except in start-up assistance mode.

Emergency stop

Source: ISO 13850:2015, function or signal, designed: — to avert arising or reduce existing hazards to persons, damage to machinery or to work in progress; – to be initiated by a single human action.

Fault

Source: EN 13306:2018-02, 6.1: state of an item (4.2.1) characterized by its inability to perform a required function (4.5.1), excluding such inability during preventive maintenance or other scheduled actions or due to lack of external resources.

Folding bicycle

Source: ISO 4210-2: pedelec designed to fold into a compact form, making it easy to transport and store.

Fork steerer

Source: EN 15194:2017: part of a fork that rotates around the steering axis of a pedelec frame head tube. It is normally connected to the fork crown or directly to the fork legs, and is normally the point of connection between the fork and the handlebar stem.

Fracture

Source: EN 15194:2017: unintentional separation into two or more parts.

Maintenance

Source: DIN 31051: maintenance is generally performed at regular intervals and often carried out by trained technical staff. This ensures a maximum service life and low wear and tear for the maintained items. Proper maintenance is often also a pre-requisite for providing a warranty.

Manufacturer

Source: Directive 2006/42/EC on Machinery, 17.05.2006 Any natural or legal person who designs and/or manufactures machinery or partly completed machinery covered by this Directive and is responsible for the conformity of the machinery or the partly completed machinery with this Directive with a view to its being placed on the market, under his own name or trademark or for his own use.

Maximum continuous power rating

Source: ZEG: the maximum continuous power rating is the maximum power for the electric motor output shaft during 30 minutes.

Maximum permitted total weight

Source: EN 15194:2017: weight of the fully assembled pedelec plus the rider and baggage, as specified by the manufacturer.

Maximum saddle height

Source: EN 15194:2017: vertical distance from the ground to the point where the top of the seat surface is intersected by the seat-post axis, measured with the saddle in a horizontal position and with the seat-post set to the minimum insertion-depth mark.

Maximum tyre pressure

Source: EN 15194:2017: maximum tyre pressure recommended by the tyre or rim manufacturer for a safe and efficient performance. If the rim and tyre both indicate a maximum tyre pressure, the maximum inflation pressure is the lower of the two pressures indicated.

Minimum insertion depth

Source: EN 15194:2017: mark indicating the minimum insertion depth of handlebar stem into fork steerer (fork stem) or seat post into frame.

Model year

Source: ZEG: the model year refers to the first production year that the series-manufactured pedelec was manufactured in the version in question and is not always identical with the year of manufacture. The year of manufacture may be before the model year in some cases. If no technical modifications are introduced to the series, production may continue of pedelecs from a previous model year.

Mountain bike, MTB

Source: ISO 4210 - 2: pedelec designed for use off-road on rough terrain, on public roads, and on public pathways, equipped with a suitably strengthened frame and other components, and, typically, with wide-section tyres with coarse tread patterns and a wide range of transmission gears.

Negative deflection

Negative deflection or sag is fork compression caused by body weight and gear (e.g. a backpack), the rider's position and the frame geometry.

Off-road rough terrain

Source: EN 15194:2017: rough gravel tracks, forest trails and other generally off-road tracks where tree roots and rocks are likely to be encountered.

Operating instructions

Source: ISO/DIS 20607:2018: part of the user information that machine manufacturers provide to machine operators; it contains guidance, instructions and tips related to the use of the machine in all its life cycle phases.

Placing on the market

Source: Directive 2006/42/EC on Machinery, 17.05.2006, Making available for the first time in the Community machinery or partly completed machinery with a view to distribution or use, whether for reward or free of charge.

Pressure point

Source: ZEG: the pressure point on a brake is the point on the brake lever where the brake disc and brake pads respond and the braking process is initiated.

Quick-release device, quick release

Source: EN 15194:2017: lever actuated mechanism that connects, retains or secures a wheel or any other component.

Racing bicycle

Source: ISO 4210-2: bicycle intended for high-speed amateur use on public roads and having a steering assembly with multiple grip positions (allowing for an aerodynamic posture), a multi-speed transmission system, tyre width not greater than 28 mm and a maximum mass of 12 kg for the fully assembled bicycle.

Rebound

The rebound defines the speed at which the fork rebounds after being loaded.

Rechargeable battery, battery

Source: DIN 40729:1985-05: a rechargeable battery is an energy storage device that can store supplied electrical energy as chemical energy (charging) and release it as electrical energy when required (discharging).

Seat post

Source: EN 15194:2017: component that clamps the saddle (with a bolt or assembly) and connects it to the frame.

Shut-off speed

Source: EN 15194:2017: speed reached, by the pedelec, at the moment the current has dropped to zero or to the no load current value.

Slippage

Source: DIN 75204-1:1992-05: the difference in relation to vehicle speed between the vehicle speed and the speed of its wheels at their circumference.

Spare part

Source: EN 13306:2018-02, 3.5: item intended to replace a corresponding item in order to retain or maintain the original required function of the item.

Suspension fork

Source: EN 15194:2017: front fork incorporating controlled, axial flexibility to reduce the transmission of road-shocks to the rider.

Suspension frame

Source: EN 15194:2017: frame incorporating controlled, vertical flexibility to reduce the transmission of road-shocks to the rider.

Total deflection

Source: Benny Wilbers, Werner Koch: Neue Fahrwerkstechnik im Detail (New chassis technology in detail): the distance that the wheel travels between an unloaded and a loaded position is called total deflection. When at rest, the vehicle's mass is applied to the springs and reduces the total deflection by the *negative deflection* to the positive deflection.

Wear

Source: DIN 31051: reduction in useful life (4.3.4), caused by chemical and/or physical processes.

Weight of the ready-to-ride pedelec

Source: ZEG: the indicated weight for a ready-to-ride pedelec refers to the weight of a pedelec at the time of sale. The weight of each additional accessory must be added to this weight

Wheel

Source: ISO 4210 - 2: unit or combination of hub, rim and spokes or disc, but excluding tyre assembly.

Work environment

Source: ISO 9000:2015: set of conditions under which work is performed.

Year of manufacture

Source: ZEG: the year of manufacture is the year in which the pedelec was manufactured. The production period is always from May to July the following year.

12.1 Abbreviations

Abbreviation	Meaning/derivation
ABS	Anti-blocking system
EPAC	Electric power assisted cycle
PTW	permitted total weight

Table 73: Table of abbreviations

12.2 Simplified terms

The following terms are used for better legibility:

Term	Meaning
Operating instructions	Original operating instructions
Damper	Rear frame damper
Specialist dealer	Bicycle specialist dealer
Motor	Drive motor, sub-system
Belt drive	Toothed belt drive

Table 74: Table of simplified terms

13 Appendix

I. Translation of the original EC/EU Declaration of Conformity

Manufacturer

ZEG Zweirad-Einkaufs-Genossenschaft eG
Longericher Str. 2
50739 Köln, Germany

Authorised representative for documentation*

Janine Otto
c/o ZEG Zweirad-Einkaufs-Genossenschaft eG
Longericher Str. 2
50739 Köln, Germany

The machine, pedelec types:

22-18-1057	E-Stream EVA 1 27.5	Mountain bike
22-18-1060	E-Stream EVA TR1 27.5"	Mountain bike
22-18-1061	E-Stream EVA TR2 27.5"	Mountain bike
22-18-1056	E-Stream EVO 1 29"	Mountain bike
22-18-2007	E-Stream EVO 1 29"	Mountain bike
22-18-1058	E-Stream EVO 2 Street 27.5"	Mountain bike
22-18-1005	E-Stream EVO AM 2 29"	Mountain bike
22-18-1004	E-Stream EVO AM 3 29"	Mountain bike
22-18-1001	E-Stream EVO AM 4 29"	Mountain bike
22-18-1005	E-Stream EVO TR1 27.5"	Mountain bike
22-15-1033	Lacuba EVO Cross	Mountain bike
22-15-1034	Lacuba EVO Cross	Mountain bike

Year of manufacture 2021 and year of manufacture 2022, complies with the following applicable EU provisions:

- Machinery Directive 2006/42/EC**
- RoHS Directive 2011/65/EU
- Electromagnetic Compatibility Directive 2014/30/EU.

The safety objectives in the Low Voltage Directive 2014/35/EU have been met in compliance with Appendix I, No. 1.5.1 of the Machinery Directive 2006/42/EC.

The following harmonised standards have been applied:

- ISO 20607:2018 Safety machinery – Instruction handbook – General drafting principles
- EN 15194:2017, Cycles – Electrically power assisted cycles – EPAC Bicycles

The following other technical standards have been applied:

- EN 11243:2016: Cycles – Pannier racks for bicycles – Requirements and test methods



Cologne, 19.02.2022

Egbert Hageböck, Chairman, ZEG Zweirad-Einkaufs-Genossenschaft eG

* Community member who is authorised to compile the technical documentation

**The chain or belt guard does comply with EN 15194:2017. The design used was tested during the risk analysis.

II. Declaration of conformity for incomplete machine



EU Konformitätserklärung EU Declaration of Conformity EU Déclaration de Conformité

Firma | Company | Entreprise

Biketec GmbH

Adresse | Address | Adresse

Luzernstrasse 84 | CH – 4950 Huttwil

Wir erklären in alleiniger Verantwortung, dass das Produkt:
We declare under our sole responsibility, that the product:
Nous déclarons sous notre responsabilité, que le produit:

Produkt Product	Typ Type	Teile Nr. Part No.
GX Force Eco FIT GX Force Eco FIT	NUA233F	500041
GX Force Pro FIT GX Force Pro FIT	NUA233F	500041 & Upgrade 501058
GX Ultimate Eco FIT GX Ultimate Eco FIT	NUA230F	500042
GX Ultimate Pro FIT GX Ultimate Pro FIT	NUA230F	500042 & Upgrade 501059
GX Force Eco Coaster FIT GX Force Eco Coaster FIT	NUA234F	500078
GX Force Pro Coaster FIT GX Force Pro Coaster FIT	NUA234F	500078 & Upgrade 501058

mit den Anforderungen der Richtlinien:
fulfills the requirements of the directives:
avec les exigences des directives:

2006/42/EU

und den Anforderungen der harmonisierten Normen:
and fulfills the requirements of the harmonised standards:
et les exigences des normes harmonisées:

EN 15194 :2017 ;
DIN EN ISO 13849-2016

und den herangezogenen Prüfberichten übereinstimmt und damit den Bestimmungen entspricht.
and the taken test reports and therefore corresponds to the regulations of the directives.
et les rapports d'essais notifiées et, ainsi, correspond aux règlement de la Directive.

Biketec GmbH | Luzernstrasse 84 | CH-4950 Huttwil | T +41 62 959 53 00 | info@fit-ebike.ch | www.fit-ebike.com



Es ist wie folgt gekennzeichnet:
It is marked as follows:
Il est marqué comme suit:



Huttwil, 13.08.2021

Ort und Datum der Ausstellung
Place and date of issue
Lieu et date d'établissement

A handwritten signature in black ink, appearing to be "Ivica Durdevic".

Ivica Durdevic, CEO

Name und Unterschrift des Befugten
Name and signature of authorized person
Nom et signature de la personne autorisée

III. Directive declaration of conformity with RED Directive

Biketec GmbH, Luzernstrasse 84, 4950 Huttwil, Switzerland, hereby declares that the Remote Basic FIT 2.0 radio system type complies with Directive 2014/53/EU. The complete EU declaration of conformity is available online at:

[https://tessa.zegxx-web51.eimed-server.de/ui/index.php?bereich=ui&modul_id=104&kategorie=bezug_erstellen&com=erstellen&vorlage=plain&bezug_typ=portal&bezug_schluesel=2c4bdb985ad763d87b4ea6cbb142c515&bezug_datei_name=2031-08-30_4a9b18d550710bc5416e4427eea76933&sprache=.](https://tessa.zegxx-web51.eimed-server.de/ui/index.php?bereich=ui&modul_id=104&kategorie=bezug_erstellen&com=erstellen&vorlage=plain&bezug_typ=portal&bezug_schluesel=2c4bdb985ad763d87b4ea6cbb142c515&bezug_datei_name=2031-08-30_4a9b18d550710bc5416e4427eea76933&sprache=)

IV. REACH declaration of conformity



Lieferantenselbsterklärung Supplier declaration Autodéclaration du fournisseur

Gemäss Artikel 33 | according to article 33 | Selon l'article 33

Der Verordnung der Europäischen Gemeinschaft (EG) 1907/2006
of European Community Regulation (EC) 1907/2006
Le règlement de la Communauté européenne (CE) 1907/2006

REACH

Registrierung, Bewertung und Zulassung von Chemikalien
Registration, Evaluation, Autorisation of Chemicals
Enregistrement, évaluation, autorisation et restriction des substances chimiques

Biketec GmbH garantiert hiermit, dass die ausgelieferten Produkte der REACH Verordnung (EG) Nr. 1907/2006 des Europäischen Parlaments und des Rates vom 18. Dezember 2006 entsprechen. Die maximalen Konzentrationswerte der Stoffe, die auf der Kandidatenliste der besonders besorgniserregenden Stoffe (SVHC) für die Zulassung von der Europäischen Chemikalienagentur (ECHA) die bis zum heutigen Tag (20.04.2021) veröffentlicht wurde, werden nicht überschritten.

Biketec GmbH hereby guarantees that the delivered products comply with the REACH Regulation (EC) No 1907/2006 of the European Parliament and of the Council of 18 December 2006. The maximum concentration values of the substances published on the candidate list of substances of very high concern (SVHC) for authorisation by the European Chemicals Agency (ECHA) until today (20.04.2021) are not exceeded.

Biketec GmbH garantit par la présente que les produits livrés sont conformes au règlement REACH (CE) n° 1907/2006 du Parlement européen et du Conseil du 18 décembre 2006. Les valeurs de concentration maximales des substances figurant sur la liste des substances extrêmement préoccupantes (SVHC) candidates à l'autorisation publiée par l'Agence européenne des produits chimiques (ECHA) jusqu'à aujourd'hui (20.04.2021) ne sont pas dépassées.

Die aktuelle Tabelle der SVHC Stoffe kann hier eingesehen werden.

The current table of SVHC substances can be viewed here.

Le tableau actuel des substances SVHC peut être consulté ici.

<https://echa.europa.eu/candidate-list-table>

Huttwil, 20.04.2021
Ort und Datum der Ausstellung

Biketec GmbH | Luzernstrasse 84 | CH-4950 Huttwil | T +41 62 959 53 00 | info@fit-ebike.ch | www.fit-ebike.com

14 Keyword index

A

- Air valve, 35
 - position, 35, 49
- Altimeter,
 - calibrate, 141
- Articulated shaft,
 - care for 178
- Assistance system,
 - adjust 141
- Auto switch-off,
 - adjust, 141
- Axle, 35
 - position, 35
 - torque, 73

B

- Backlight,
 - adjust, 141
- Back-pedal brake,
 - brake, 156
 - check 186
- Ball bearings,
 - position, 40
- Basic cleaning 171
- Battery,
 - charge, 152
 - check, 84, 91
 - clean, 171
 - dispose, 250
 - insert, 151
 - read battery level 54
 - remove, 151
 - ship, 81
 - store, 82
 - transport, 81
 - position, 29
 - technical data, 67
 - torques, 77
- Battery, see rechargeable battery
- Bead core, 38
 - position, 36
- Bell,
 - check 169
 - use 149
- Belt guard 20
- Belt sprocket, 45
- Belt, 45
 - check belt for wear 190
 - check tension 190
 - clean, 174
 - Gates Carbon Drive mobile app 191

- Bicycle for young adults, 276
- Bike headset, see steering headset
- Bluetooth,
 - display connected devices, 60
 - malfunctions, 18
- Bowden cable, 41
 - check, 184
- Brake cable, 41
 - torque, 75
- Brake calliper, 42
 - position, 42
 - torque, 75
- Brake disc, 42
 - check, 185
 - clean 174
 - replace, 248
 - position, 42
- Brake lever, 42
 - clean 174
 - service, 179
 - position, 49
- Brake linings, 42
 - check, 185
 - replace, 129, 248
 - retract, 129
 - position, 42
 - torque, 75
- Brake, 41
 - check 169
 - check brake disc, 185
 - check brake linings, 185
 - check pressure point, 184
 - check, 184
 - clean, 170
 - secure during transport, 80
 - cable clip, 41
 - cover cap, 41
 - hydraulic, 41
 - insert pin, 41
 - knob, 41
 - mechanical, 41
 - union nut, 41
- Brake,- use, 156
- Brakes,-
 - replace, 129
- Braking distance, 276
- Break in operation, 82
 - carry out, 82
 - prepare, 82
- Button
 - Light, 50

- Button,
 - On-Off (on-board computer), 50
 - Push Assist 50
 - Selector button, 50
- Buttons,
 - On-Off (battery), 65

C

- Cantilever brake,
 - torque, 76
- Carbon seat post,
 - care for, 177
- Carbon suspension fork,
 - inspect, 212
- Carcass, 37
 - position, 36
- Cargo bike, 276
- Cassette,
 - clean 173
- CE marking, 276
- Chain guard 20
- Chain guard,
 - clean, 174
 - position, 29
 - torques 77
- Chain wheel, 45
- Chain wheels,
 - clean 173
- Chain, 45
 - care for 178
 - check 188
 - check for wear 188
 - check tension 188
 - clean, 174
 - replace, 248
 - service, 216
 - tension, 248
 - position, 29, 45
- Chainring brake,
 - torque, 76
- Charge mode,
 - adjust, 142
- Charger, 47
 - dispose, 250
 - store, 82
- Chassis, 30
- Child seat, 143
- City and trekking bicycles, 276
- Clamping force,
 - adjust quick release 87
 - check quick release, 87

- Clock, 53
 - adjust, 140
 - set, 60
- Compression damper, 35
 position, 35
- Compression damping, 34
- Consumables, 276
- Continuous power rating 276
- Control panel,
 - clean, 171
- Conventional valve, see Dunlop valve
- Crank bearing/crank set,
 torque, 76
- Crown, 35
 position, 35
- D**
- Decommissioning, 276
- Derailleur gears,
 - check 194
 - use, 159
- Dimensions, 79
- Disc brake, 276
 torque, 75
- Drive belt, 276
- Drive system, 45, 46
 - switch off, 153
 - switch on, 153
- Dual pivot rim brake,
 torque, 75
- Dunlop valve, see conventional valve
- Dust seal, 35
 position, 35
- E**
- Electrical control system, 276
- Emergency stop 276
- Emergency stop system 21
- Error message, 60, 97
 - display 142
- F**
- Factory settings,
 - reset, 59, 142
- Fault, 276
- Folding bicycle, 276
- Fork end, 31, 35
 position, 31, 35
- Fork leg,
 position, 31
- Fork lock, 64
- Fork steerer, 31, 35, 277
 position, 31, 35
- Fork, 31
 - care for, 170, 175
 - check 168
 - clean, 172
 position, 29
 rigid, 32
 SR SUNTOUR structure, 35
 suspended, 278
 suspension fork, 32
- Fracture, 277
- Frame number,
 position, 29
- Frame, 30
 - care for, 170
 - check 168
 - clean, 172
 - inspect for, 209
 position, 29
 suspended, 278
- Frame,- care for, 175
- Freewheel,
 torque, 73
- French valve, see Presta valve
- Front derailleur,
 - clean, 173
 torque, 73
- Front wheel brake,
 - brake, 156
- Front wheel, see Wheel
- G**
- Gear hub,
 - inspect, 210
- Gear shift,
 - adjust Bowden-cable-
 operated twist grip, dual-
 cable 197
 - check 195
 - check electric gear shift,
 195
 - use, 159
- Guards,
 - check 168
- H**
- Handbrake, 276
 position, 49
 torque, 74
- Handlebars, 31
 - care for, 176
 - check 194
 - check, 93
 - clean, 172
 - use 150
 - use bar ends 150
 - use multi-position
 handlebars 150
 position, 29
 torque, 74
- Handles,
 - care for, 176
 - check 169
 - clean 172
 - use leather handles 150
 position, 49
- Headlight,
 - adjust, 137
 - check, 193
 - clean 170
 position, 29
 torque, 78
- Headlight, see front light
- Headset, see steering headset
- Heart rate sensor
 -connect, 141
- Hub axle,
 position, 40
- Hub body,
 position, 40
- Hub gear,
 - check 195
- Hub, 40
 - adjust ROHLOFF 196
 - care for 177
 - clean, 173
 position, 36
 torque, 72
 without additional features,
 40
- Hydraulic brake system,
 - check 184
- Hydraulic lockout 64
- I**
- Indicator
 Pulse, 57
- Indicator,
 battery level indicator, 52
 Cadence 57
 Clock 54
 Connection Status, 53
 Current Altitude, 56
 current speed, 52, 53
 dimmed headlight, 52
 level of assistance, 52
 light off 52
 main beam, 52
 Navi, 58
 range 52
 riding light symbol 52
 Total 56

- Trip Distance 54
- Trip Height, 55
- Trip Time, 55
- Tyre Pressure, 58
 - warning, 52
- Indicator, motor power, 52, 53
- Initial commissioning, 84
- Integrated battery,
 - insert, 151
- J**
- Jockey wheel,
 - care for 178
- K**
- Key,
 - Minus 50
 - Plus, 50
- Kickstand,
 - care for, 176
 - clean, 172
 - stability 197
 - position, 29
- Komoot app,
 - connect, 141
- L**
- Language,
 - set, 140
- Leather handles,
 - care for, 176
 - clean 172
- Leather saddle,
 - care for, 177
 - clean, 173
- Level of assistance, 52
 - select, 155
 - AUTO, 52
 - BOOST, 52
 - ECO, 52
 - HIGH, 52
 - OFF, 52
 - STD, 52
- LIMOTEC seat post,
 - fit 90
- Lock out,
 - position, 49
- Lockout, 64
- M**
- Maintenance, 277
- Manufacturer, 12, 277
- Mechanical,
 - gear shift 195
- Menu,
 - select, 51
- Minimum insertion depth
 - marking, 115
- Minimum insertion depth, 277
- Model year, 277
- Motor cover 20
- Motor cover,
 - torques, 77
- Motor, 46
 - clean, 171
 - position, 29
 - torques 77
- Mountain bike, 277
- Mountain bike, see MTB
- MTB, see mountain bike
- Mudguard 20
- Mudguard,
 - care for, 176
 - clean, 172
 - position, 29
- Mudguards,
 - check, 168
- N**
- Nameplate, 28
 - position, 29
- Negative deflection, 277
- Nipple holes,
 - check, 183
- Nipple well,
 - check, 183
- O**
- Off-road tyres, 37
- On-board computer, 48
 - clean 171
 - store, 82
 - use, 154
 - position, 49
 - torques, 77
- Operating instructions, 278
- P**
- Pannier rack,
 - care 176
 - change, 149
 - check 168
 - clean, 172
 - inspect, 209
 - use, 148
 - position, 29
- Patent seat post, 43
- Pedal,
 - care for, 178
 - clean, 170
 - fit 92
 - position, 29
- torque, 74
- Pedelec, 276
 - adjust 107
 - after each ride, 170
 - assemble 83
 - before each ride 147, 168
 - check, 180
 - clean 171
 - commission 84
 - initial inspection 198
 - inspect (specialist dealer) 198
 - major inspection 198
 - park 162
 - sell, 93
 - service 175
 - ship, 81
 - store, 82
 - transport, 80
 - unpacking 83
 - use 148
- Placing on the market, 278
- Pressure point, 278
- Profile,
 - position, 36
- Puncture protection belt, 38
 - position, 36
- Push assist,
 - use, 154
- Q**
- Q-Loc, 35
 - position, 35
- Quick release, 278
 - inspect, 211
 - position, 40
- Quick releases,
 - check 168
- R**
- Racing bicycle valve, see Presta valve
- Racing bicycle, 278
- Rear derailleur,
 - care for, 178
 - position 45
 - torque, 73
- Rear frame damper,
 - check 168
 - inspect, 209
 - maintain, 209
- Rear light, 47
 - clean 170
 - position, 29

- Rear wheel brake, 42
 - Rear wheel, see Wheel
 - Rebound adjuster, 35
 - position, 35
 - Rebound adjustment, 64
 - Rebound damping, 34
 - Rebound, 278
 - Rechargeable battery, 278
 - Rechargeable battery, see battery
 - Reflector,
 - position, 29, 31
 - Reflectors,
 - clean 170
 - Riding light, 47
 - adjust, 137
 - check, 169, 193
 - switch off 154
 - switch on 154
 - Rim brake locking lever 41
 - Rim brake,
 - check 187
 - Rim, 39
 - replace, 248
 - position, 36
 - Rims,
 - care for, 177
 - Road tyres, 37
 - Roller brake,
 - brake, 156
- S**
- Saddle, 149
 - change saddle tilt, 114
 - change the seat length, 117
 - check 194
 - clean, 172
 - determine saddle height, 115, 117
 - use, 149
 - position, 29
 - Safety guards, 20
 - Sag setting wheel, 35
 - position, 35
 - Sag,
 - setting wheel, 35
 - Sclaverand valve, see Presta valve
 - Screen,
 - battery level indicator, 65
 - Seat post, 43, 278
 - care for, 177
 - check 169, 194
 - clean, 172
 - inspect, 213
 - patent seat post 43
 - suspension seat post 44
 - position, 29
 - remote control position, 49
 - remote control torque, 74
 - torque, 74
 - Selection menu. 139
 - Selector button, 51
 - Settings,
 - change 139
 - open menu, 51
 - Shifter,
 - care for, 178
 - clean 173
 - position, 49
 - torque, 72
 - Shut-off speed, 278
 - Slicks, 37
 - Slippage, 278
 - Software version,
 - display, 142
 - Spare part, 278
 - Spoke nipples, 39
 - care for, 177
 - position, 36
 - Spokes, 39
 - check, 183
 - replace 248
 - position, 36
 - Stanchion, 35
 - position, 35
 - Steering headset 30
 - Steering headset,
 - grease, 210
 - inspect, 210
 - Steering system, 30
 - Stem, 30
 - adjust 148
 - care for, 176
 - check 194
 - check, 93
 - clean, 172
 - inspect, 210
 - position, 29
 - torque, 74
 - Suspension fork, 278
 - clean 170
 - inspect, 212
 - service, 170
 - Suspension seat post, 44
 - care for, 177
 - clean, 170
 - Switching element,
 - clean 173
- T**
- System message, see error message
 - Time format,
 - set, 140
 - Torques, 72
 - Total deflection 278
 - Tour data,
 - reset, 142
 - Trailer, 144
 - Transportation, 79
 - Transporting, see Transportation
 - Tread, 37
 - position, 36
 - Tube,
 - replace, 248
 - Tyre design types, 36
 - Tyre inflation, see tyre pressure
 - Tyre pressure, 36
 - change, 180
 - check, 180
 - display, 58
 - Tyre size, 36
 - Tyre,
 - position, 36
 - Tyres, 36
 - check, 182
 - clean 173
 - convert 145
 - airless 145
 - tubeless 145
 - Tyres,- Tube-type tyres 36
- U**
- Units, 140
 - change, 59
 - set, 140
 - USB cover,
 - check 169
- V**
- V- Brake brake,
 - torque, 75
 - Values,
 - reset, 59
 - Valve, 36
 - Dunlop valve, 39
 - position, 36
 - Presta valve, 39
 - Schrader valve, 39
 - V-brake,
 - adjust 187
 - Vibration feedback,
 - adjust 142

W

Wear, 278

Weight, 79

Wheel, 36, 279

- check concentricity 168

- check, 180

- fit 85, 86, 89

Winter break, see Break in operation

Work environment, 279

Y

Year of manufacture, 279